



BANEDANMARK

TIB-S

Strækningsoversigter

26-11 Gældende fra 21.06.2026

TIB-S

Nyt om TIB-S pr. 21.06.2026

11. København H/Hvidovre Fjern - Peberholm

Side **181** og side **182**

Nye sporskifter ilagt, aflåst.

23. Fredericia - (Børkop)

Side **213**

Telefonnummer til FC og GSM-R tilrettet.

TIB-S udgives af:

Banedanmark
Carsten Niebuhrs Gade 43
1577 København V

E-mail: trafikaleregler@bane.dk

Dette er et elektronisk dokument. I tilfælde af uoverensstemmelse(r) mellem en papirkopi af dokumentet og det elektroniske dokument, er det til enhver tid den elektroniske udgave, som er gyldig. Et elektronisk dokument forudsættes vist på et korrekt indstillet medie uden farvefejl. Den gyldige elektroniske version kan altid findes på www.bane.dk

Indholdsfortegnelse:

Strækning 1:	København H - Fredericia/Taulov	5
Strækning 2:	Ringsted - (Lundby)	77
Strækning 4:	Roskilde - (Gadstrup) og (Holme-Olstrup) - Næstved	90
Strækning 5:	Roskilde - Kalundborg	98
Strækning 6:	København H - Vigerslev - (Avedøre Havnevej) og (Bjæverskov) - Ringsted	120
Strækning 7:	(Svanemøllen) - Østerport	140
Strækning 10:	København H - Helsingør	144
Strækning 11:	København H/Hvidovre Fjern - Peberholm	171
Strækning 21:	Odense - Svendborg	194
Strækning 23:	Fredericia - (Børkop)	210
Strækning 26:	Fredericia - Padborg	214
Strækning 28:	Sønderborg - Tinglev	241
Strækning 29:	Lunderskov - (Vejen)	253
Strækning 30:	Tønder - Tønder Grænse	257

1. København H - Fredericia / Taulov

Strækningshastighed:

Delstrækning	Strækningshastighed (km/t)
København H - Fredericia/Taulov	180

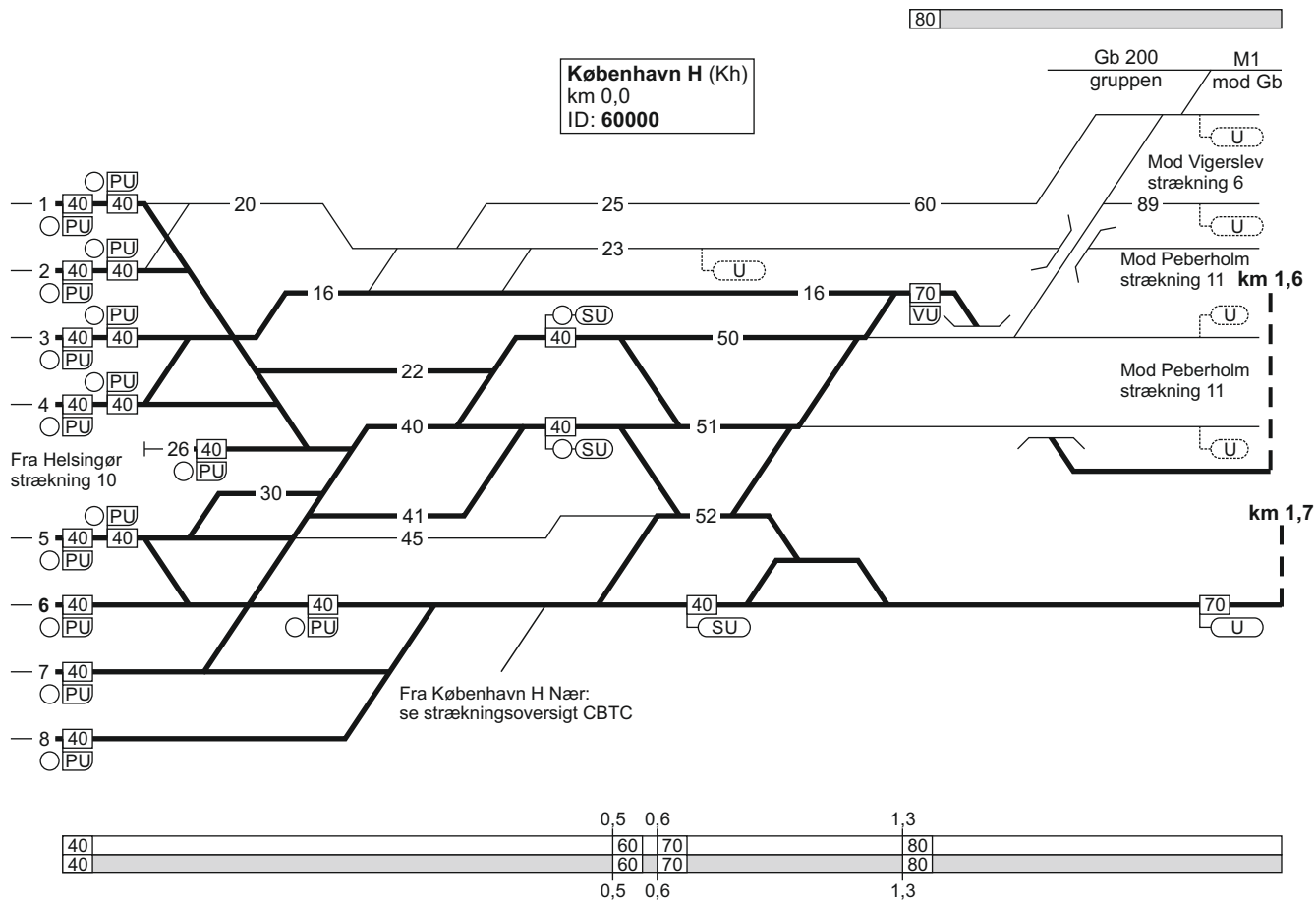

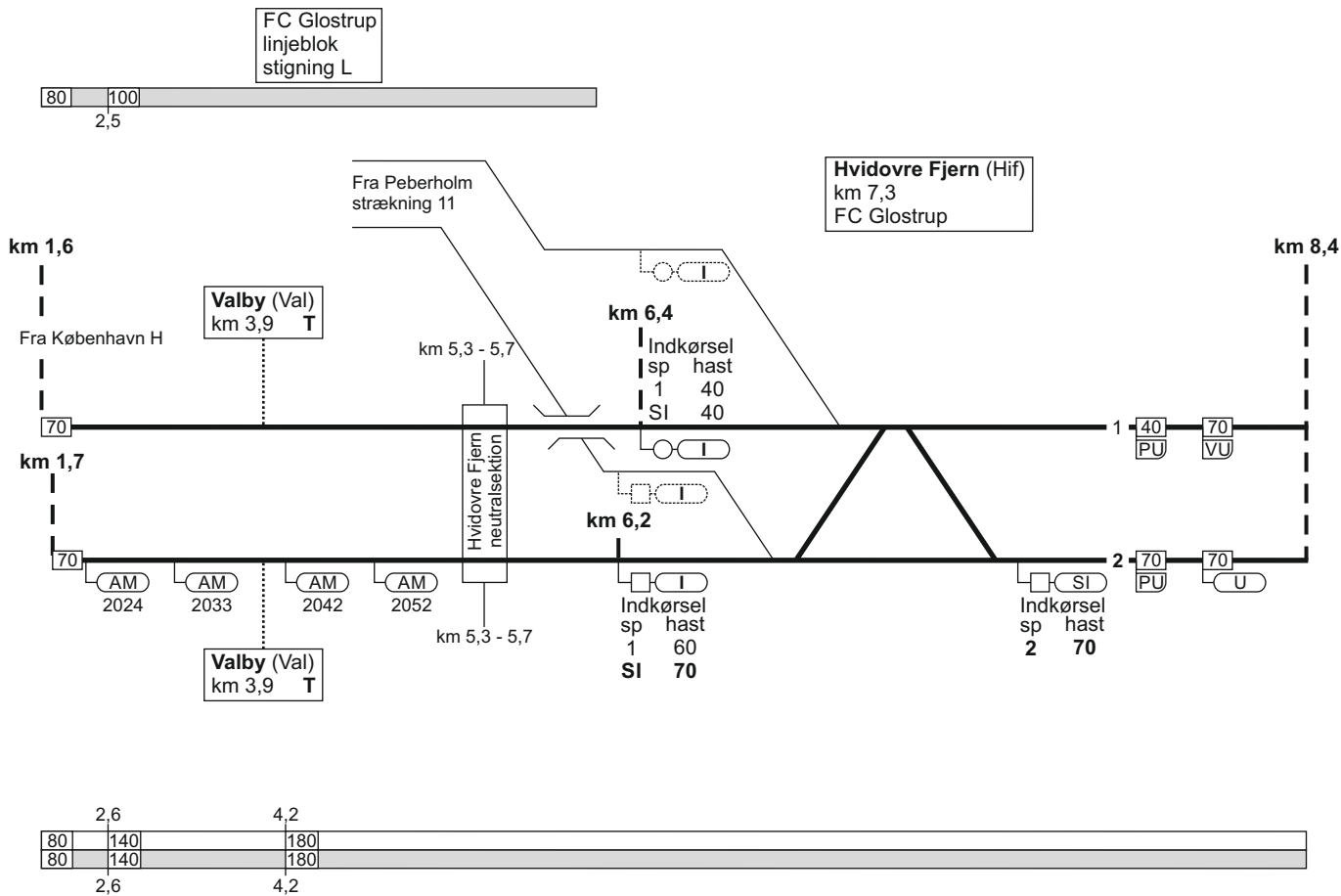

FC Glostrup
linjeblok
stigning M

FC Glostrup
linjeblok
stigning H

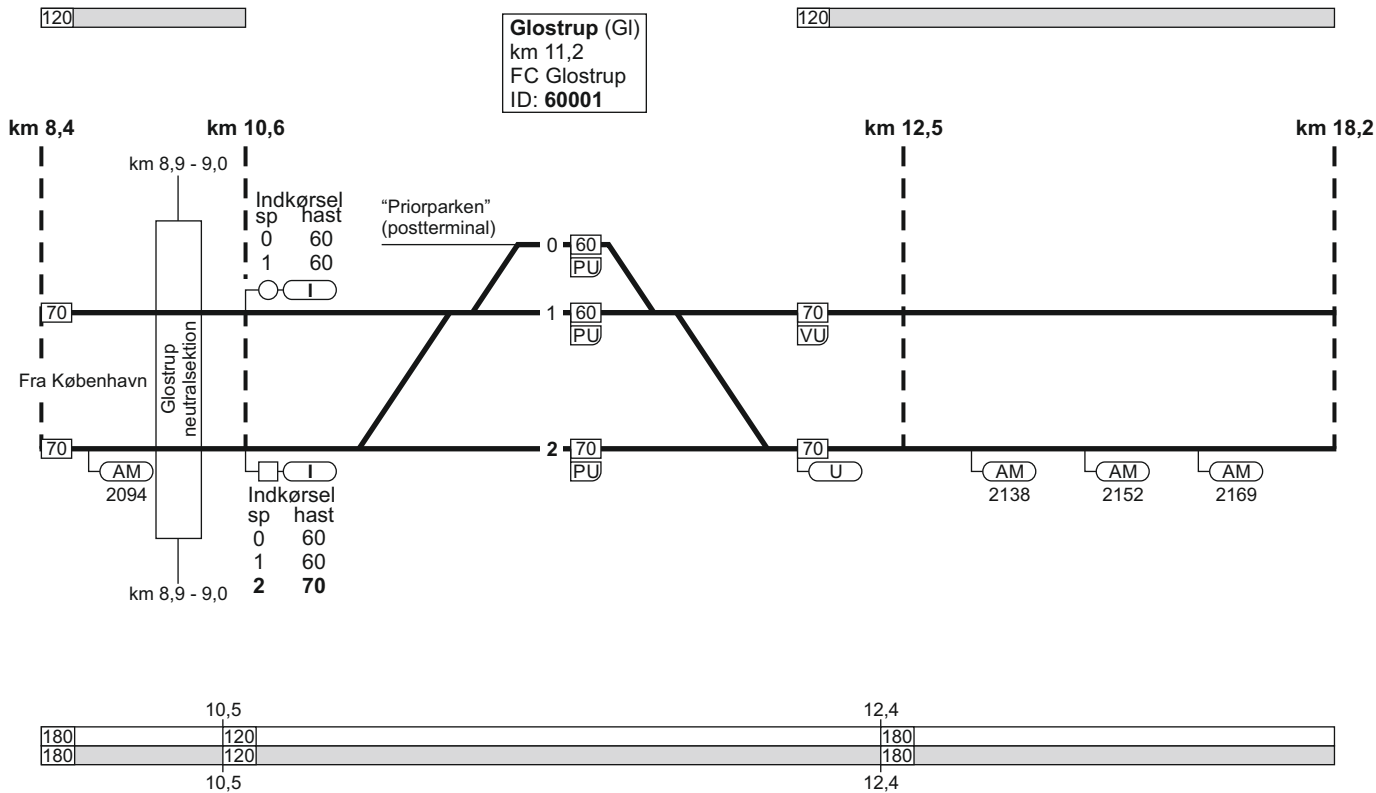

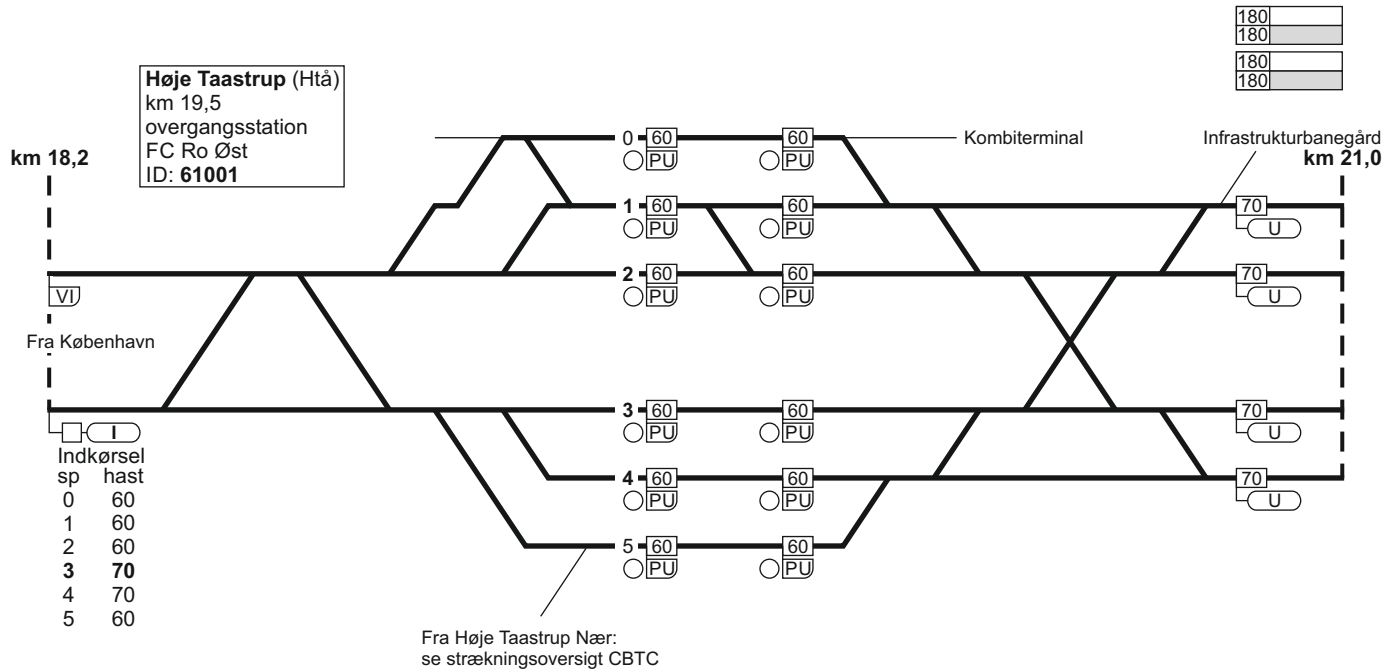

180	
180	
180	
180	

18,5									20,7
180	120								180
180	120								180
18,5									
		100	120						180
		100	120						180
		19,0	19,1						20,7

FC Ro Øst
linjeblok / vekselspor
stigning M

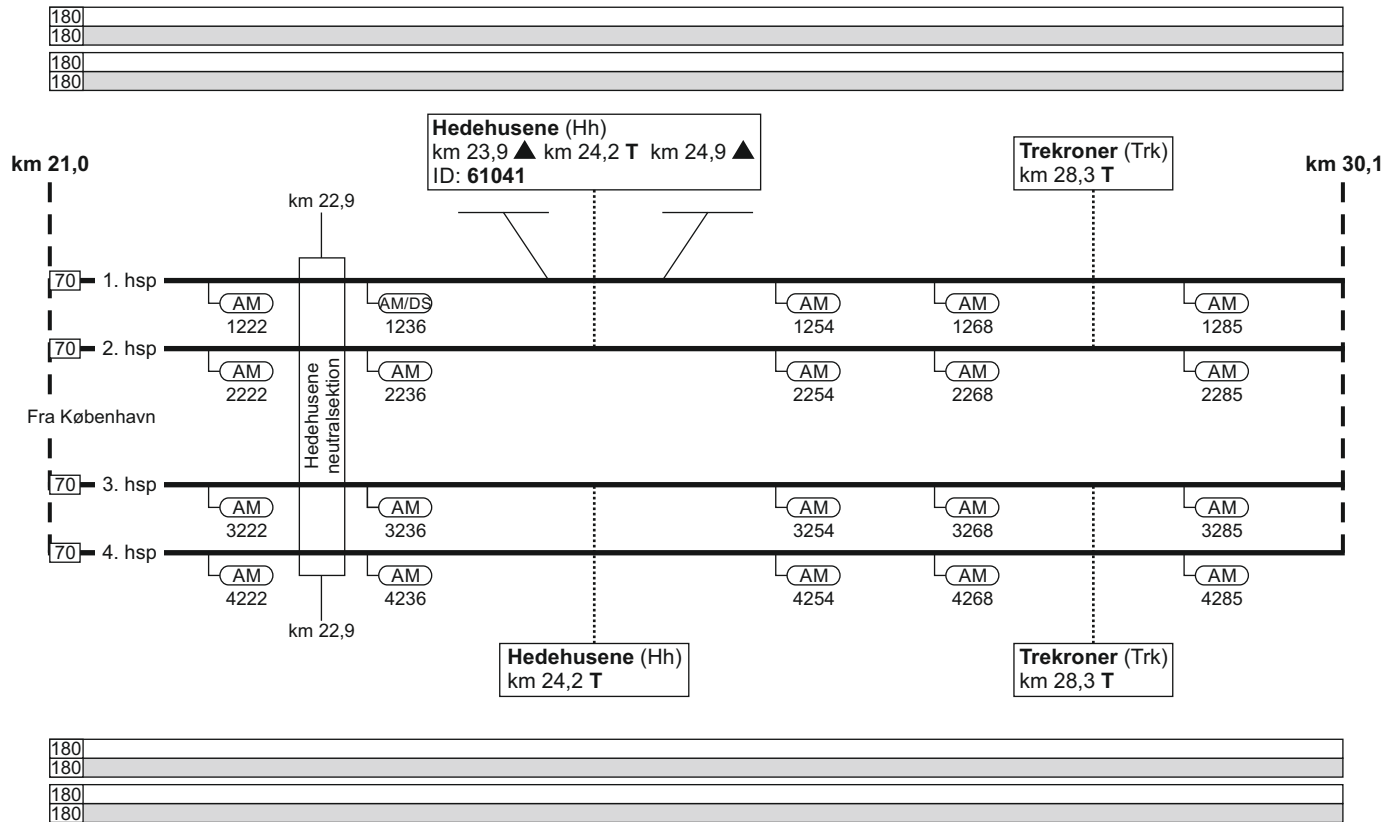

Roskilde (Ro)
 km 31,3
 overgangsstation
 ID: 61000

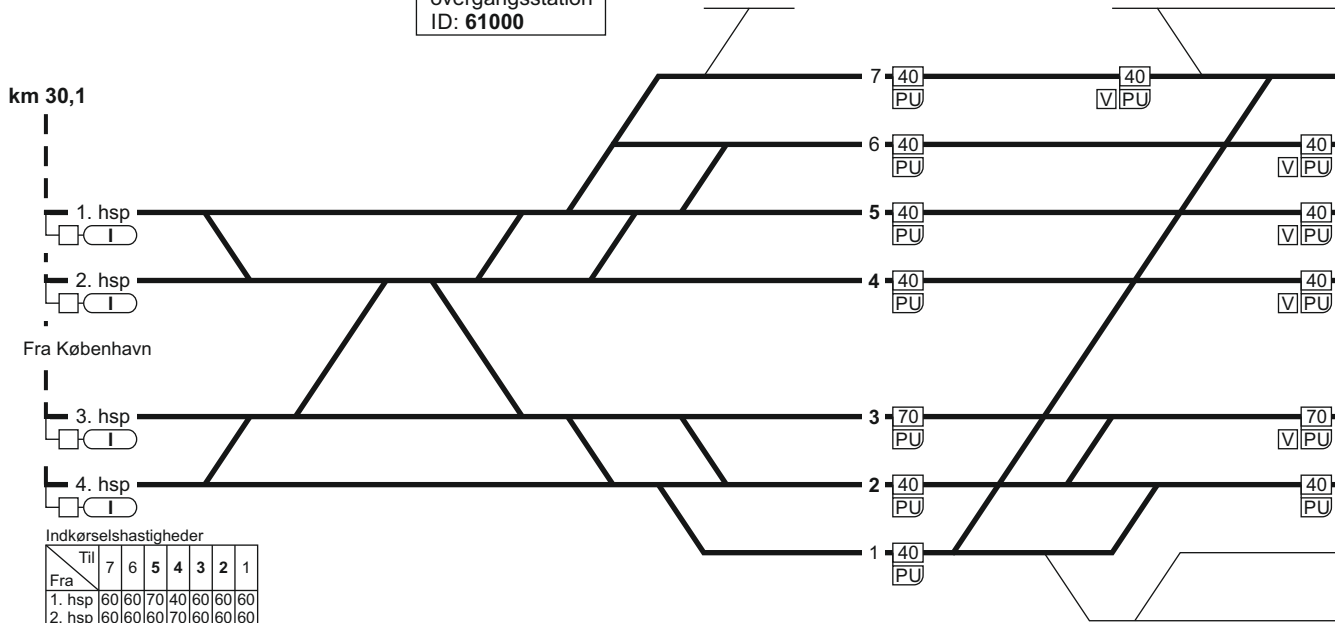

km 30,1

1. hsp
 2. hsp

Fra København

3. hsp
 4. hsp

Indkørselshastigheder

Fra \ Til	7	6	5	4	3	2	1
1. hsp	60	60	70	40	60	60	60
2. hsp	60	60	60	70	60	60	60
3. hsp	60	60	60	40	70	60	60
4. hsp	60	60	60	40	70	70	60

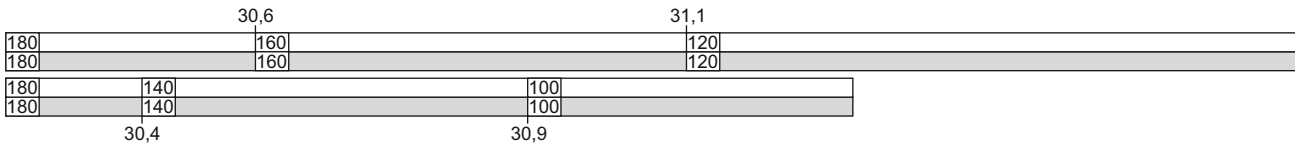

Roskilde (Ro)
 km 31,3
 overgangsstation
 ID: 61000

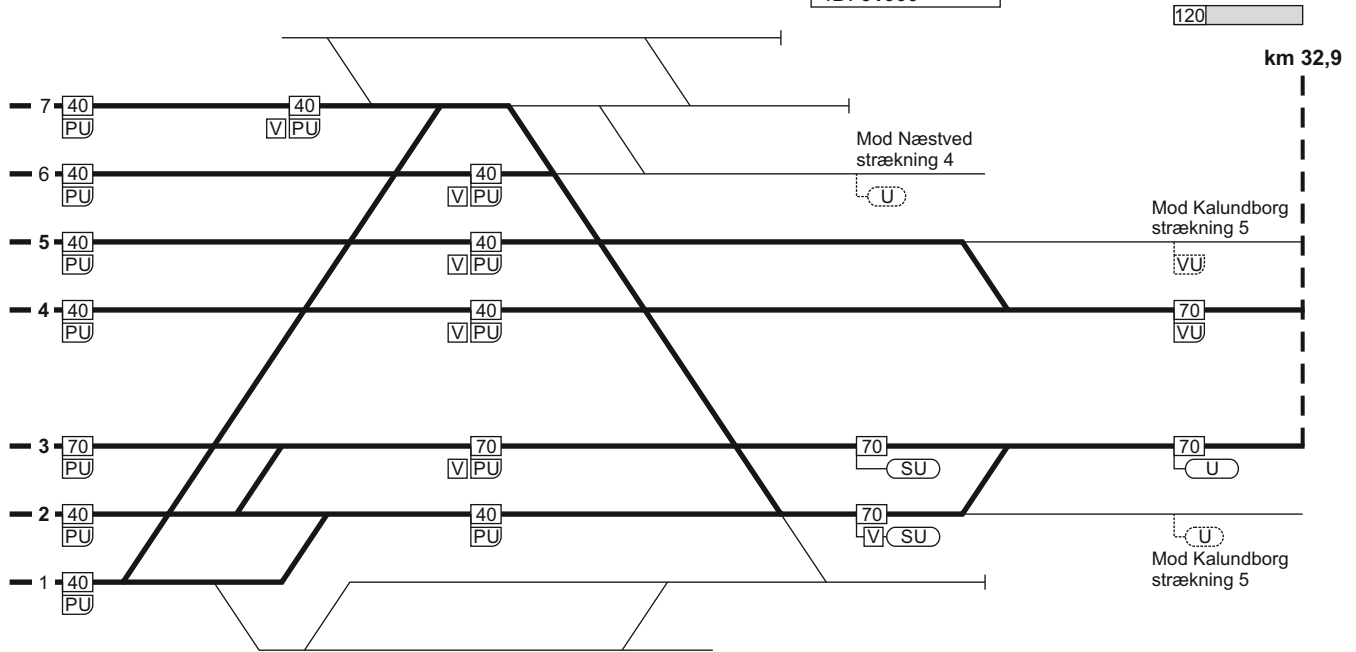

	32,0	32,3
120	140	180
120	140	180
100	32,0	32,3
100		

FC Ro Midt
linjeblok
stigning L

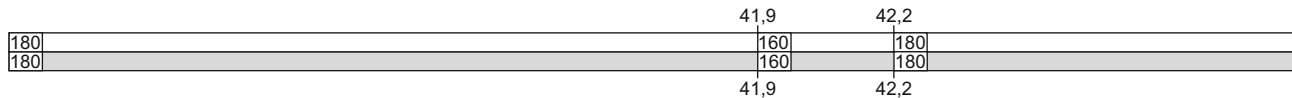
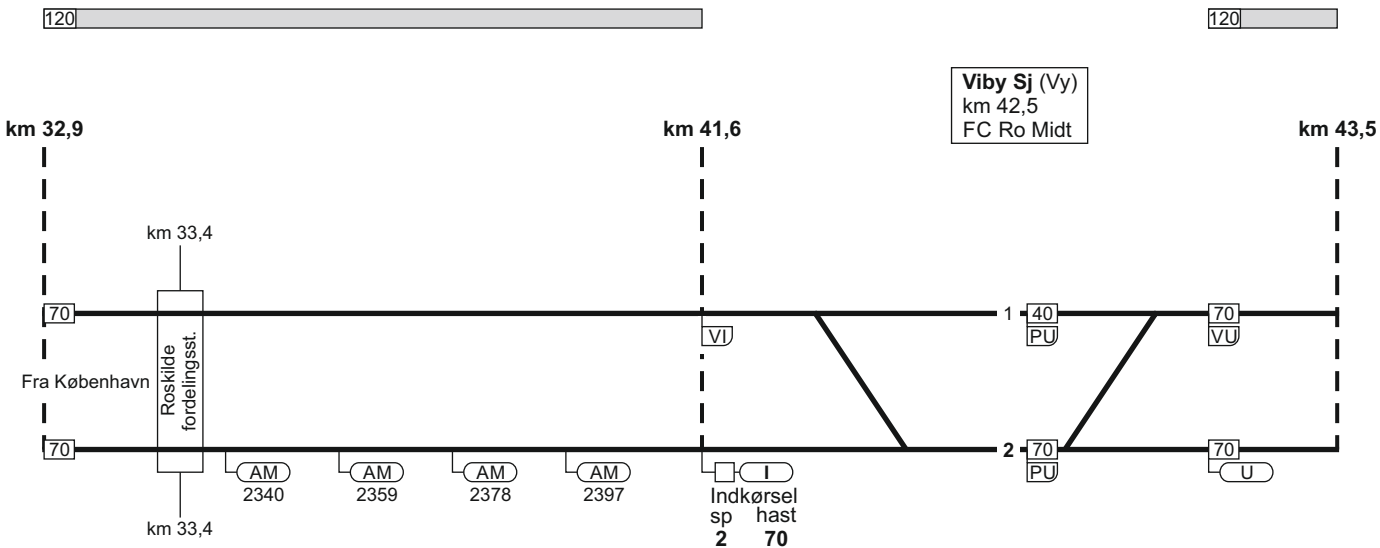

FC Ro Midt
linjeblok
stigning L

FC Ro Midt
linjeblok
stigning M

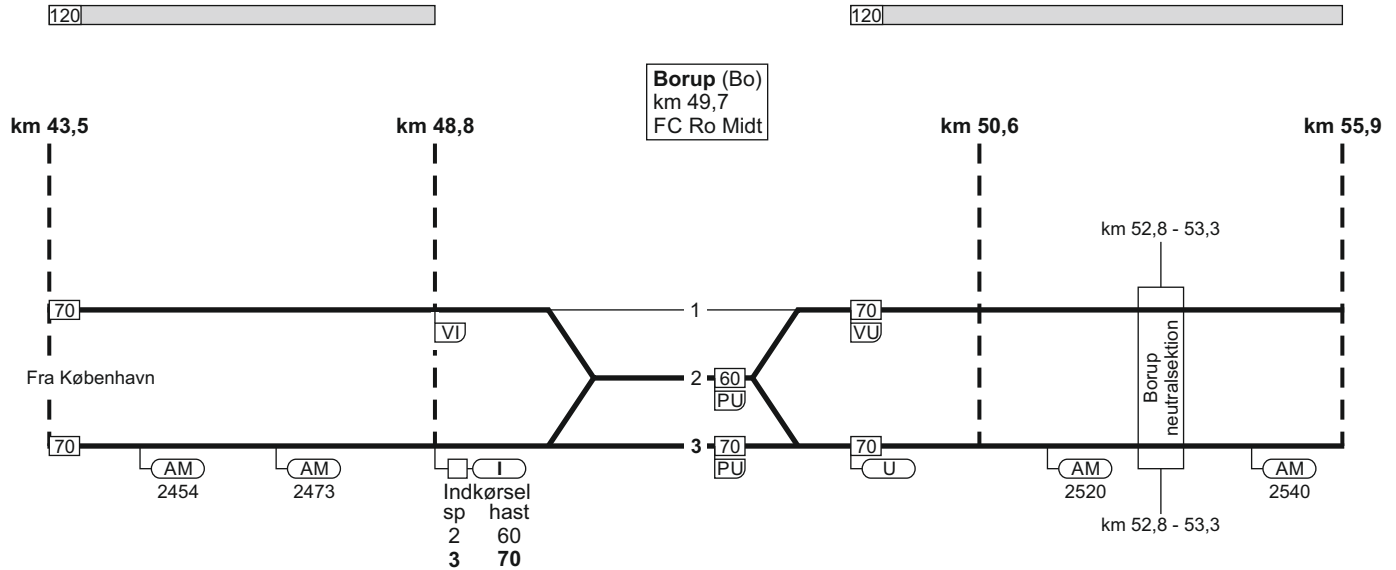

FC Ro Midt
linjeblok
stigning L

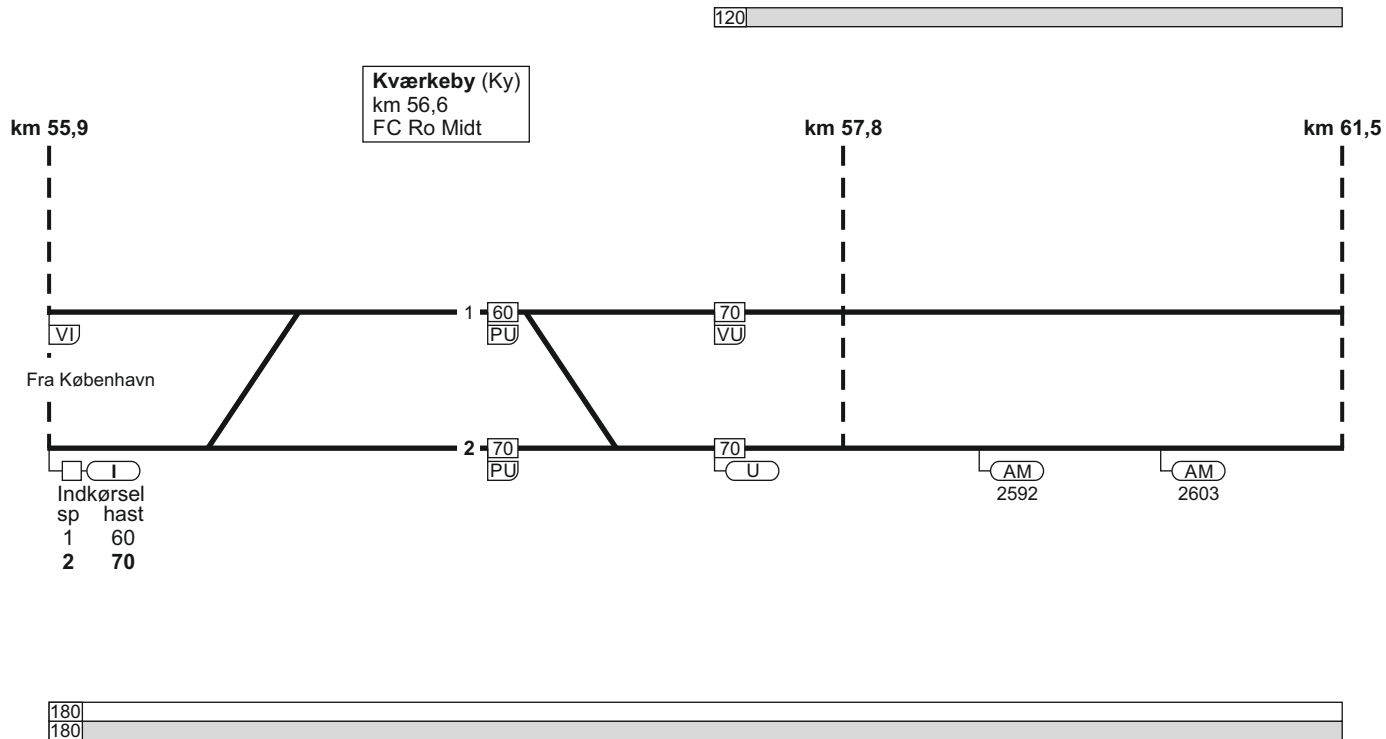

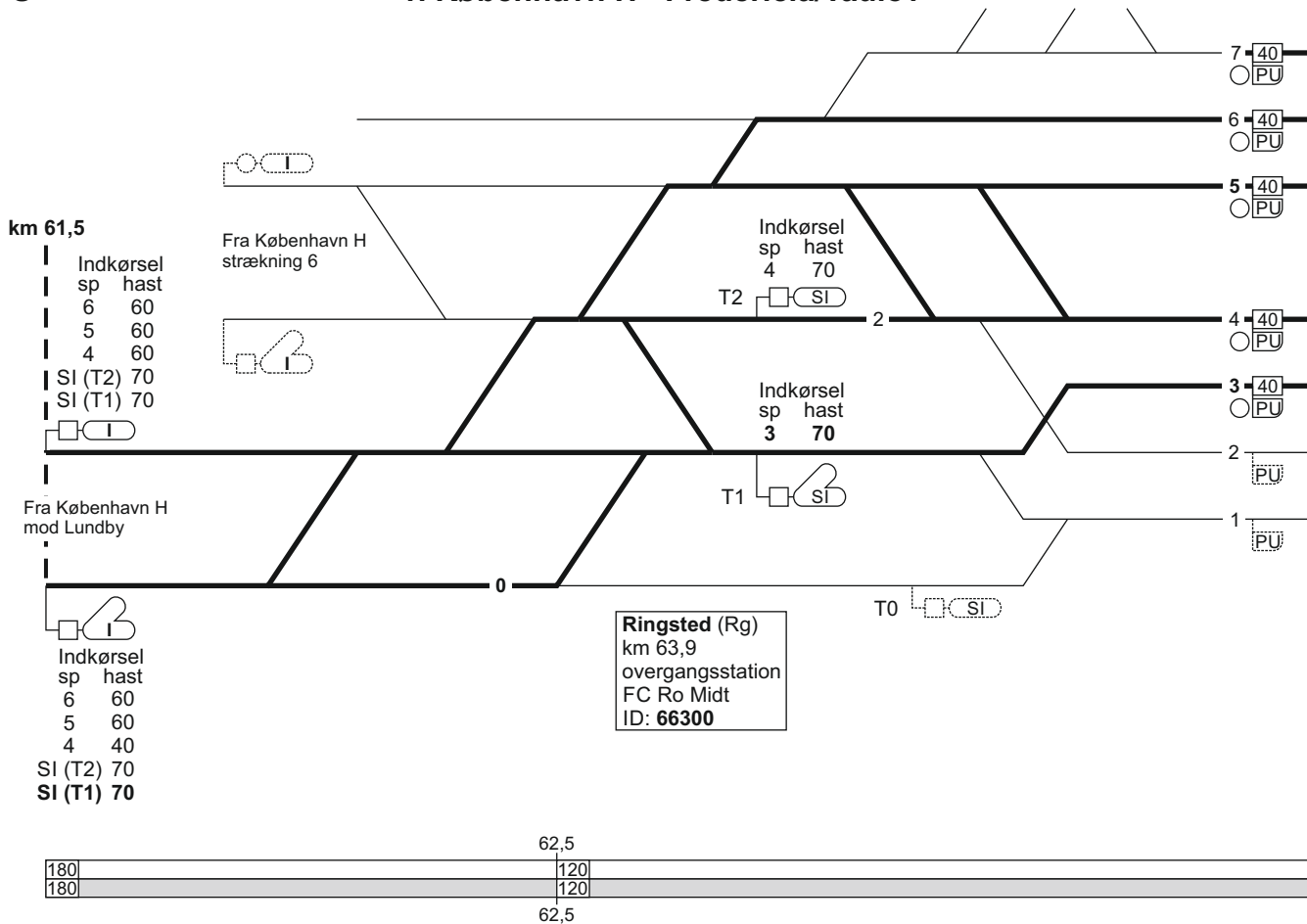

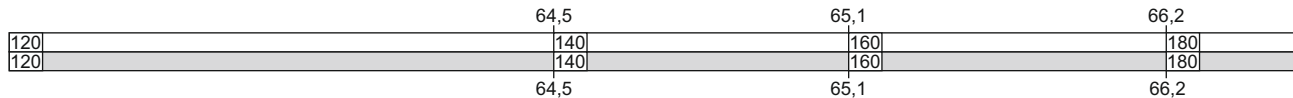
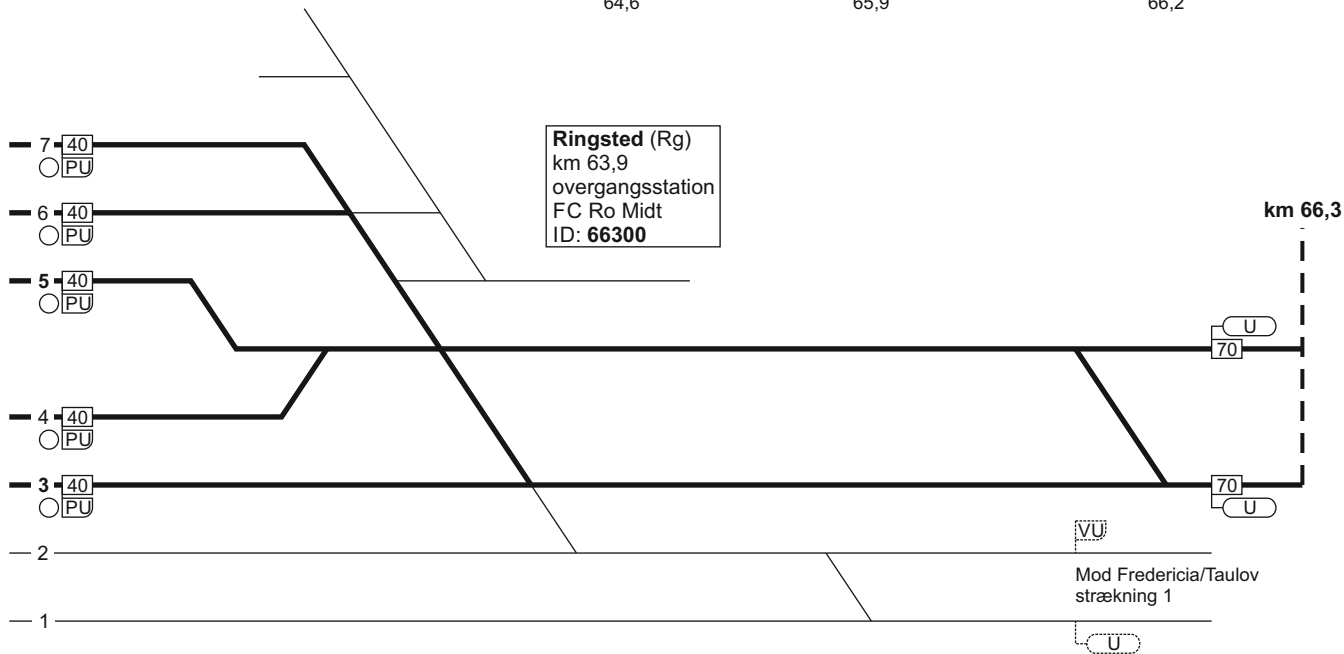
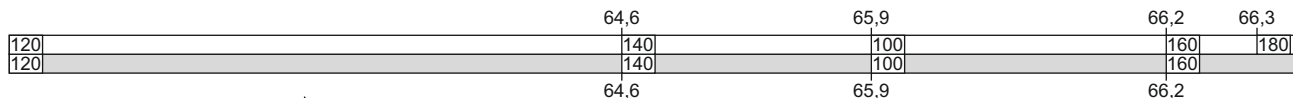

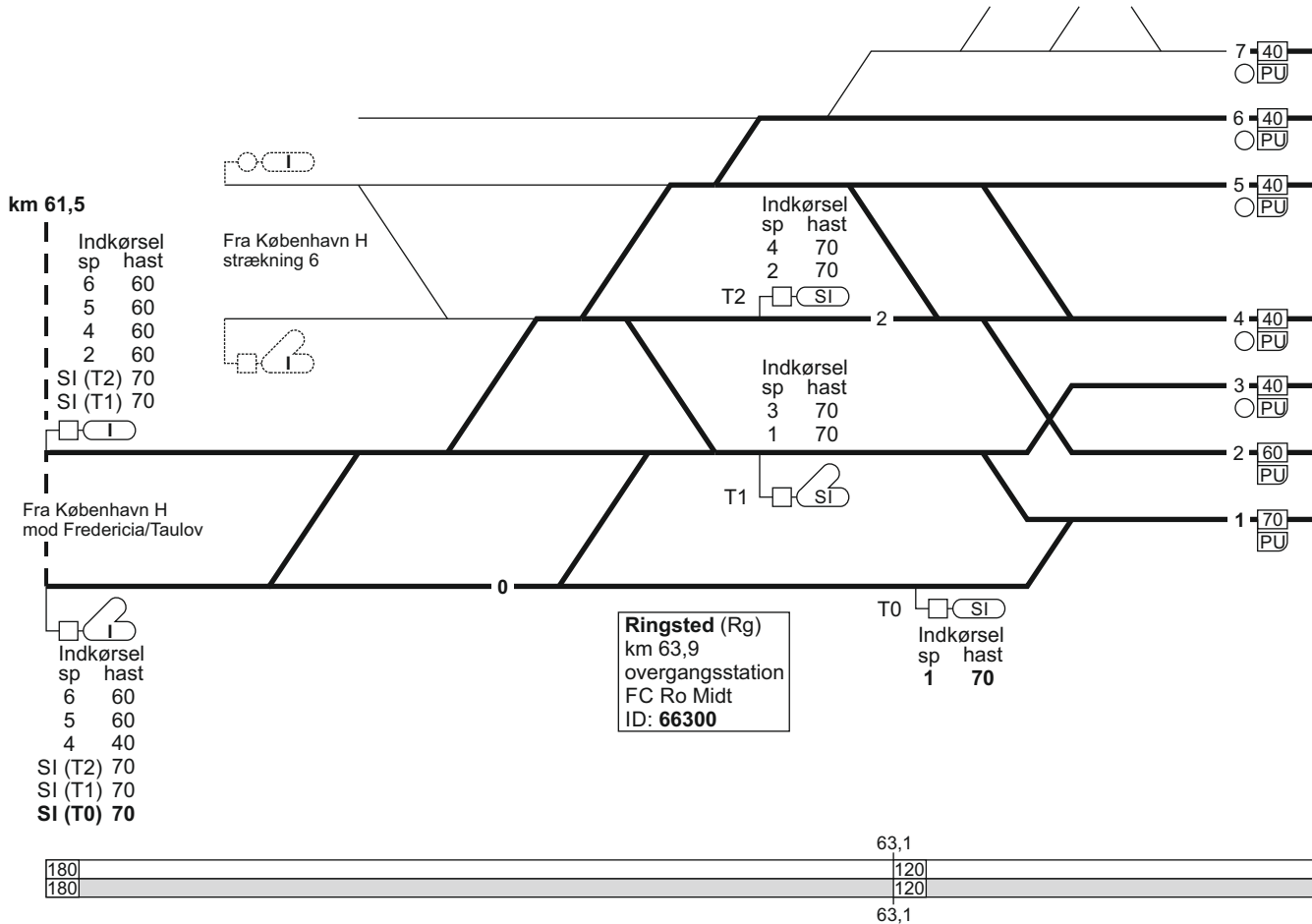

120

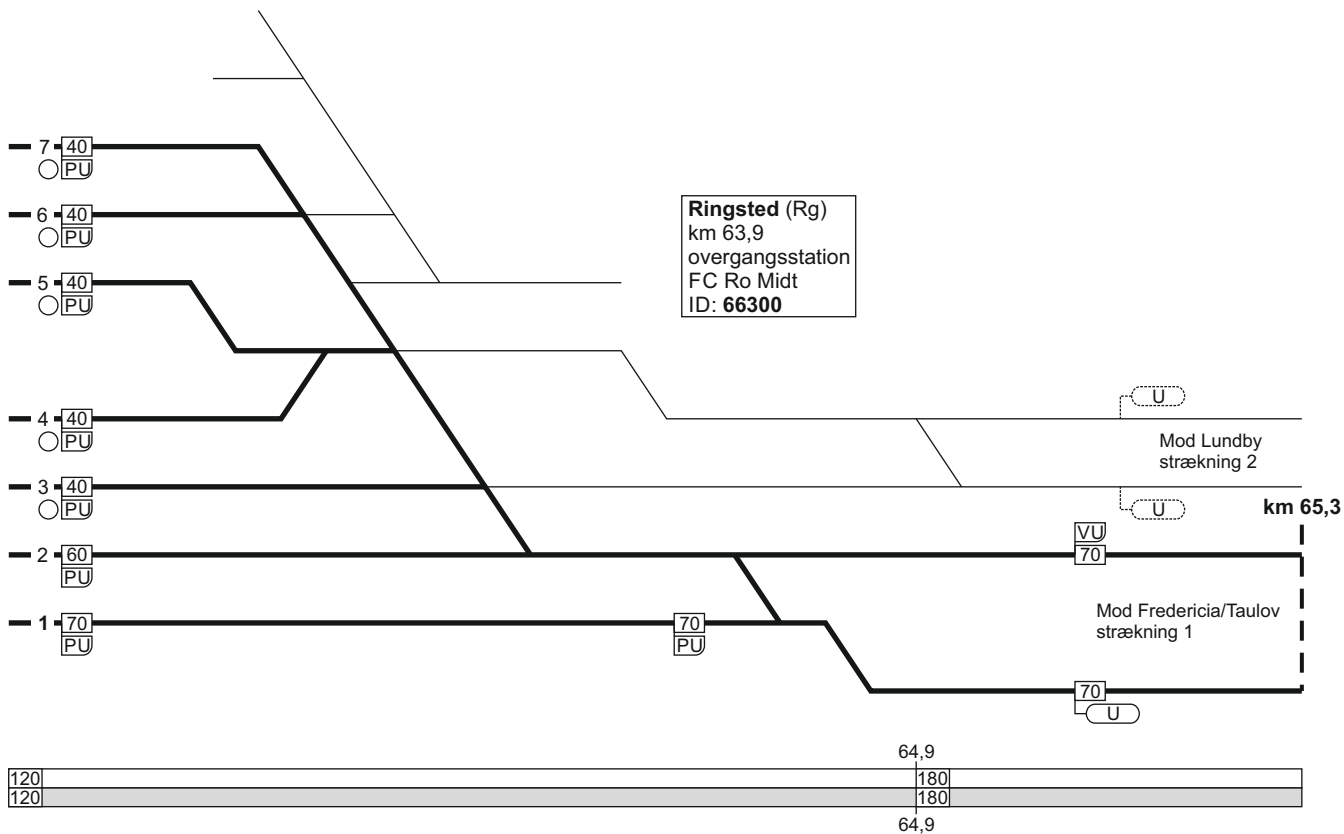

FC Ro Vest
linjeblok
stigning M

FC Ro Vest
linjeblok
stigning M

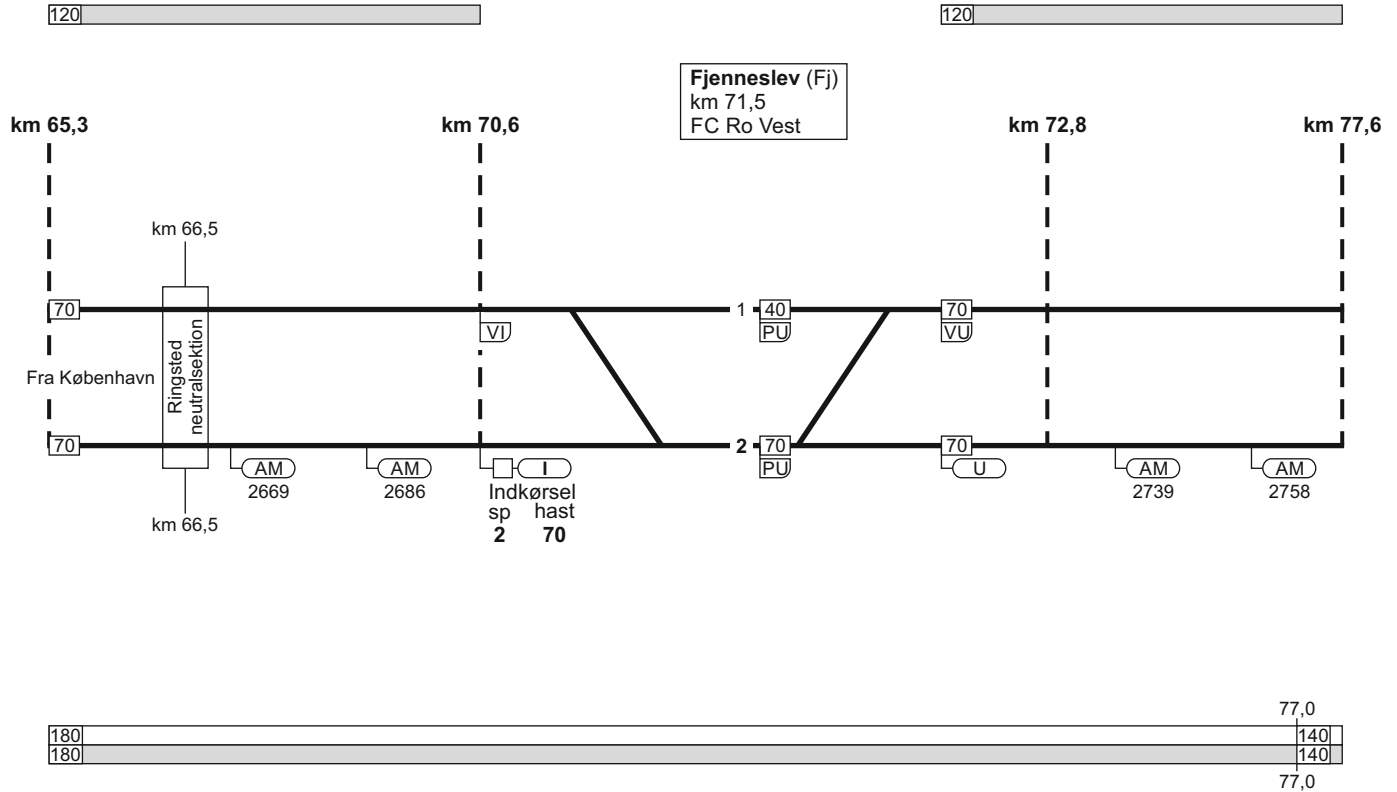

FC Ro Vest
linjeblok
stigning L

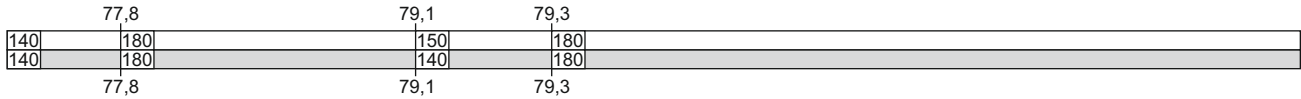
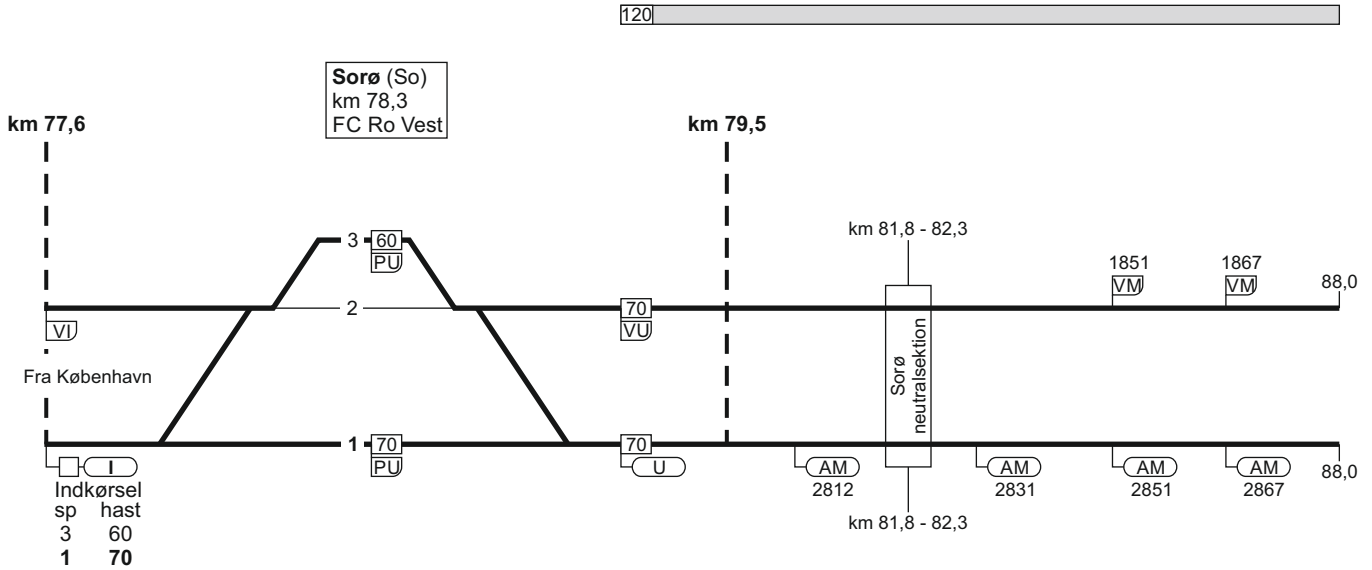

FC Ro Vest
linjeblok
stigning L

91,6



Slagelse (Sg)
km 92,9
overgangsstation
FC Ro Vest
ID: 61051



km 91,7

Indkørsel	sp	hast
1		60
2		70
3		60
4		60

km 94,2

88,0
70

Fra København

88,0
70

AM
2885

AM
2903

Indkørsel	sp	hast
1		60
2		60
3		70
4		60

1 60
PU

2 60
PU

60
PU

70
VU

3 70
PU

70
PU

70
U

4 60
K|PU

60
U

5 40
PU

km 0,9
Mod Tølløse
Lokaltog

*) Mod Tølløse:
Bogstavviser = H

90,6

91,9

94,0



90,6

91,9

94,0

FC Ro Vest
linjeblok
stigning M

FC Ro Vest
linjeblok
stigning L

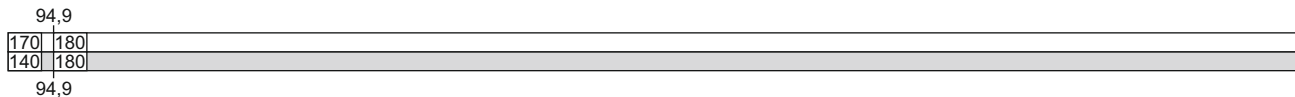
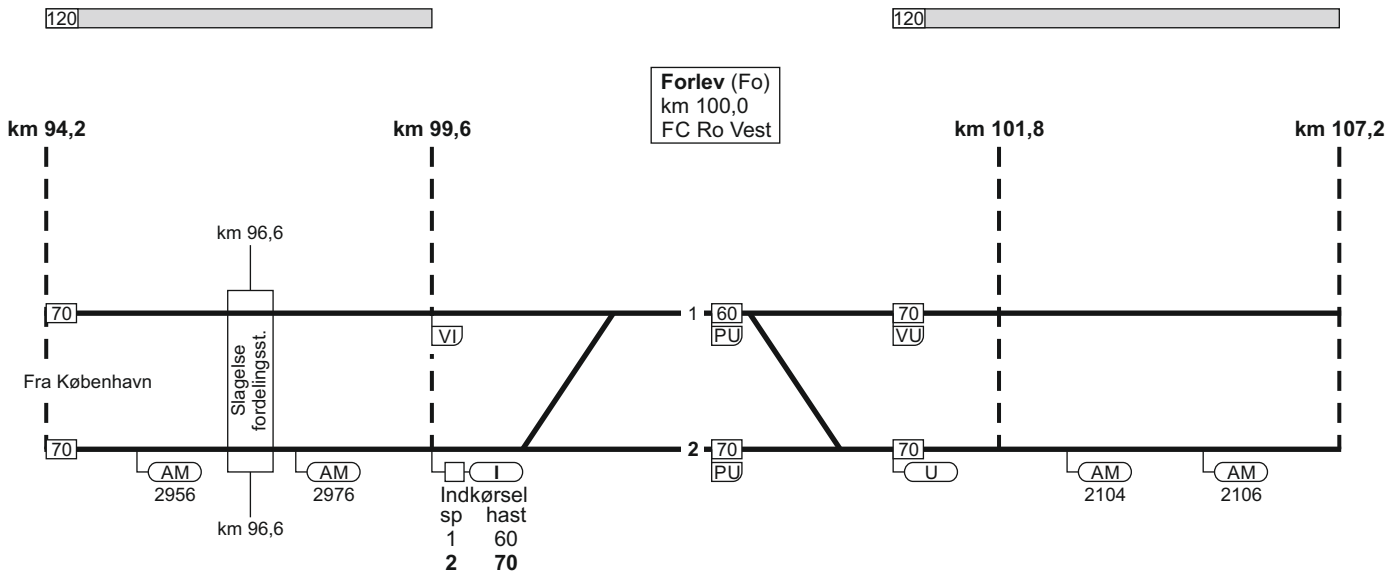

180
180

Kørsør (Kø)
 km 108,3
 FC Ro Vest
 ID: 61200

km 107,2

km 109,9

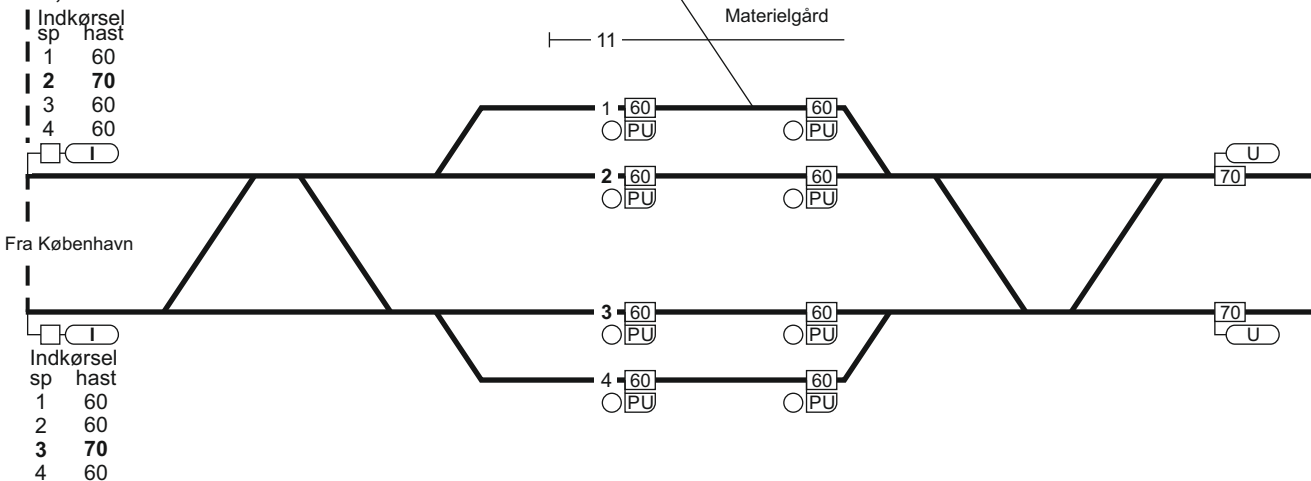

180
180

FC Ro Vest
linjeblok / vekselspor
stigning D

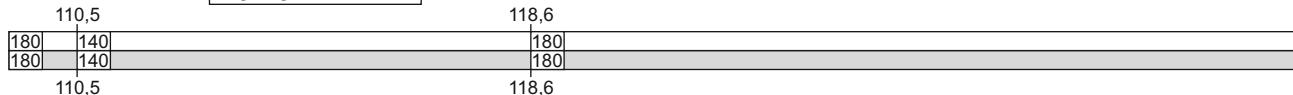

Sprogø (Spr)
km 120,2
FC Ro Vest

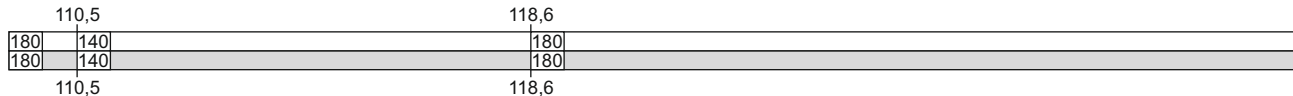
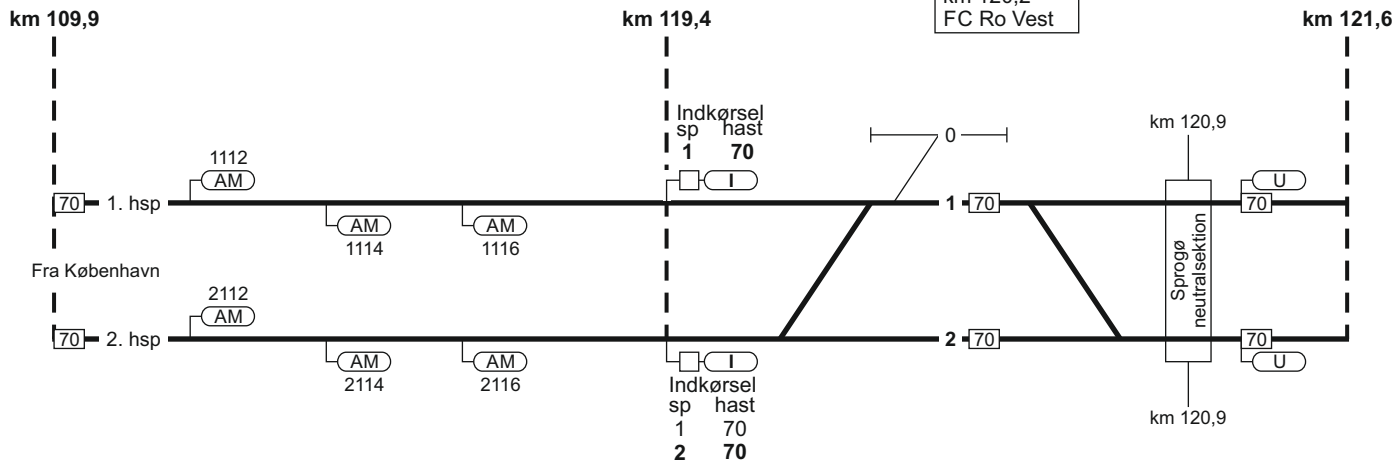

FC Ro Vest
linjeblok / vekselspor
stigning F

180
180

120

Nyborg (Ng)
km 131,6
FC Ro Vest
ID: 61300

km 121,6

km 129,8

km 133,0

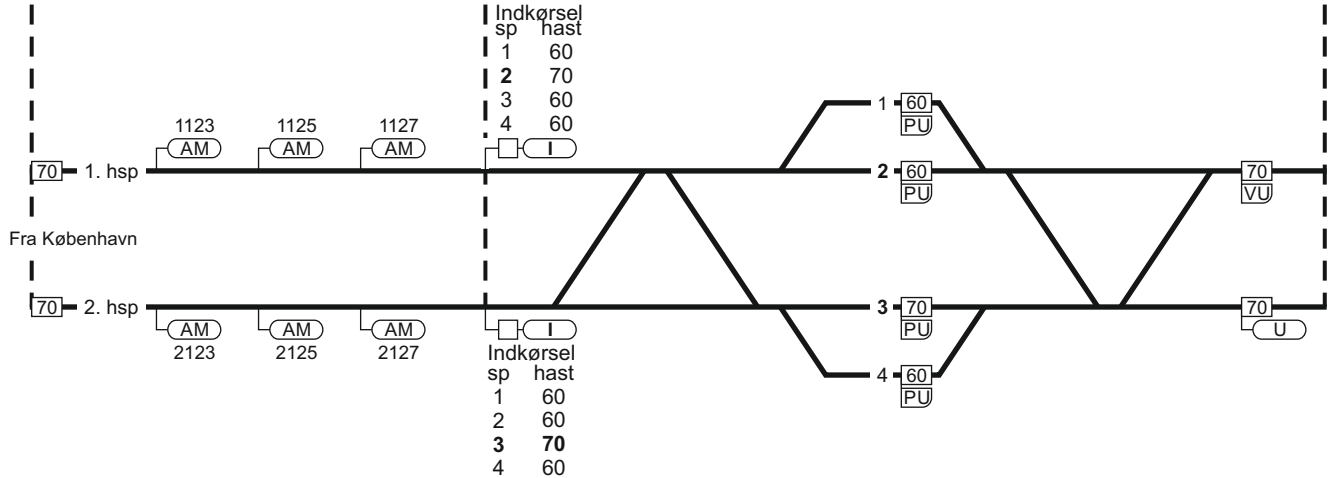

180
180

FC Ro Vest
linjeblok
stigning F

FC Ro Vest
linjeblok
stigning L

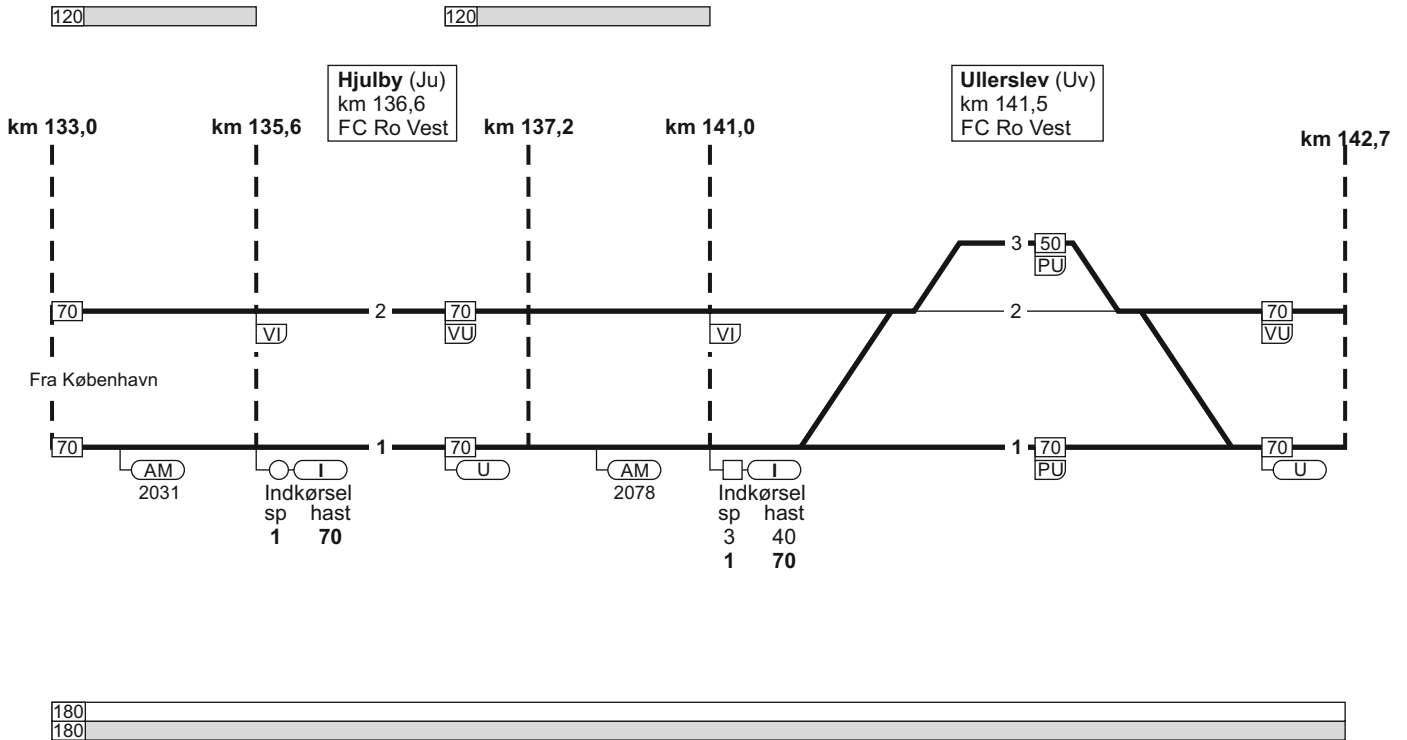

FC Ro Vest
linjeblok
stigning K

FC Ro Vest
linjeblok
stigning H

120

120

Marslev (Mv)
km 151,0
FC Ro Vest

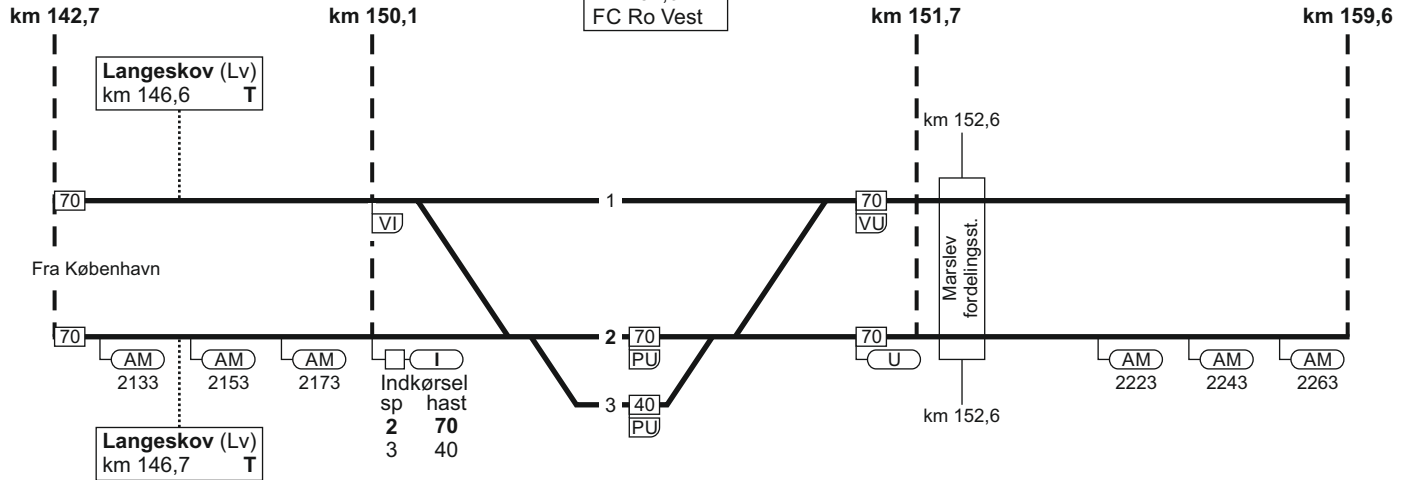

180
180

Odense (Od)
 km 160,3
 overgangsstation
 ID: 66800

100

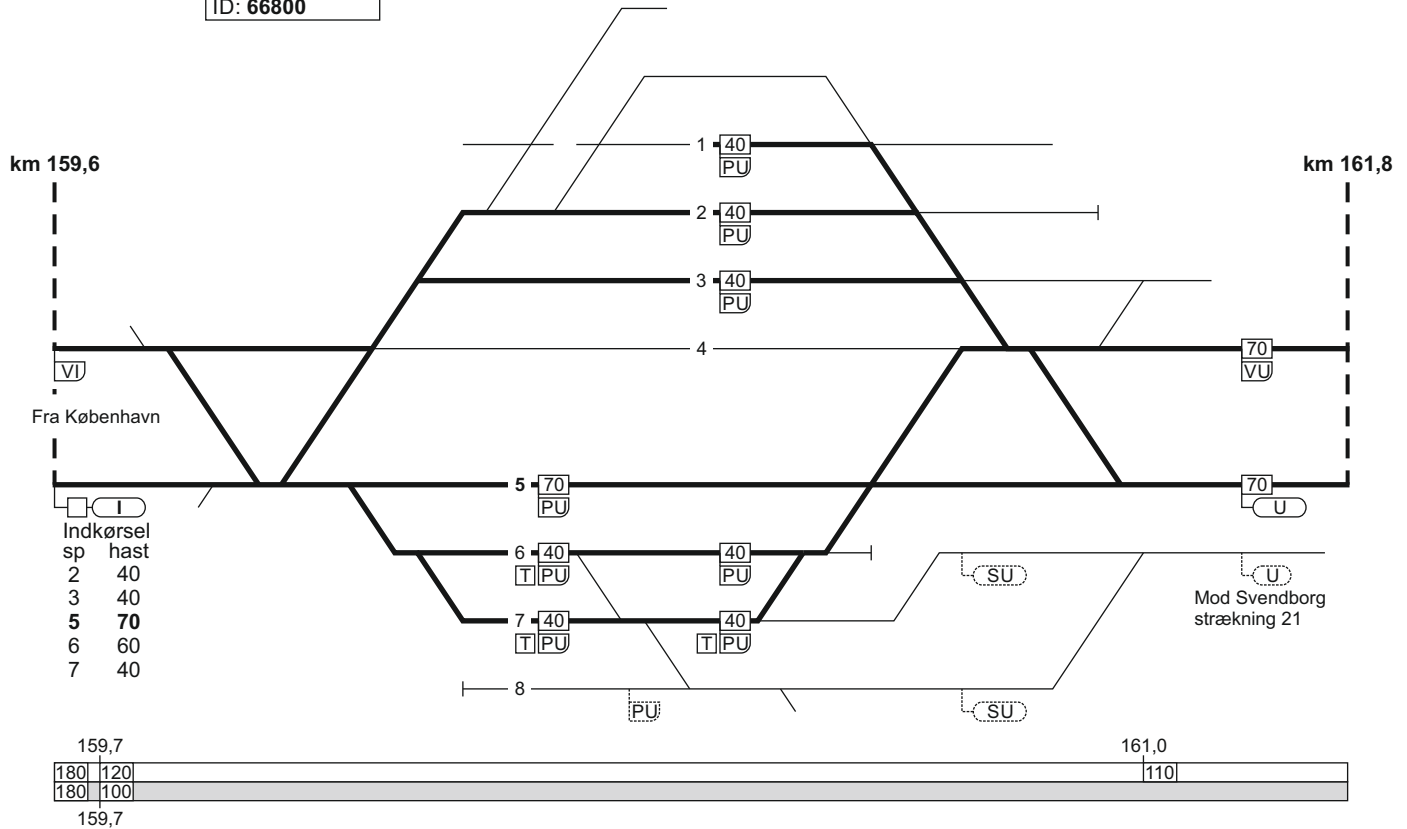

FC Fa Øst
linjeblok
stigning G

FC Fa Øst
linjeblok
stigning G

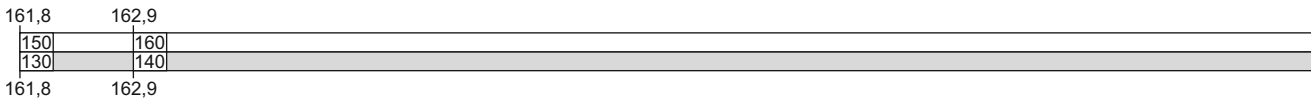
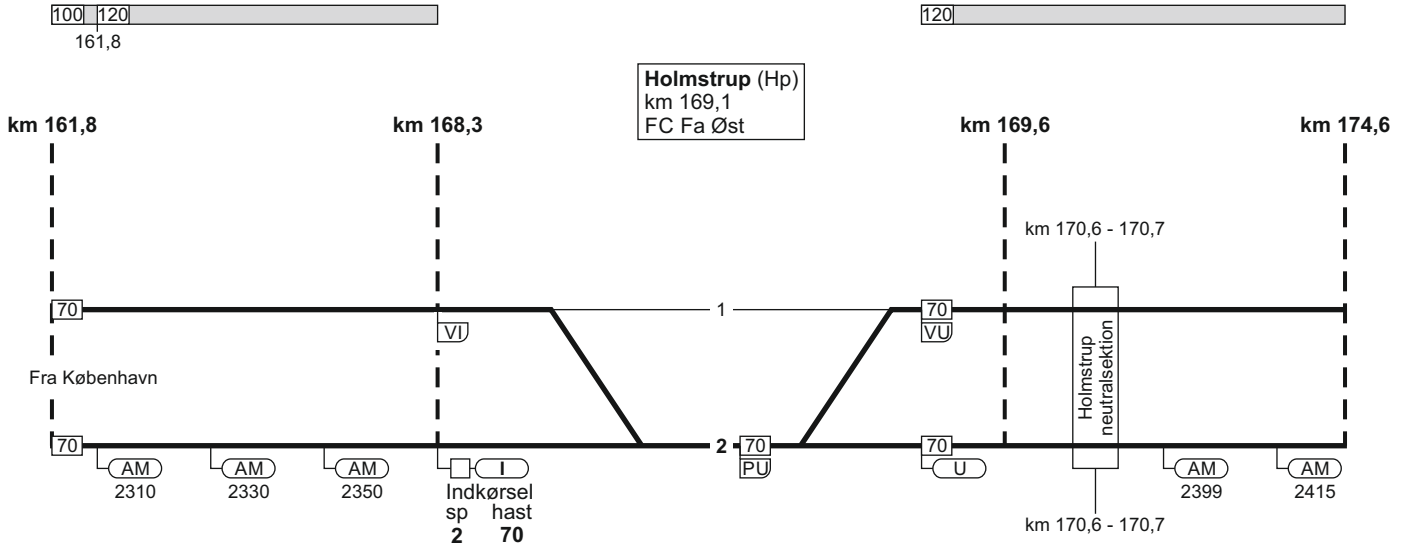

FC Fa Øst
linjeblok
stigning M

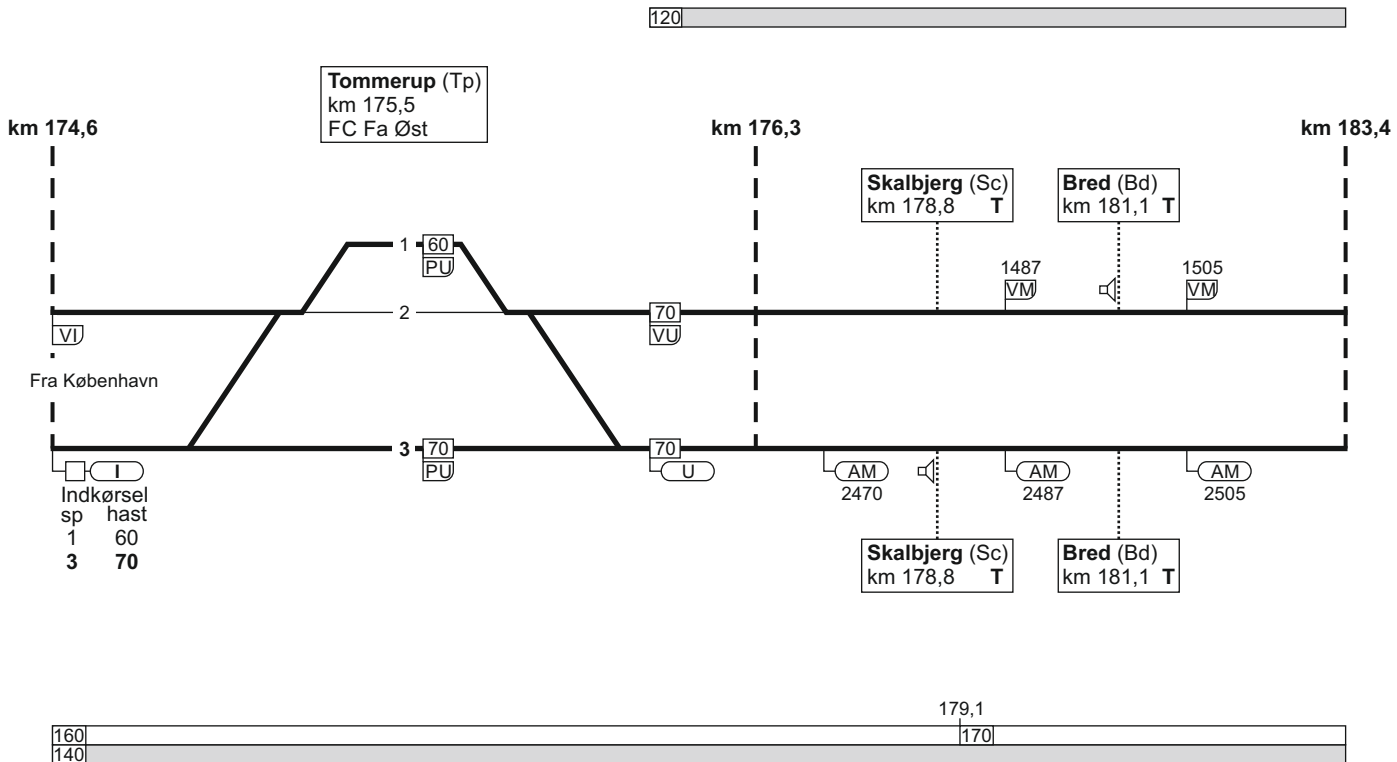

FC Fa Øst
linjeblok
stigning G

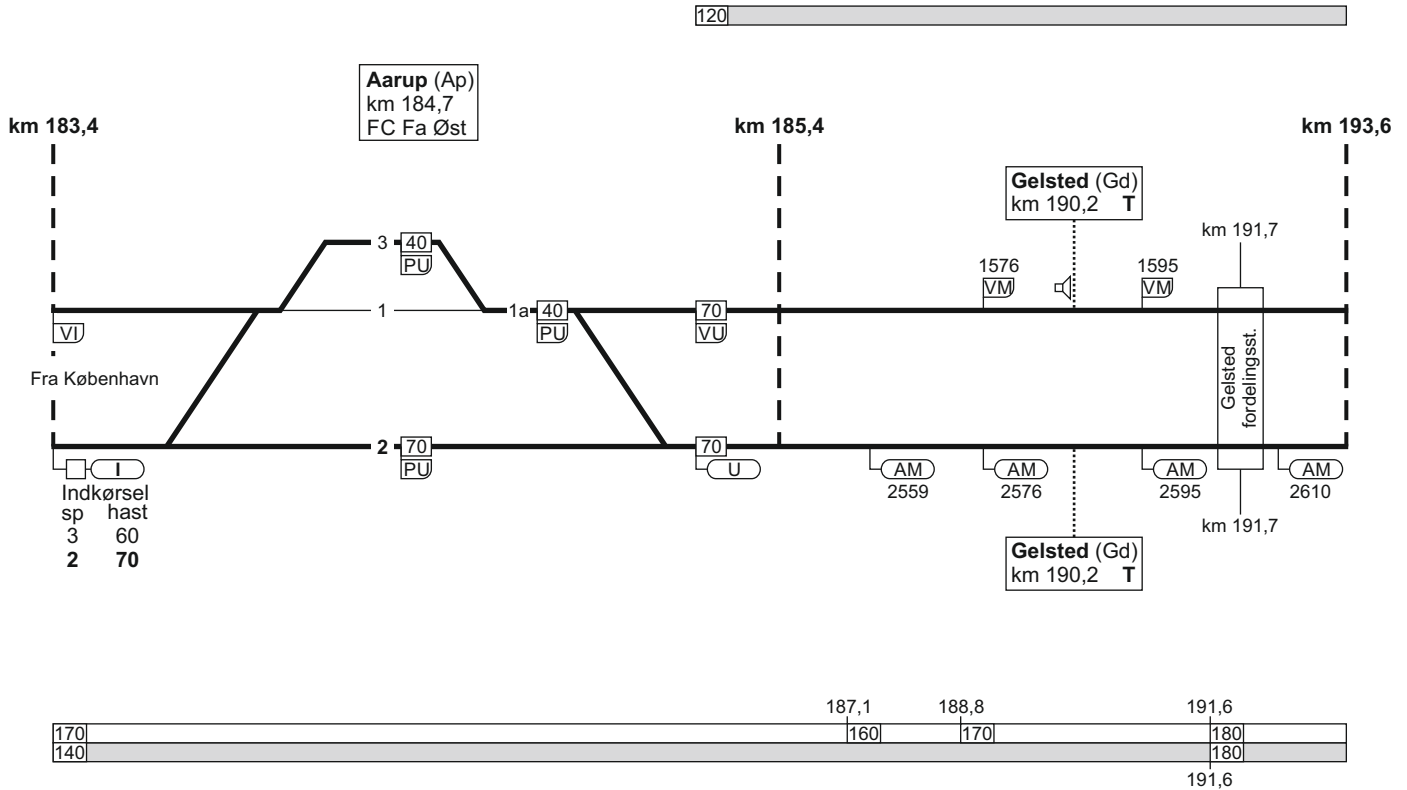

FC Fa Øst
linjeblok
stigning L

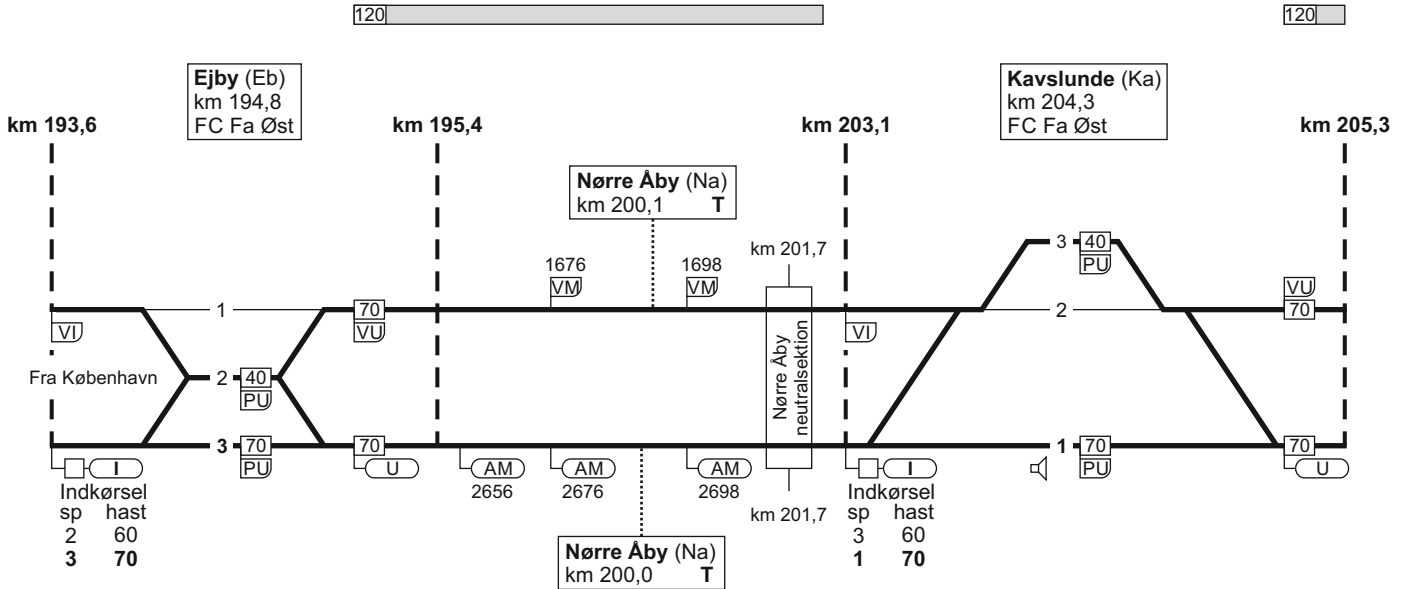

FC Fa Øst
linjeblok
stigning G

FC Fa Øst
linjeblok
stigning G

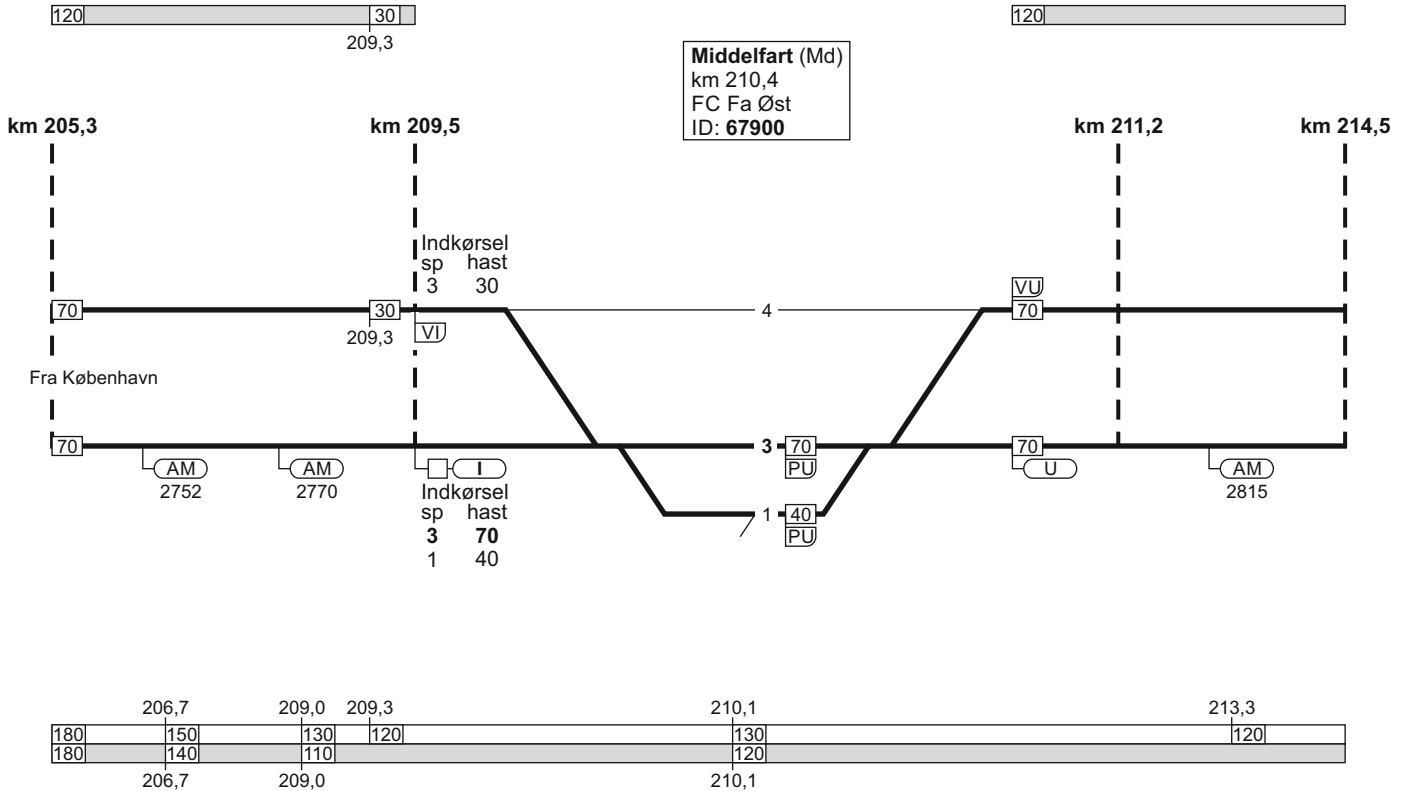

FC Fa Øst
linjeblok
stigning G

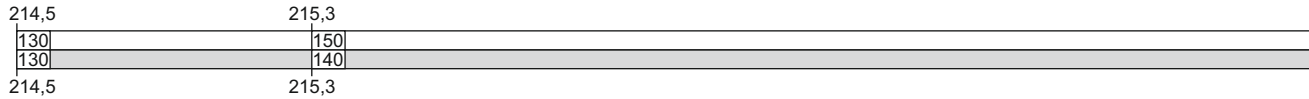
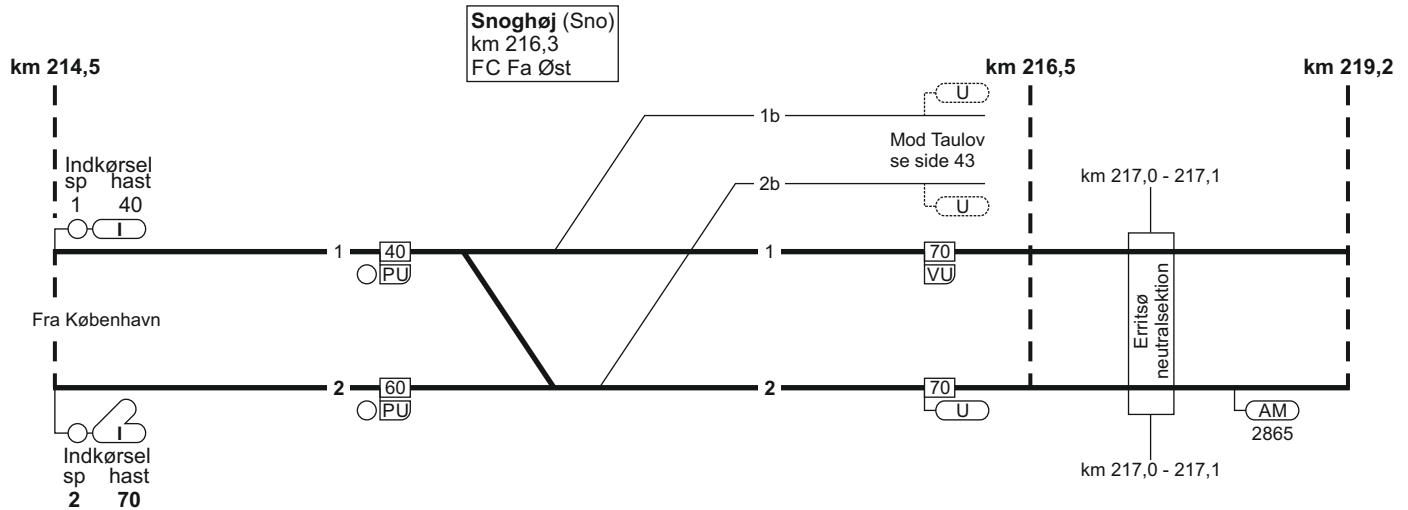

Fredericia (Fa)
 km 220,6
 overgangsstation
 ID: 62000

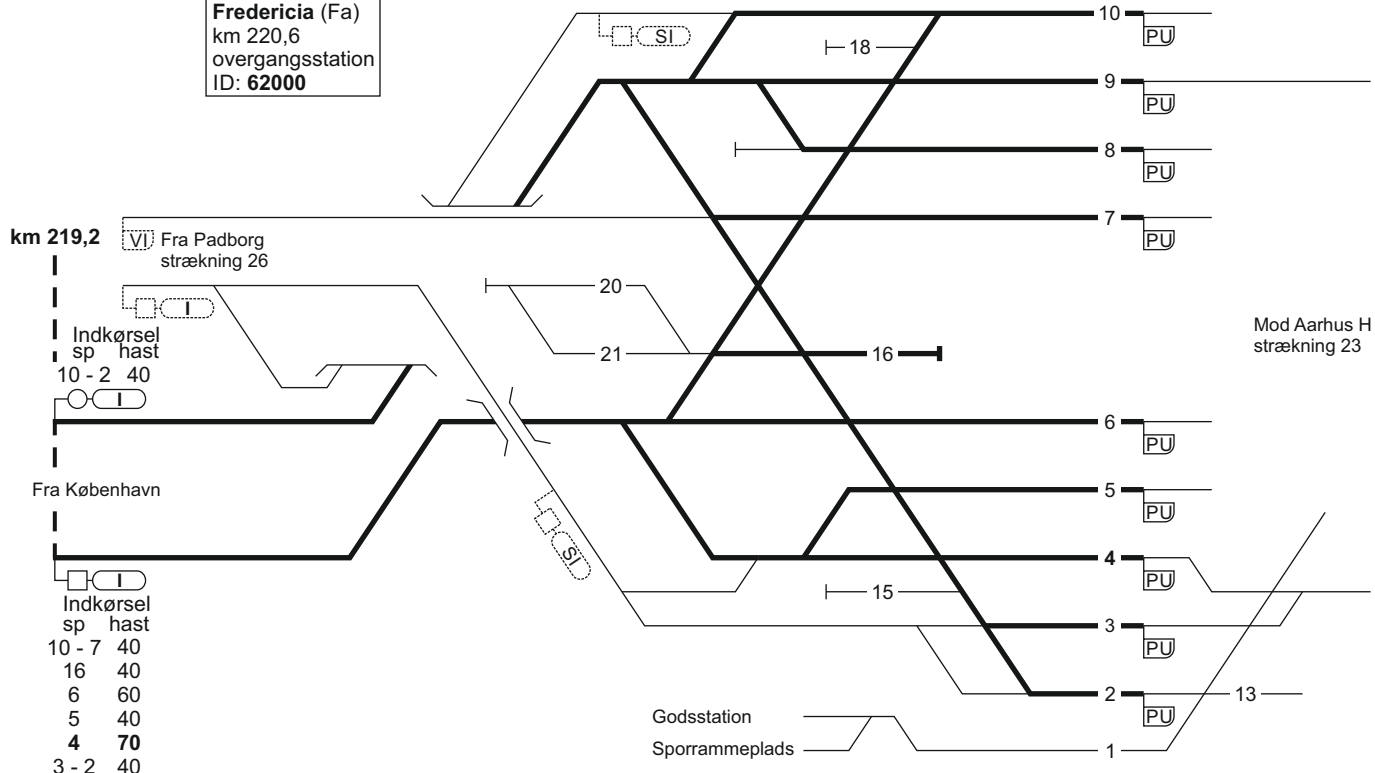

	219,4		219,9
150	130		100
140	100		
	219,4		

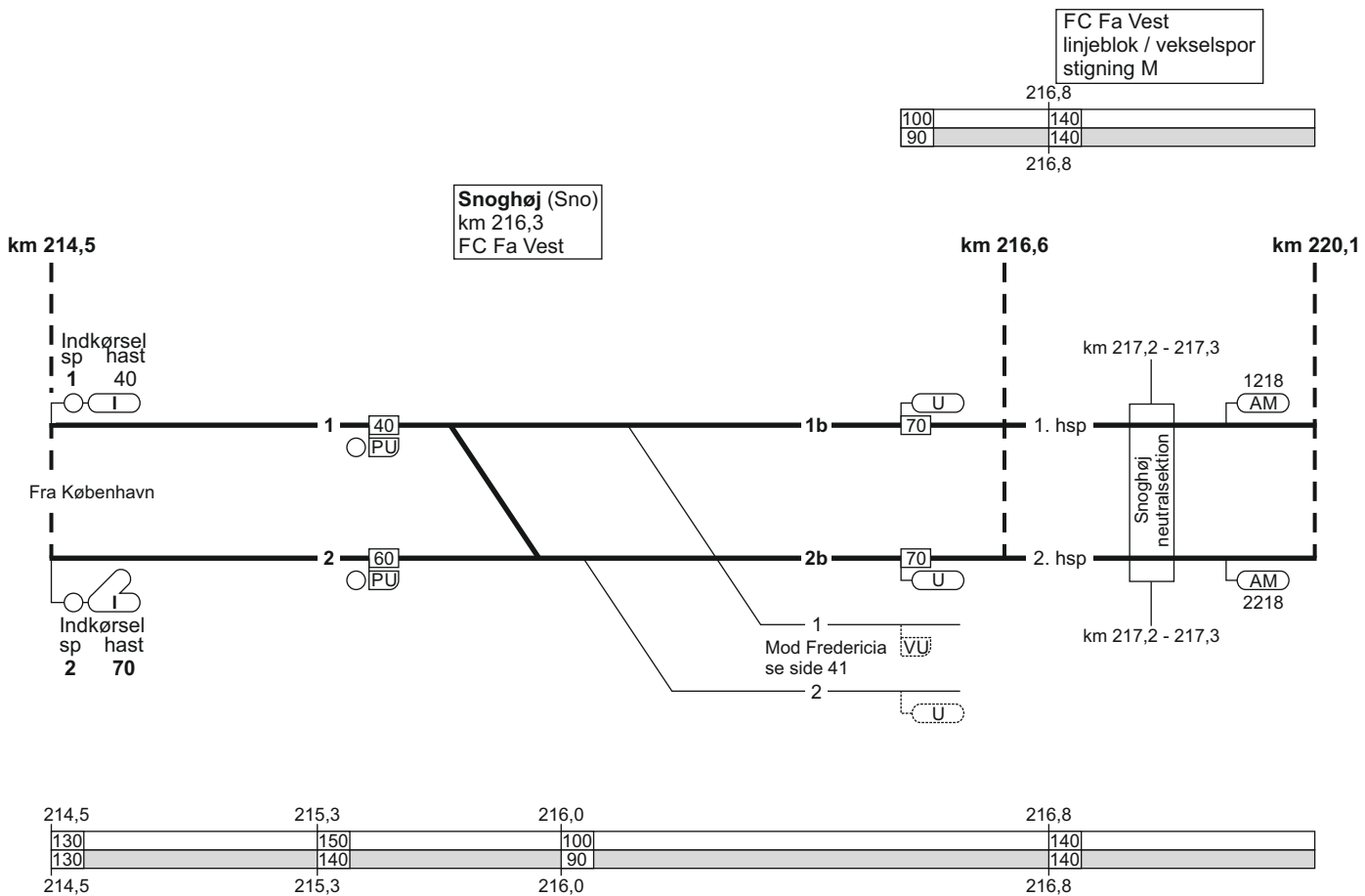

Taulov (TI)
 km 222,5
 overgangsstation
 FC Fa
 ID: 66900

120

km 220,1

km 223,6

Indkørsel
 sp hast
 4 40
 3a 70



Indkørsel
 sp hast
 4 40
 3a 70
 1a 70



Fra Fredericia
 strækning 26



Gods/kombiterminal

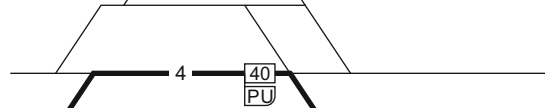

4



Indkørsel
 sp hast
 3 70
 2 60

3a



Indkørsel
 sp hast
 2 60
 1 70

1a



3

2

1



3

2

1

Mod Padborg
 strækning 26

223,4

140
 140

150

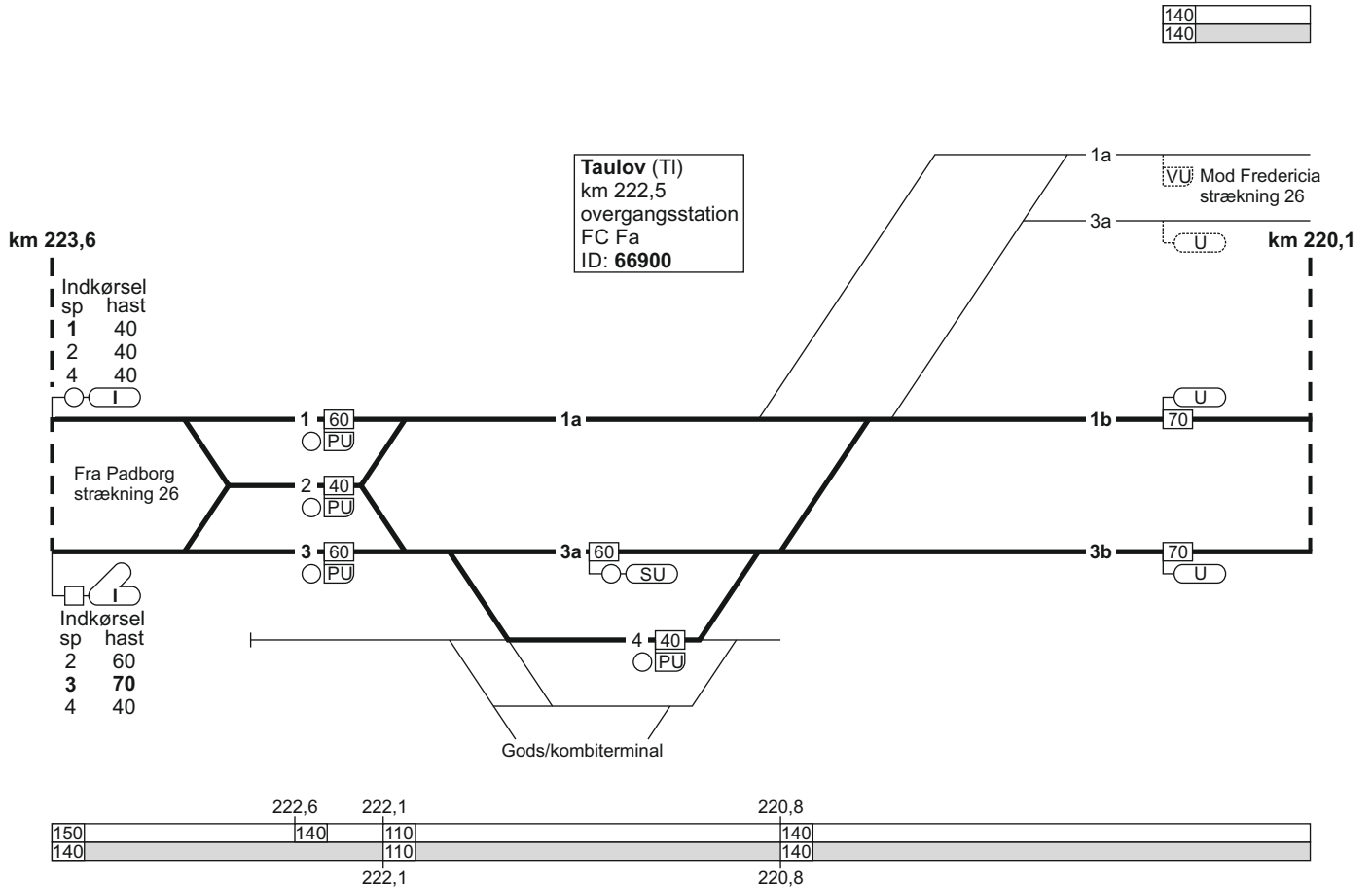

FC Fa Vest
linjeblok / vekselspor
stigning M

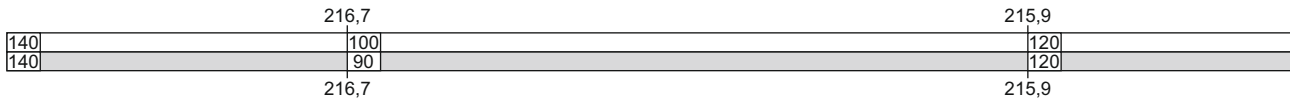
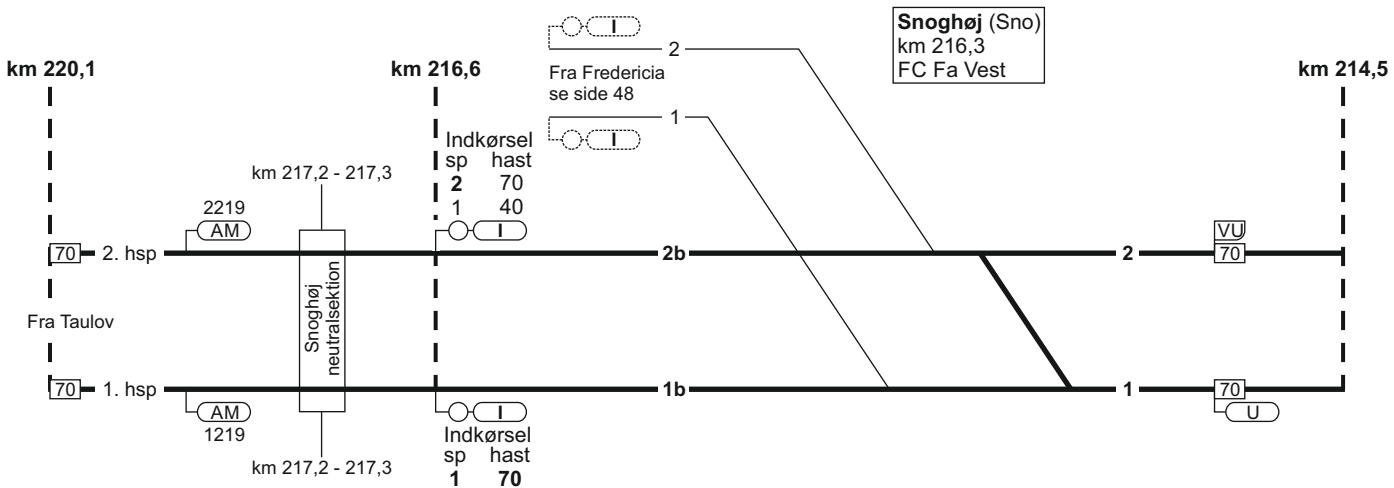
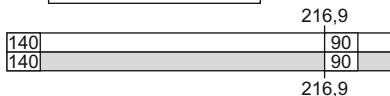

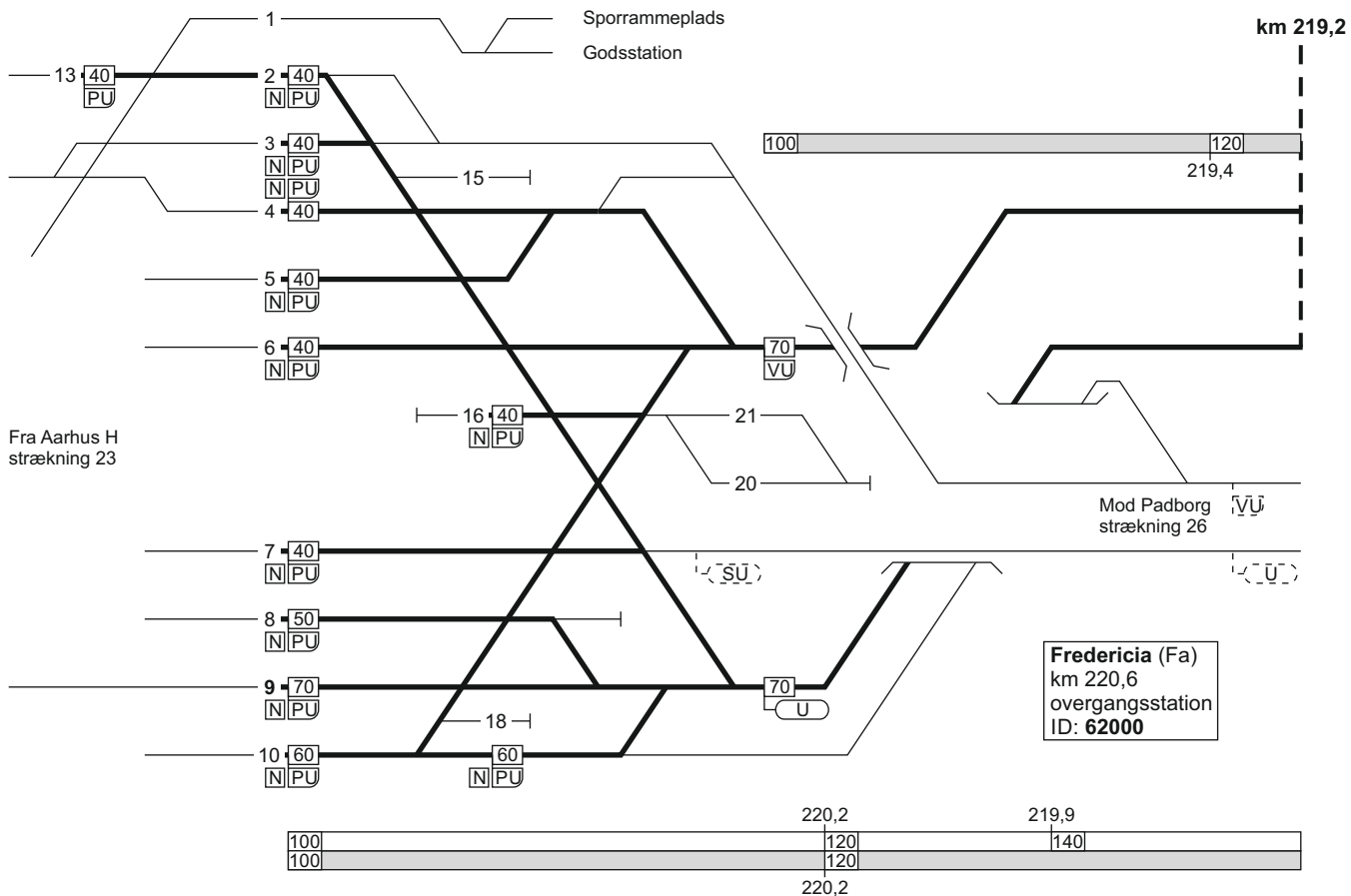

FC Fa Øst
linjeblok
stigning G

Snoghøj (Sno)
km 216,3
FC Fa Øst

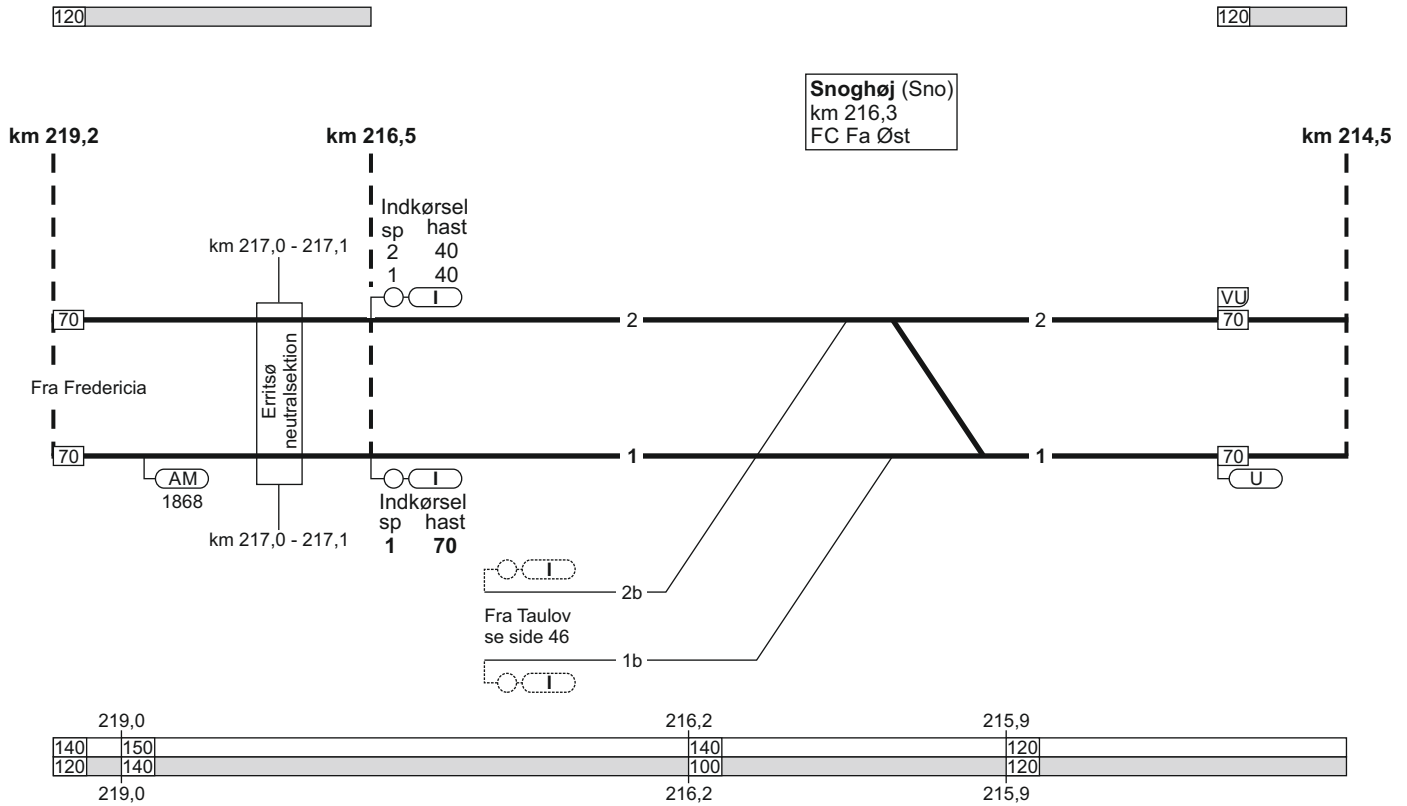

FC Fa Øst
linjeblok
stigning G

FC Fa Øst
linjeblok
stigning G



Middelfart (Md)
km 210,4
FC Fa Øst
ID: 67900

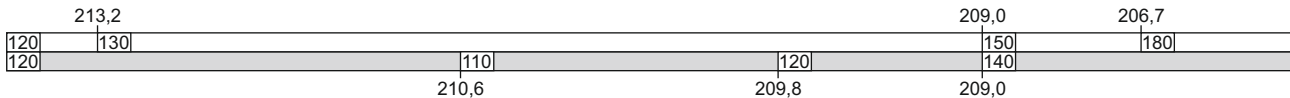
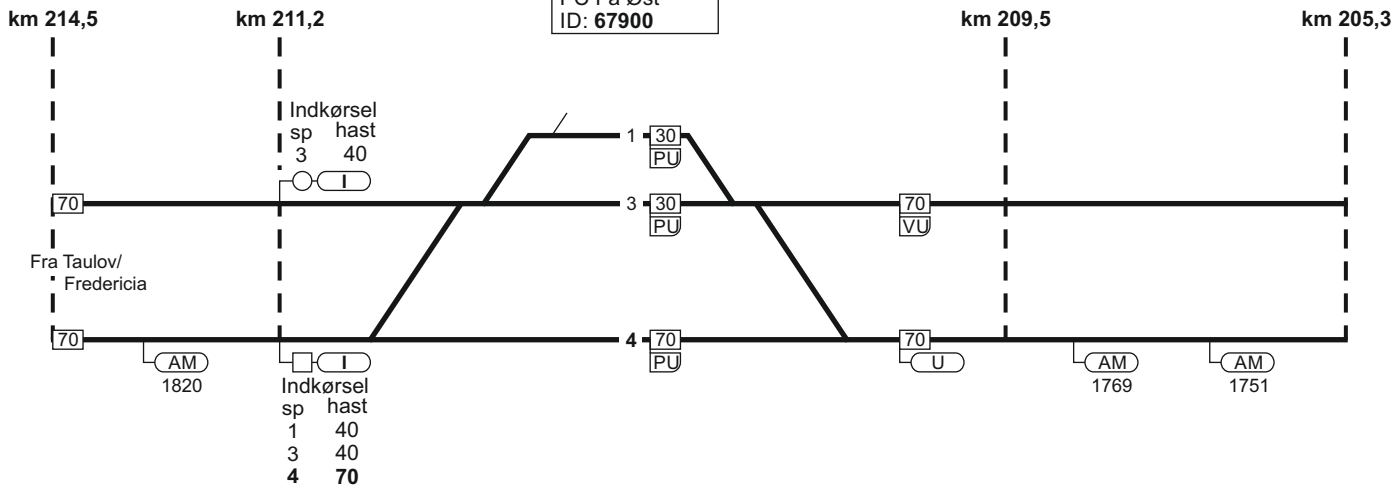

FC Fa Øst
linjeblok
stigning H

120

120

Kavslunde (Ka)
km 204,3
FC Fa Øst

Ejby (Eb)
km 194,8
FC Fa Øst

km 205,3

km 203,1

km 195,4

km 193,6

Indkørsel
sp hast
3 40

Fra Taulov/
Fredericia

Indkørsel
sp hast
2 70
3 40

Nørre Åby (Na)
km 200,0
T

km 201,8
2700
VM

2678
VM

km 201,8

Nørre Åby (Na)
km 200,1
T

1700
AM

1678
AM

1658
AM

Indkørsel
sp hast
2 60
1 70

180
140

180

204,4

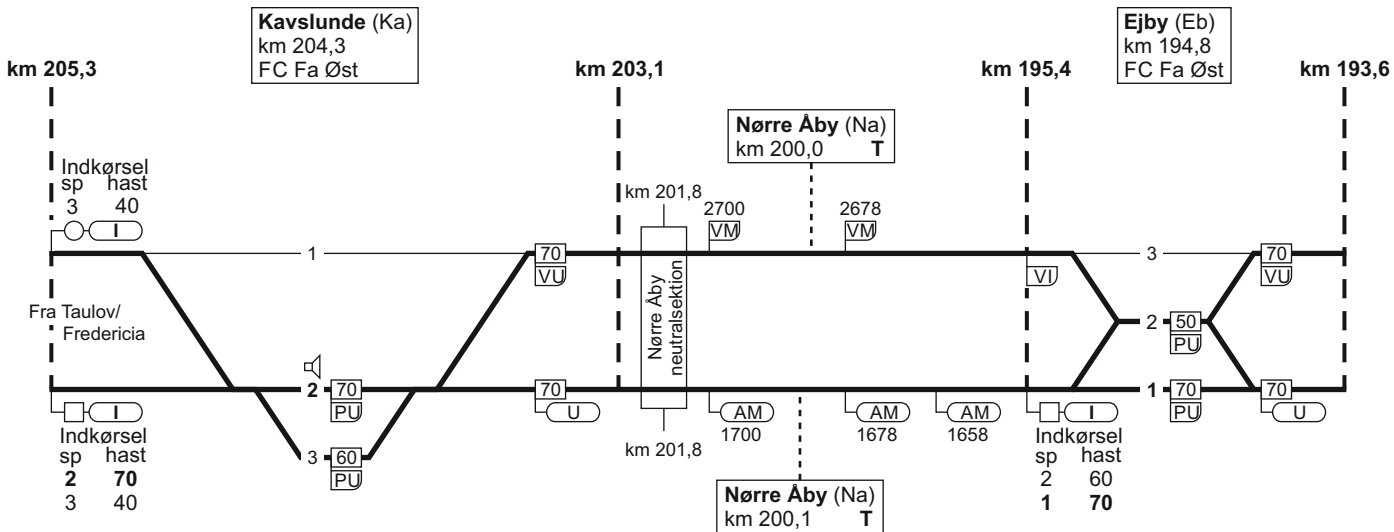

FC Fa Øst
linjeblok
stigning G

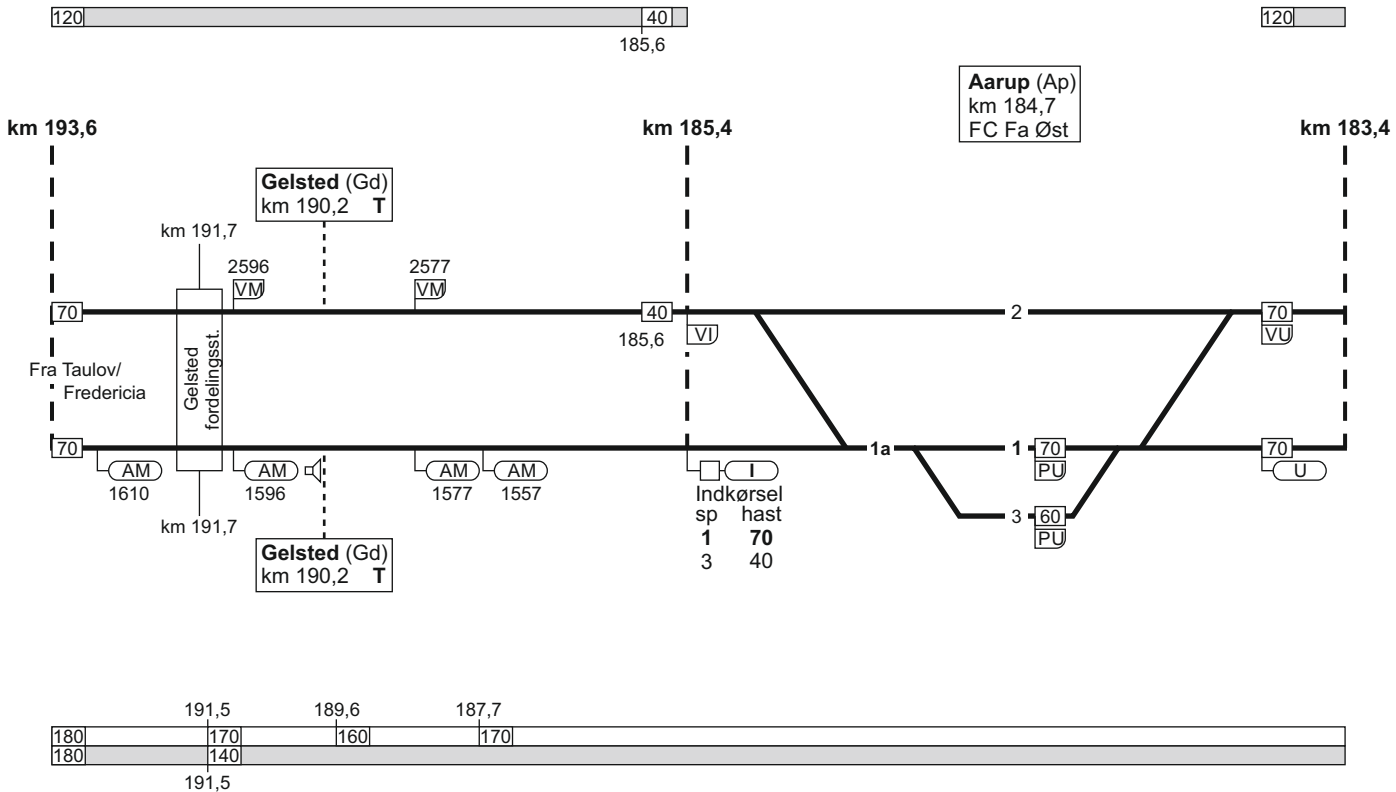

FC Fa Øst
linjeblok
stigning K

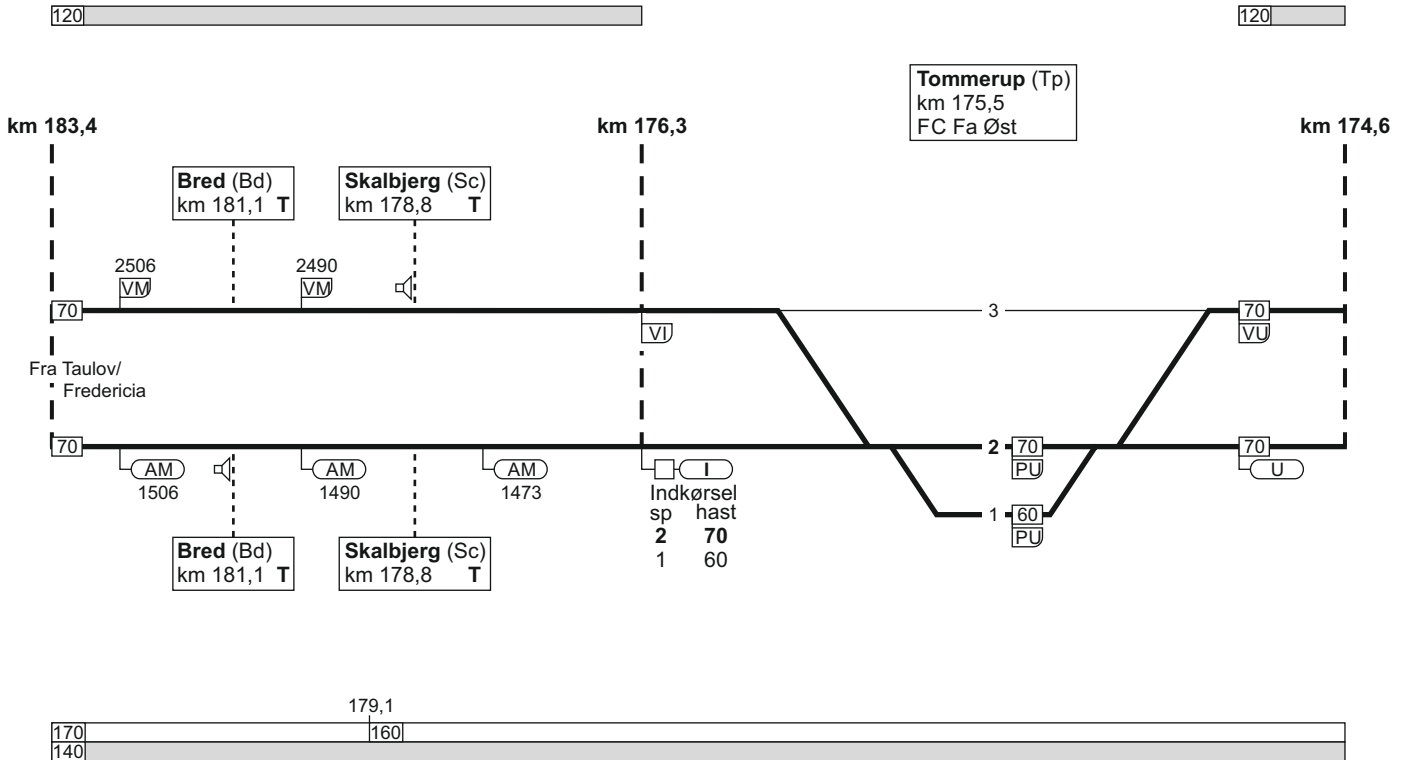

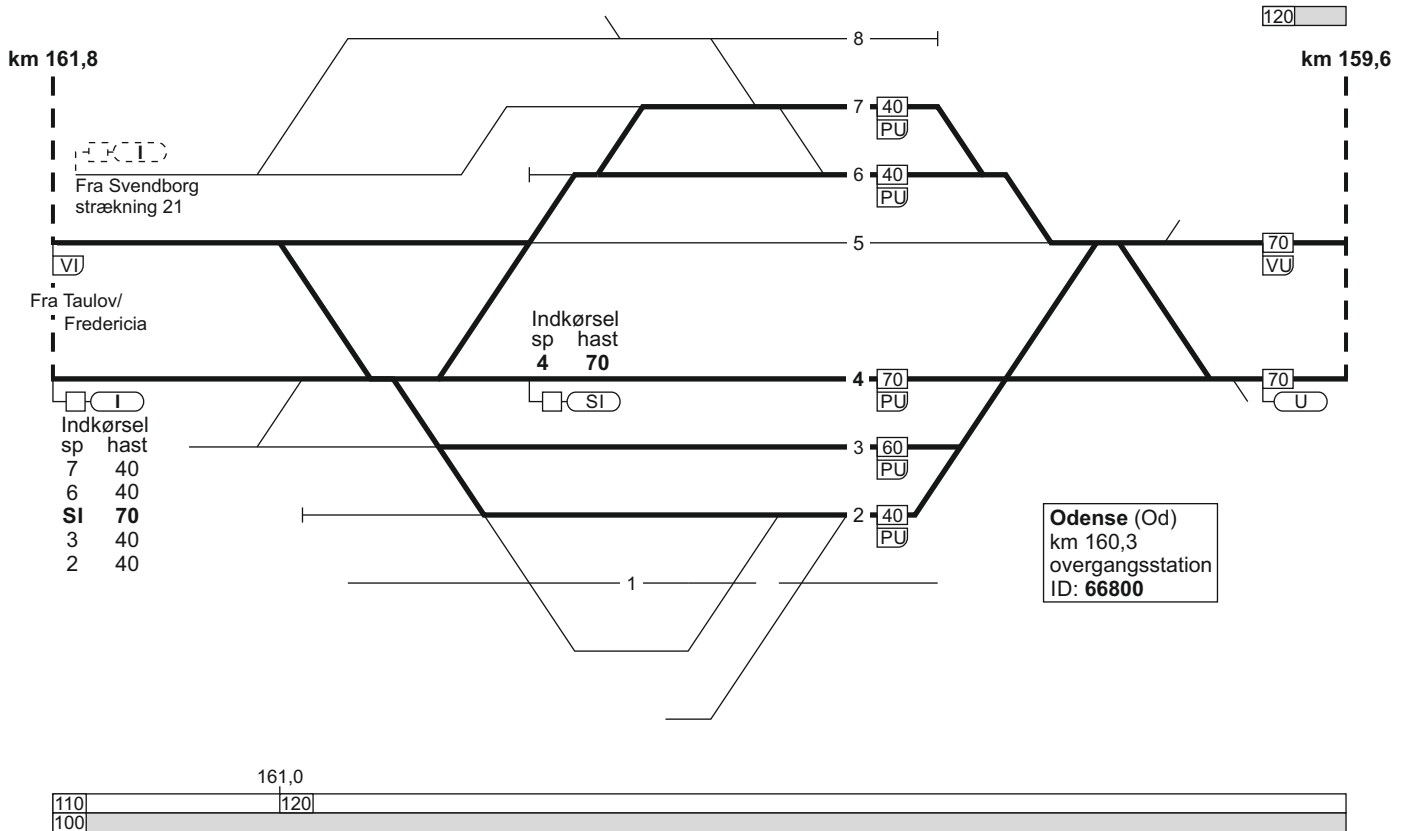

FC Ro Vest
linjeblok
stigning J

FC Ro Vest
linjeblok
stigning L

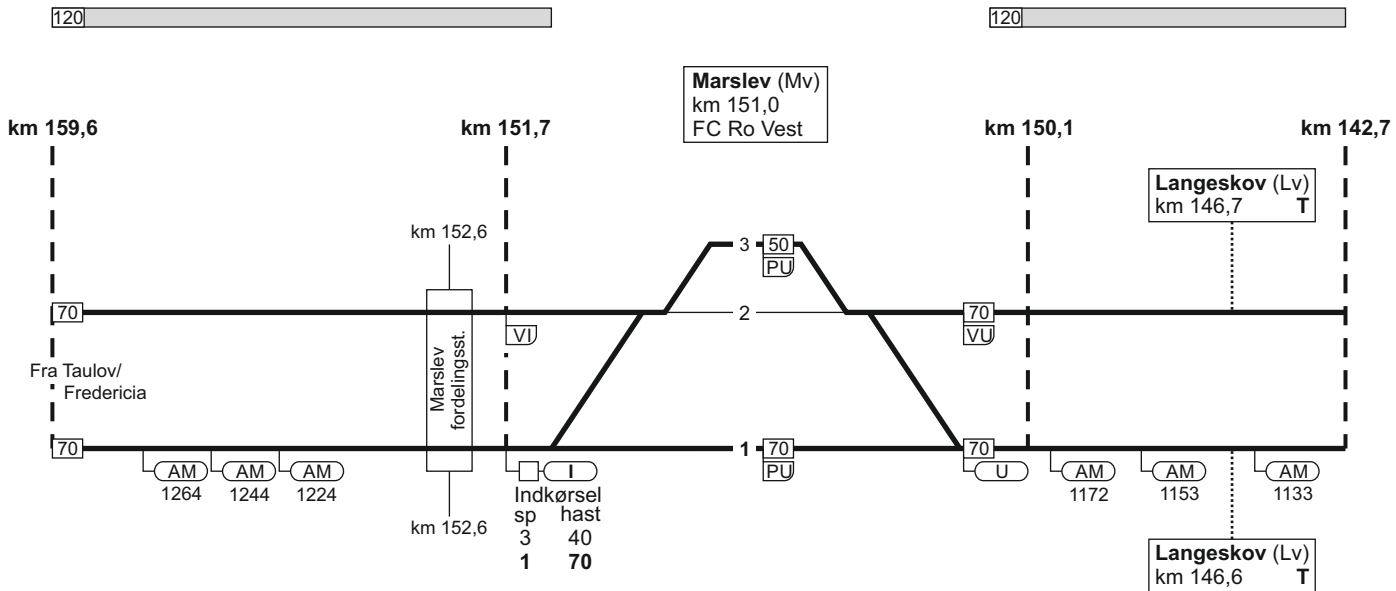

159,6



159,6 158,4

FC Ro Vest
linjeblok
stigning M

FC Ro Vest
linjeblok
stigning J

120

120

Ullerslev (Uv)
km 141,5
FC Ro Vest

Hjulby (Ju)
km 136,6
FC Ro Vest

km 142,7

km 141,0

km 137,2

km 135,6

km 133,0

Fra Taulov/
Fredericia

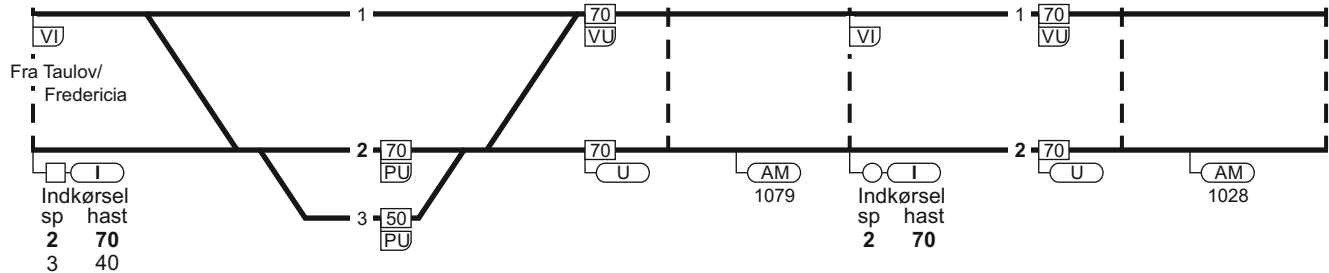

180
180

FC Ro Vest
linjeblok / vekselspor
stigning F

180
180

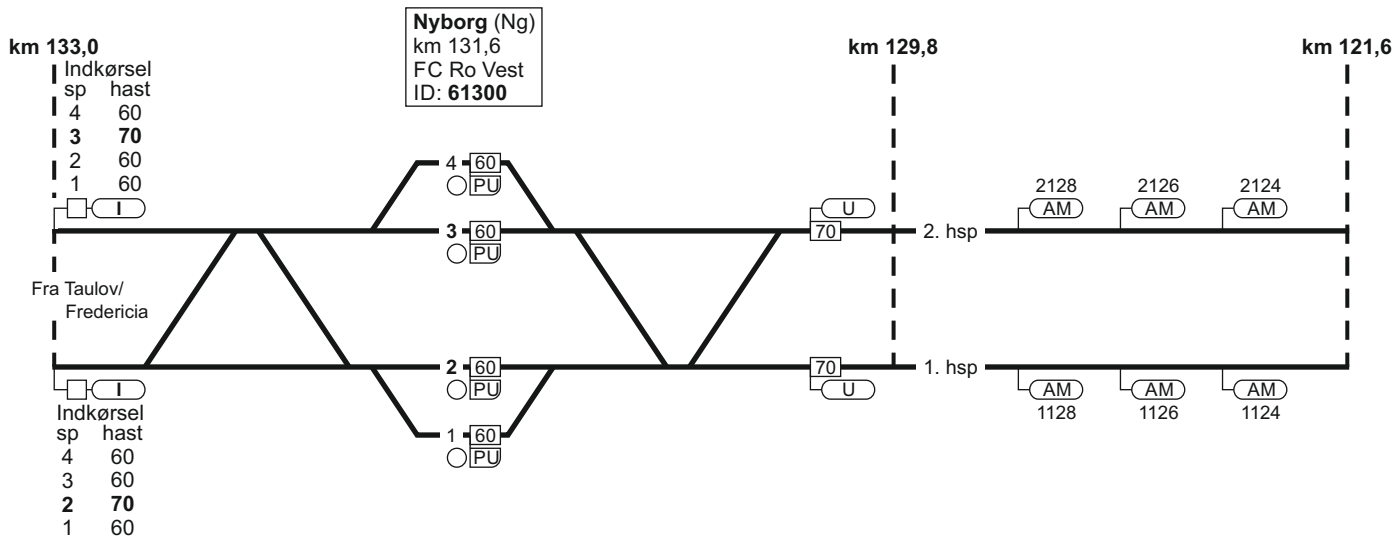

180
180

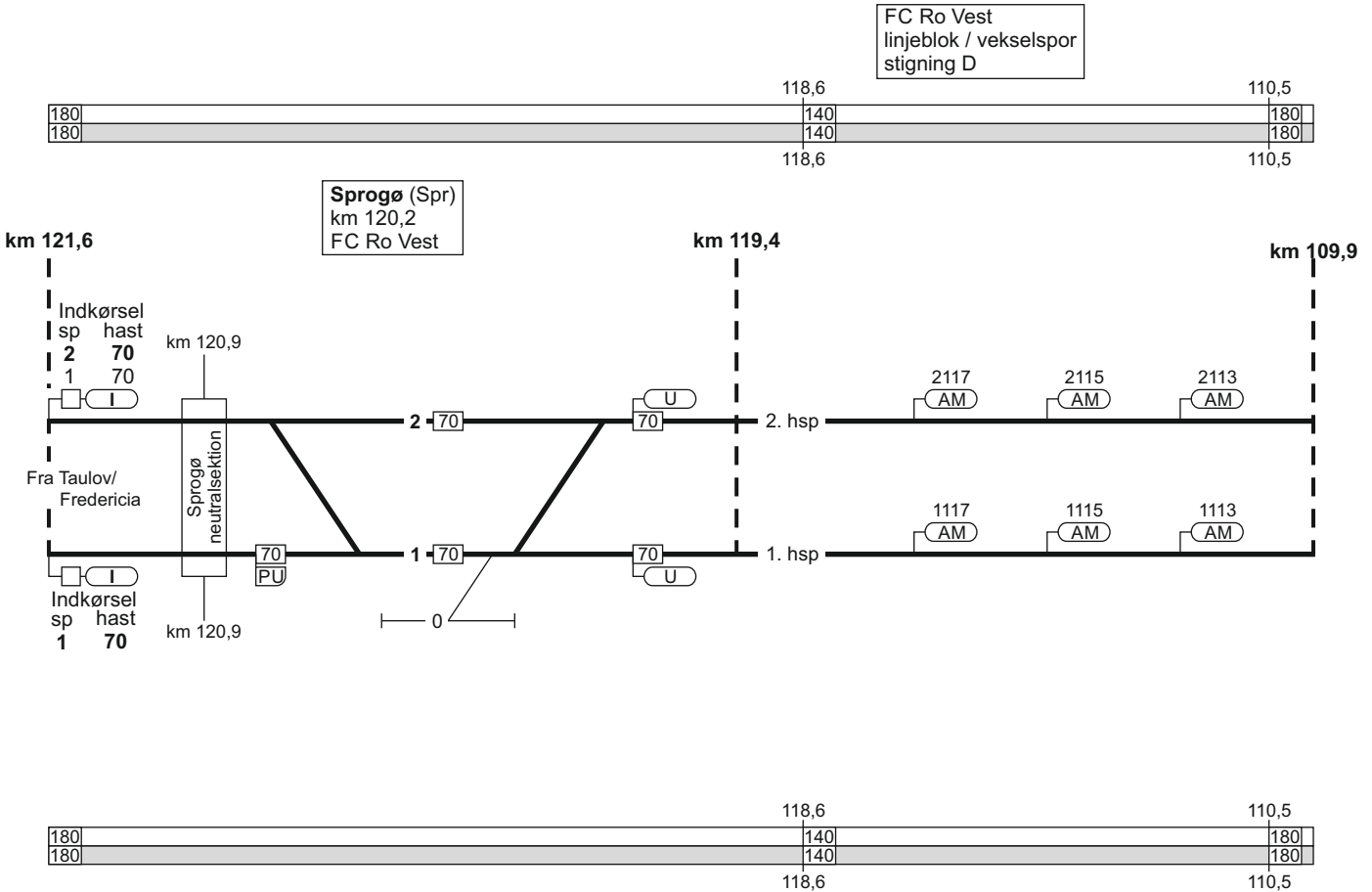

Korsør (Kø)
 km 108,3
 FC Ro Vest
 ID: 61200

120

km 109,9

km 107,2

Indkørsel	sp	hast
4	60	
3	70	
2	60	
1	60	

Fra Taulov/
Fredericia

Indkørsel	sp	hast
4	60	
3	60	
2	70	
1	60	

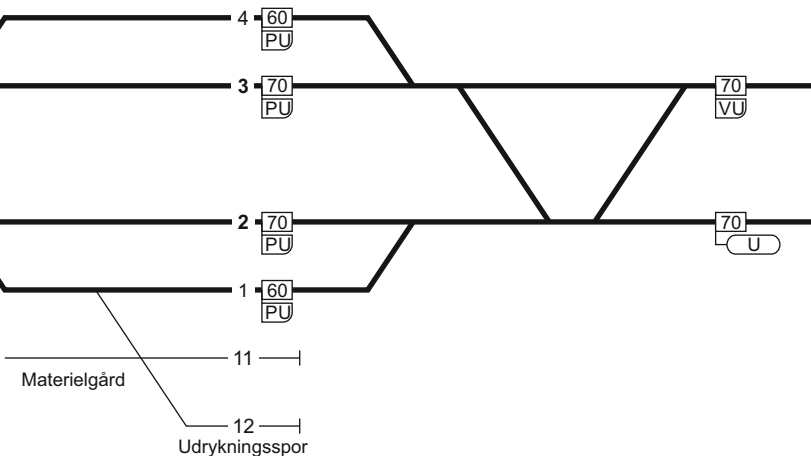

180
180

FC Ro Vest
linjeblok
stigning L

FC Ro Vest
linjeblok
stigning L

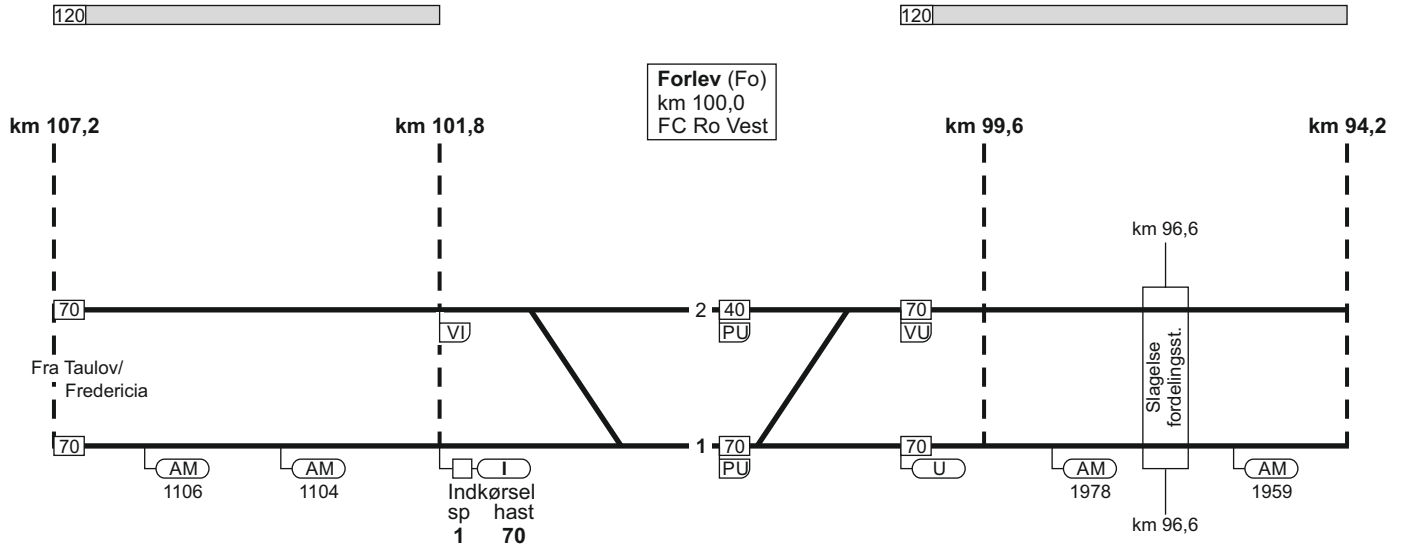

Forlev (Fo)
km 100,0
FC Ro Vest

FC Ro Vest
linjeblok
stigning L

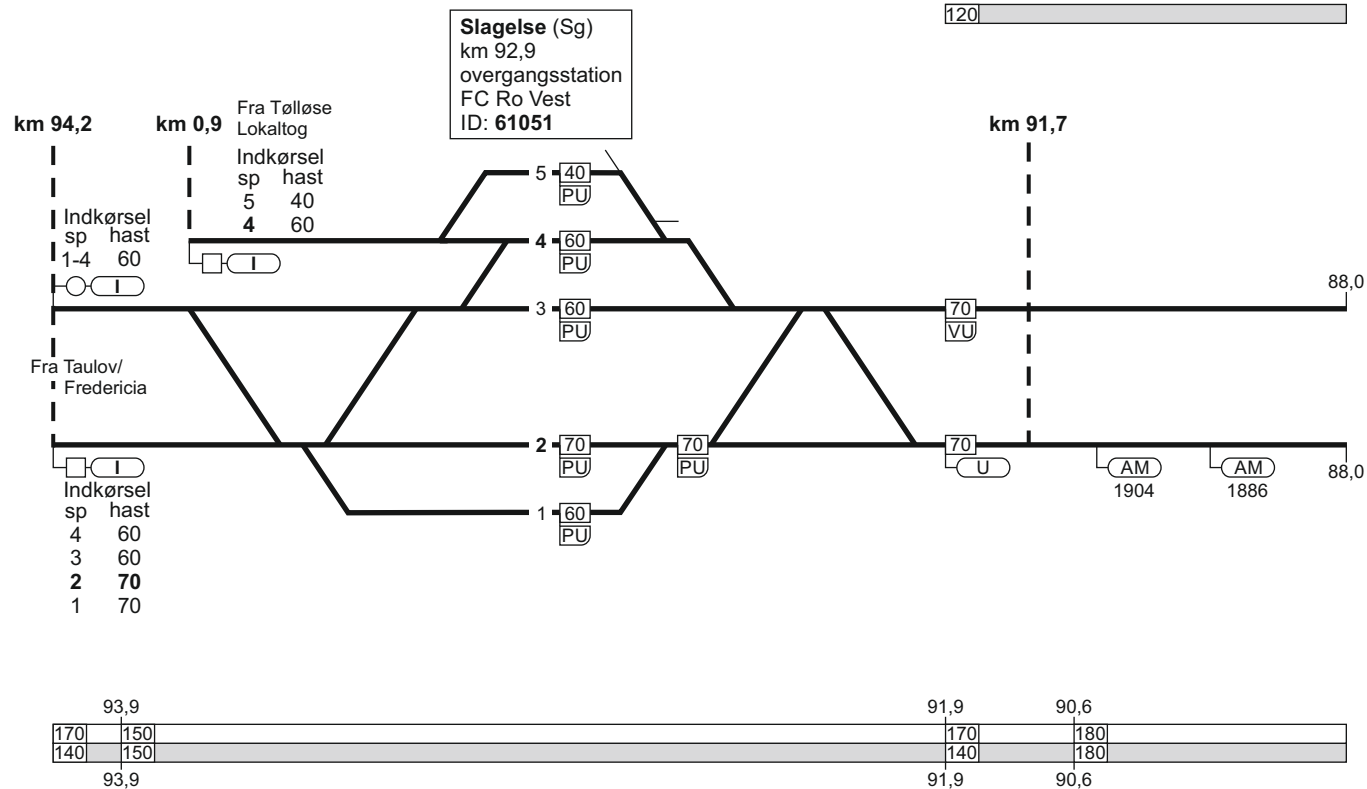

FC Ro Vest
linjeblok
stigning L

Sorø (So)
km 78,3
FC Ro Vest

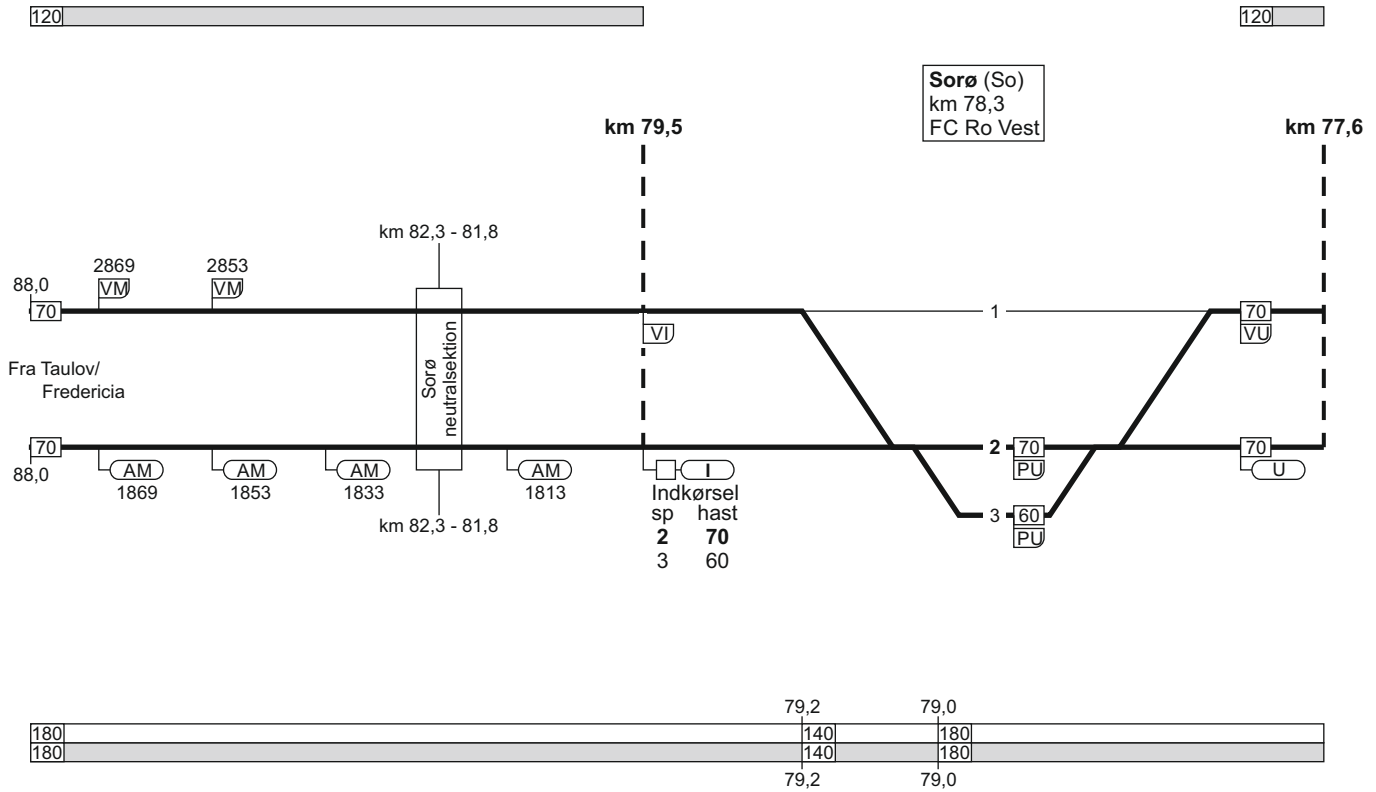

FC Ro Vest
linjeblok
stigning M

FC Ro Vest
linjeblok
stigning L

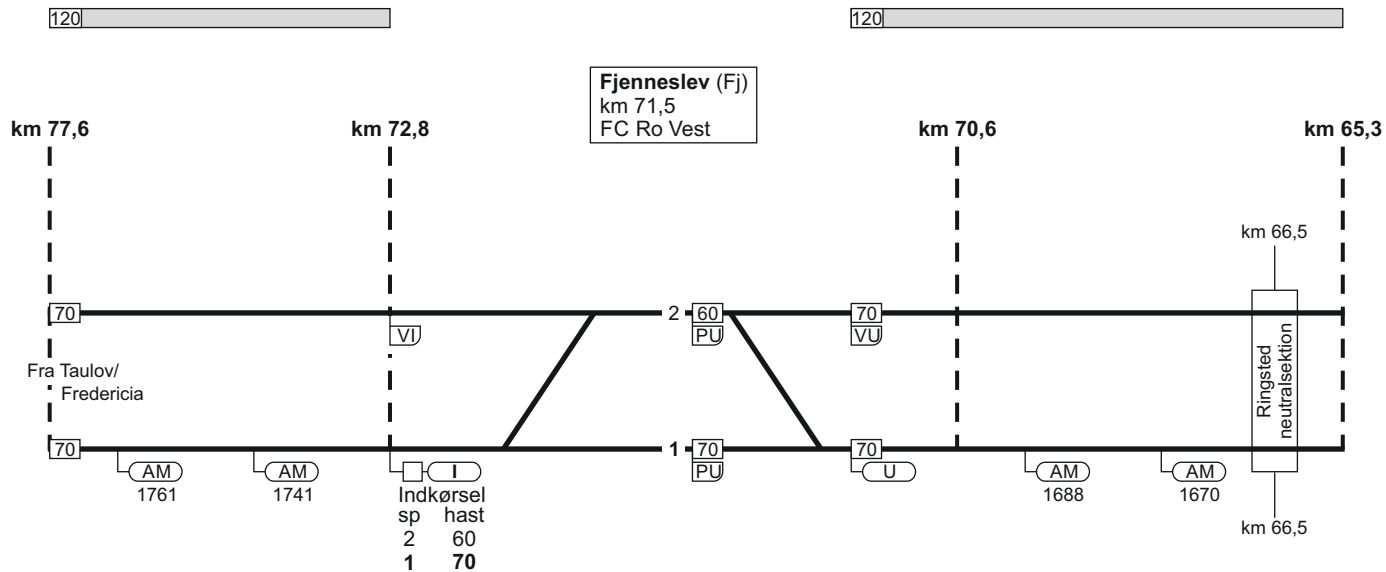

km 65,3

Indkørsel
sp hast

1 - 6 40



Ringsted (Rg)
km 63,9
overgangsstation
FC Ro Midt
ID: 66300

Fra Taulov/Fredericia
mod København H strækning 6



Indkørsel
sp hast

2 70
3 40
4 40
5 40
6 40



Fra Lundby
strækning 2



64,9



64,9

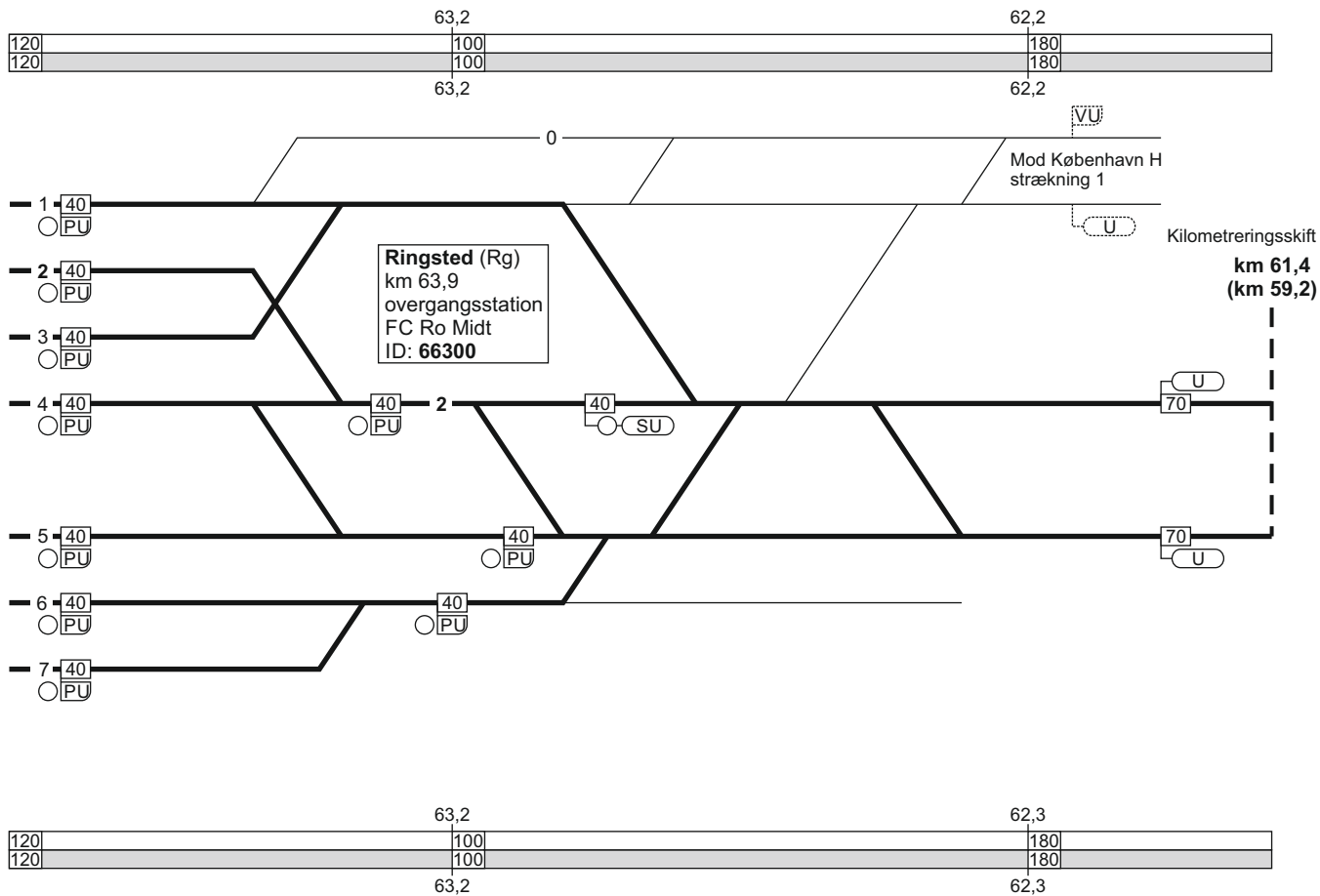

km 65,3

Indkørsel
sp hast
1 - 6 40



Ringsted (Rg)
km 63,9
overgangsstation
FC Ro Midt
ID: 66300

Fra Taulov/Fredericia
mod København H strækning 1



Indkørsel
sp hast
2 70
3 40
4 40
5 40
6 40

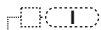

Fra Lundby
strækning 2

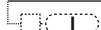

64,9



64,9

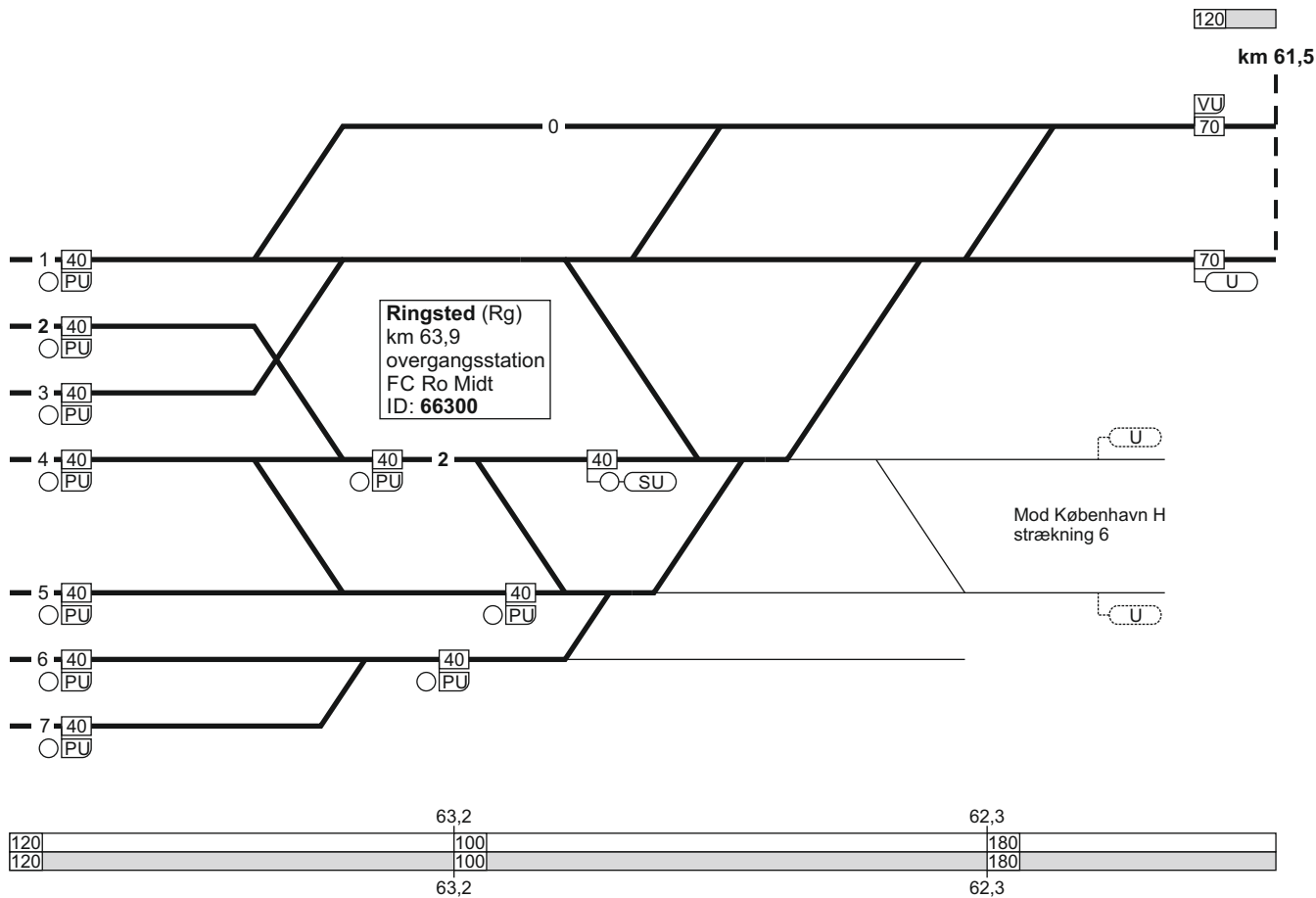

FC Ro Midt
linjeblok
stigning L

Kværkeby (Ky)
km 56,6
FC Ro Midt

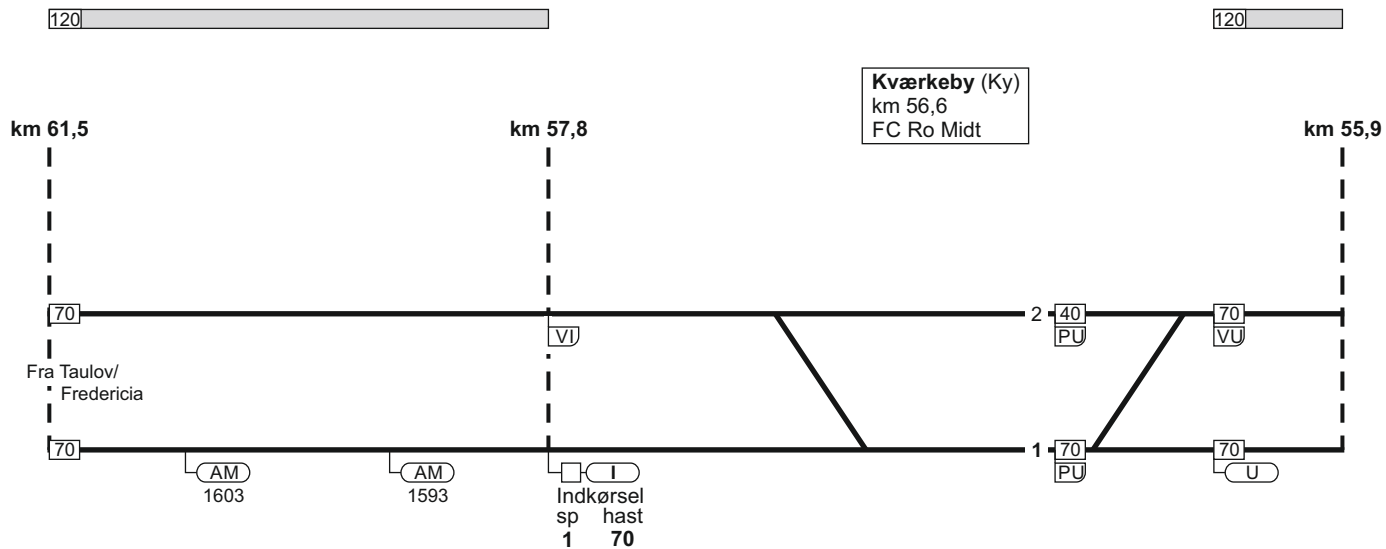

FC Ro Midt
linjeblok
stigning L

FC Ro Midt
linjeblok
stigning K

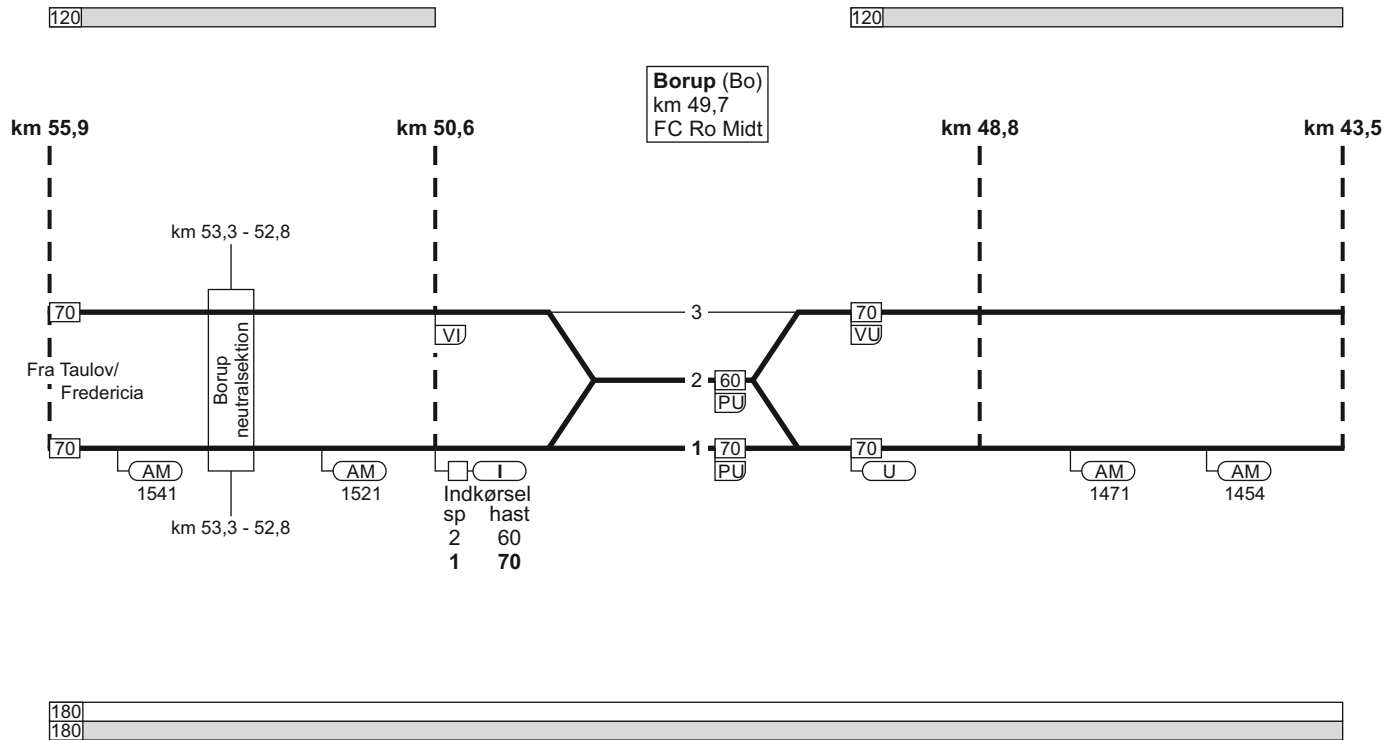

FC Ro Midt
linjeblok
stigning L

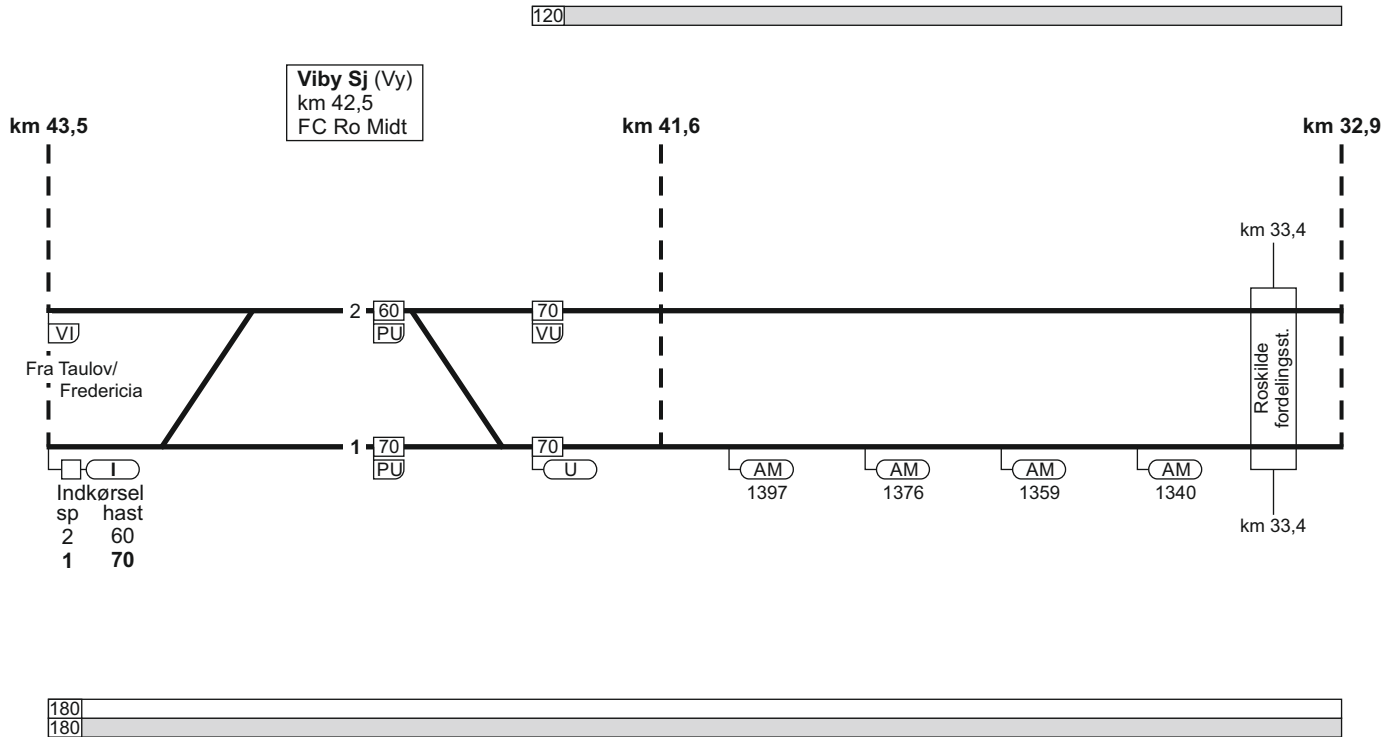

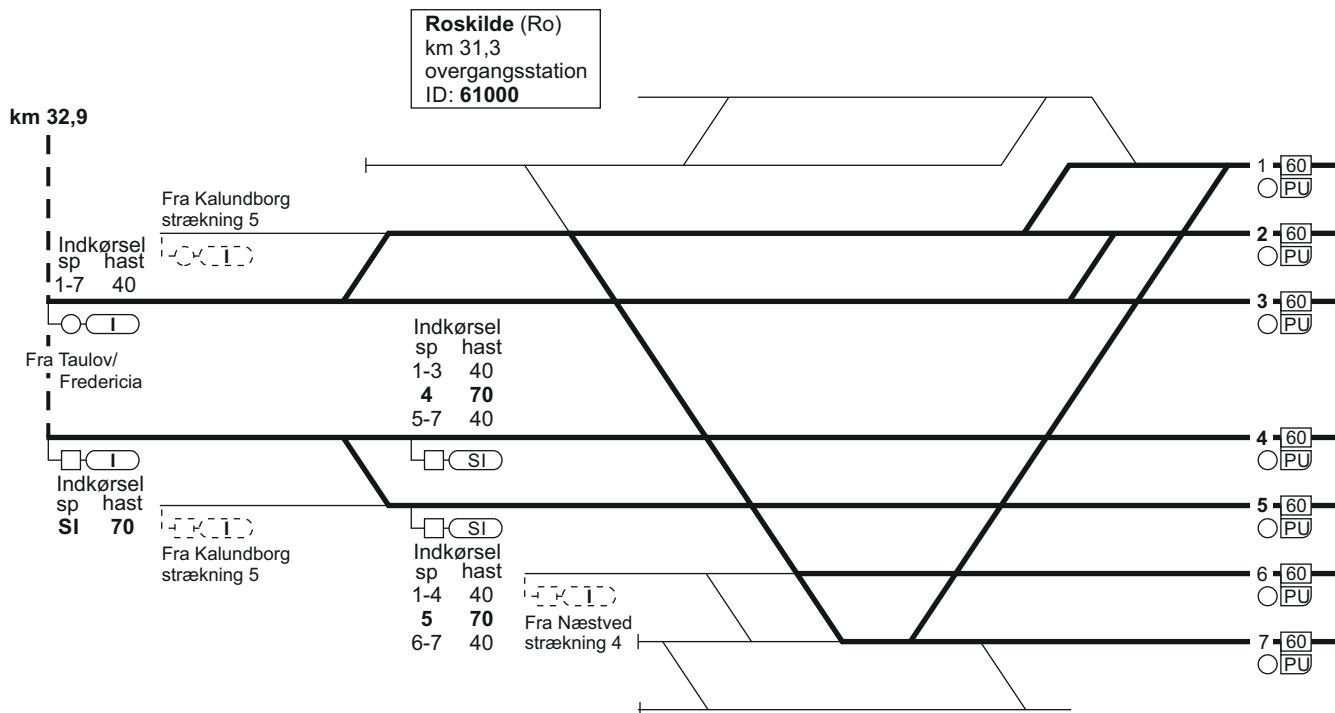

	32,3		32,0	
180	160		120	
180	140		120	
	32,3		32,0	120
80				120

31,2

Roskilde (Ro)
 km 31,3
 overgangsstation
 ID: 61000

180
180
180
180

km 30,1

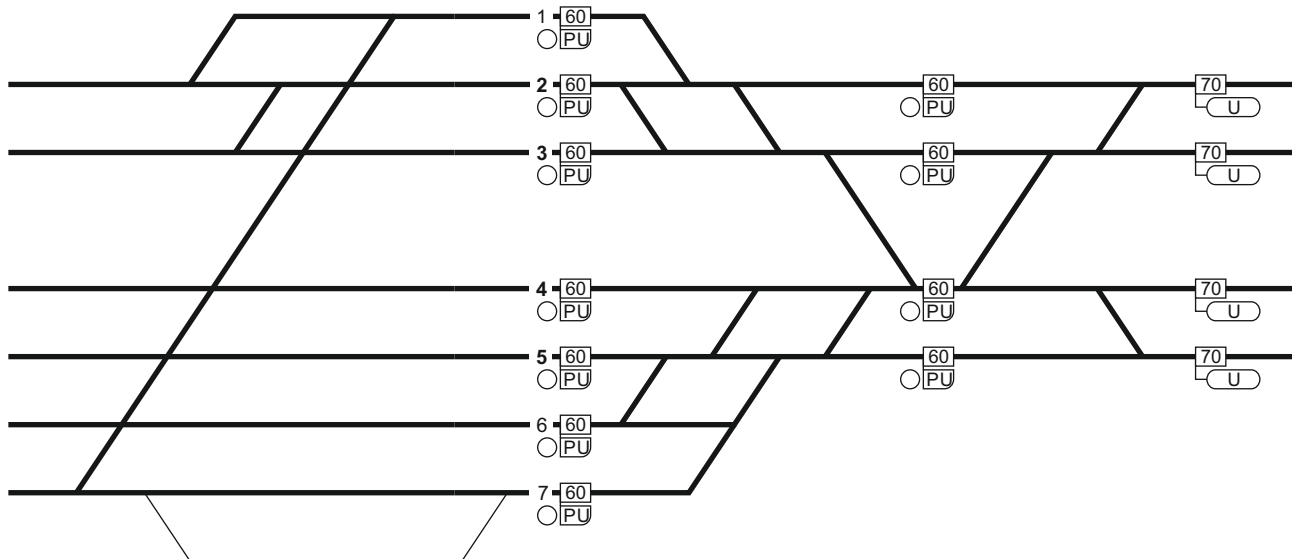

		31,1		30,6	
120		160		180	
120		140		180	
		120			180
80	120				180
	31,2			30,4	

FC Ro Øst
linjeblok / vekselspor
stigning M

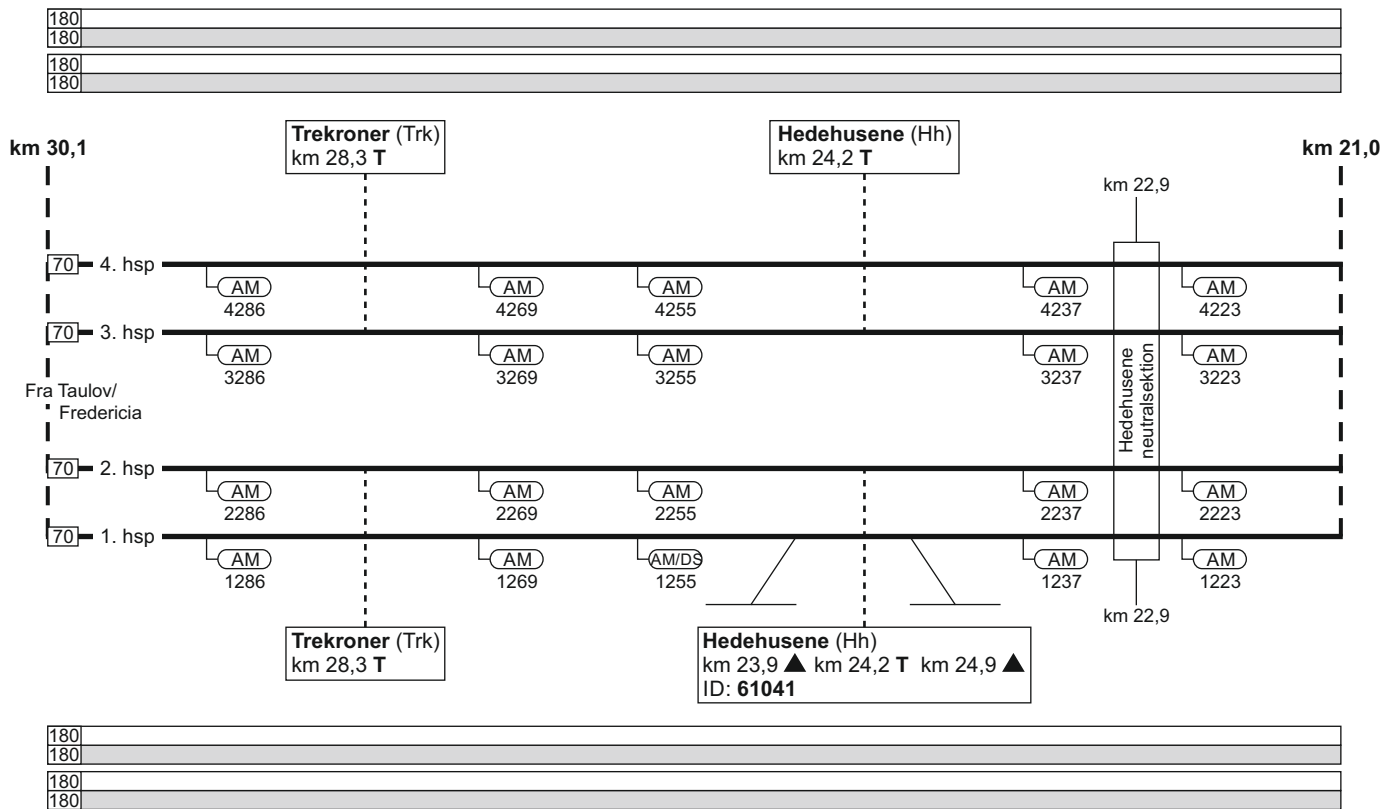

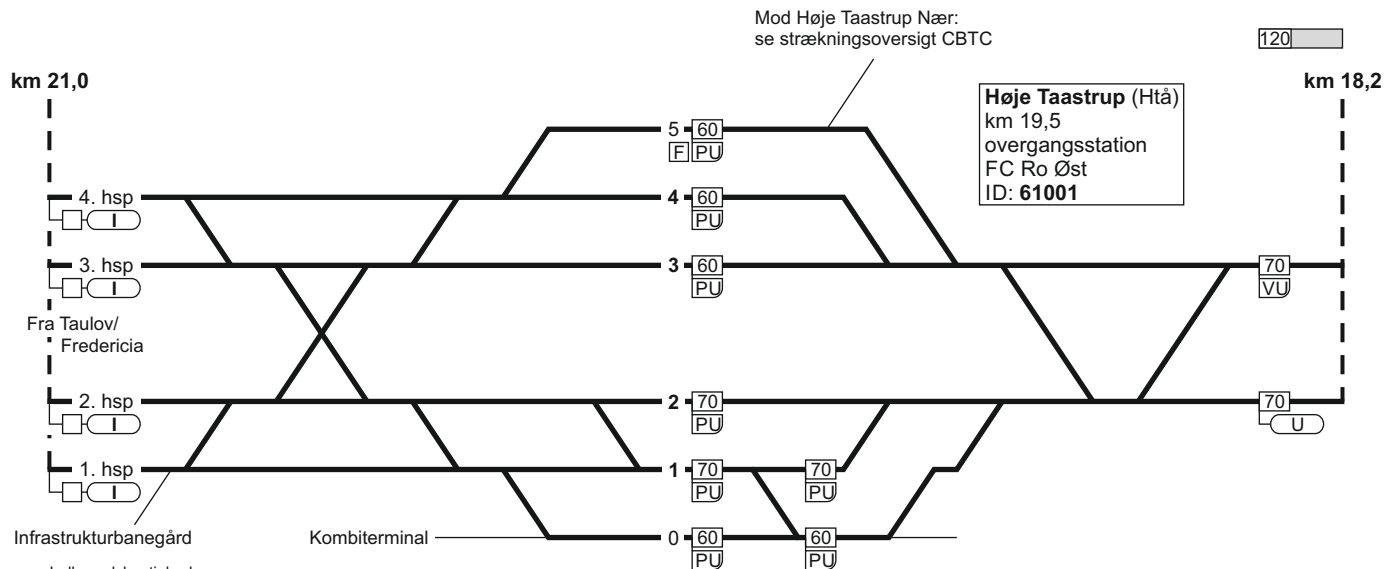

Indkørselshastigheder

Fra \ Til	5	4	3	2	1	0
4. hsp	60	70	60	60	60	60
3. hsp	60	60	70	60	60	60
2. hsp	60	60	60	70	60	60
1. hsp	60	60	60	60	70	60

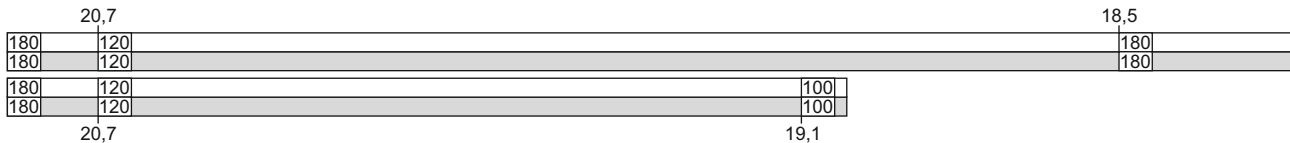

FC Glostrup
linjeblok
stigning M

FC Glostrup
linjeblok
stigning M

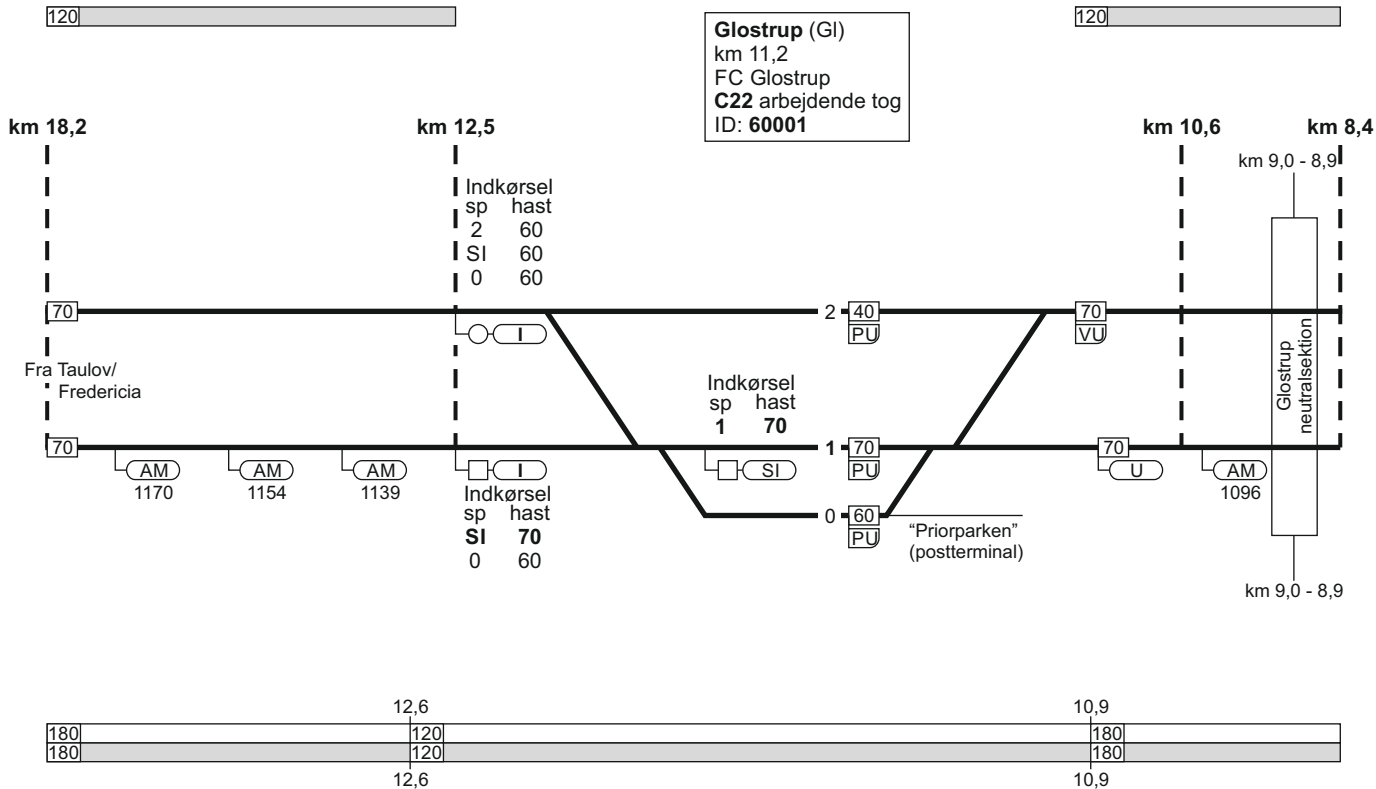

FC Glostrup
linjeblok
stigning K

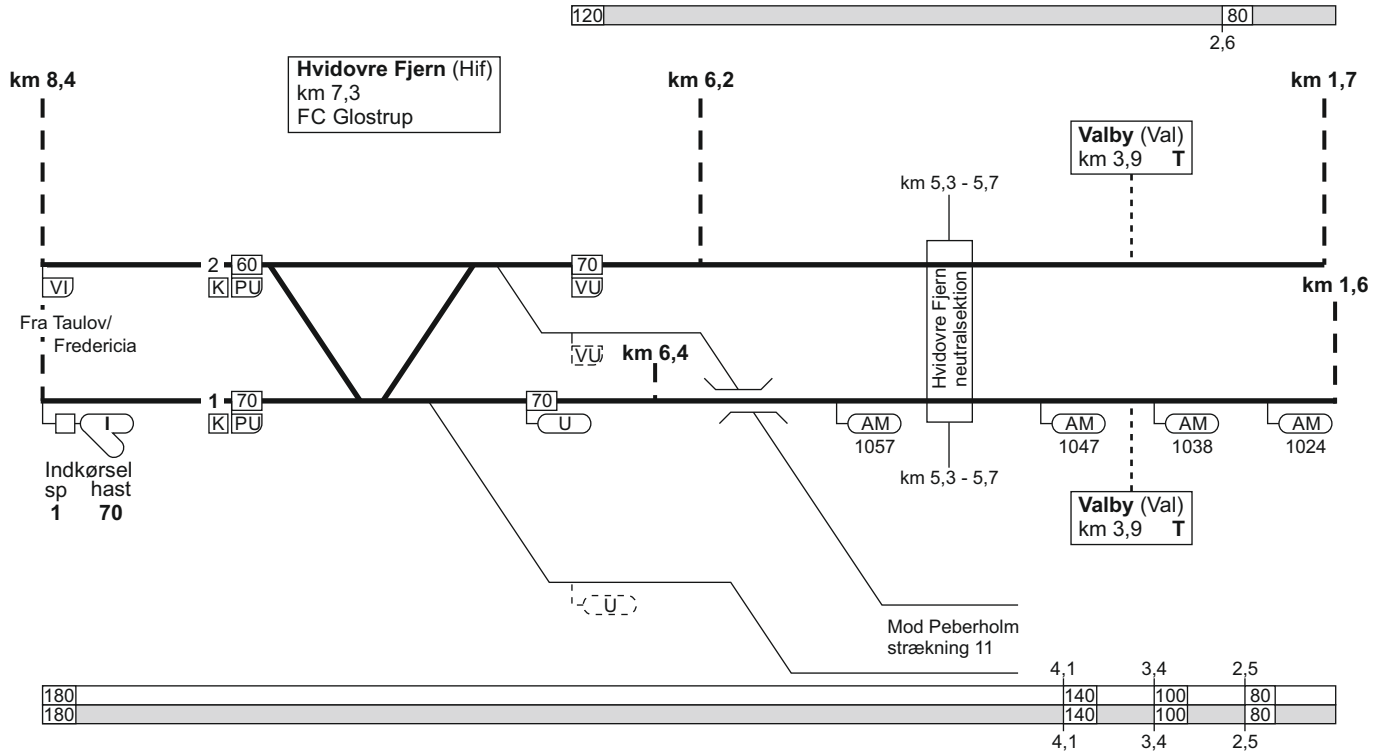

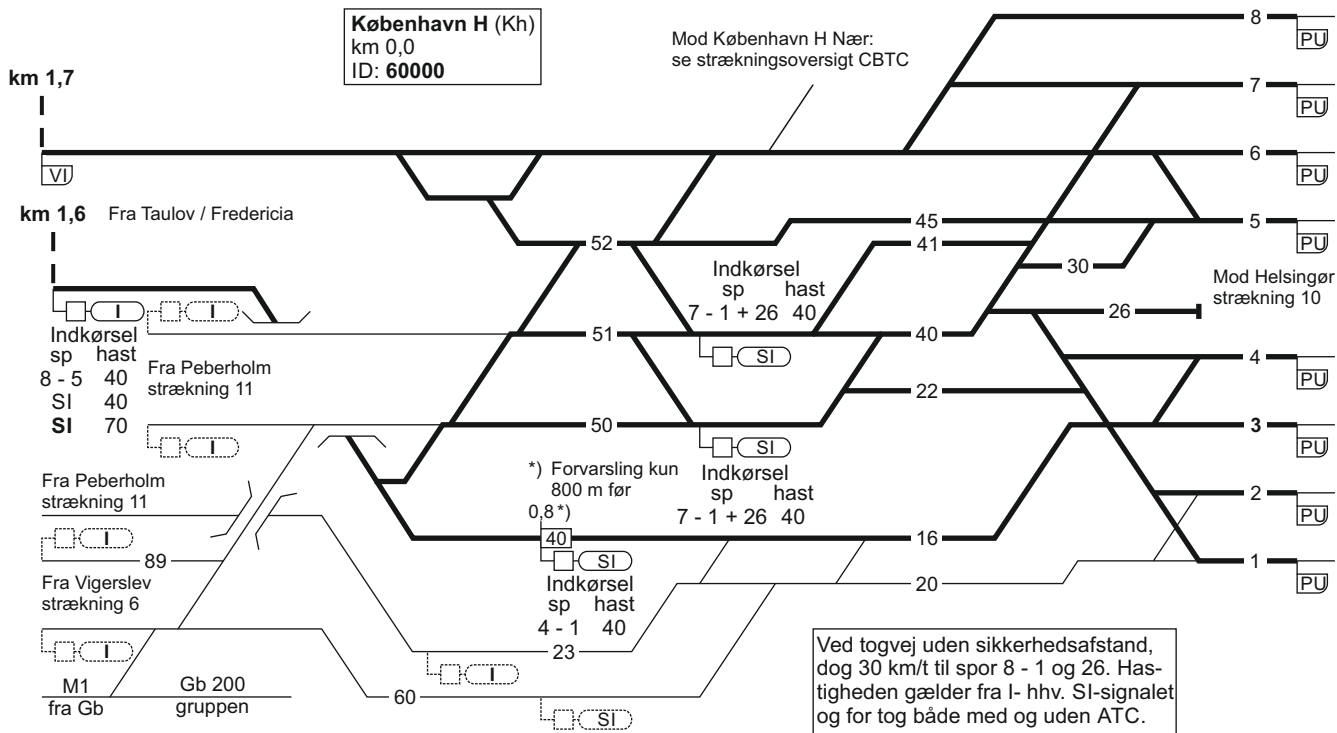

	0,8	
80	40	
80	40	
	0,8	

Togekspeditionssted 1	Togfølgestation 2	Sporbenyttelse 3	Standsningssted 4	Kmp/FC telefonnummer 5
København H.			<p>Spor 1-8 Tog fremført af diesellokomotiv standser med forreste køretøj i røgåbningen. Ved forspandskørsel dog med bagerste lok i røgåbningen.</p> <p>Passagertog der ankommer på hverdage i tidsrummet kl 02.00 - 04.30 og på søndage i tidsrummet kl. 02.00 - 05.30, skal uanset toglængde standse ud for «200m mærket» (SR-mærke 17.20).</p>	<p>Kmp: 82 34 12 14 eller 82 34 26 12</p> <p>GSM-R: 81 99 12 00</p> <p>FC Glostrup: Kh (ekskl.) - Htå (ekskl.) 82 34 18 80</p> <p>GSM-R: 81 99 12 01</p>

Togekspeditionssted 1	Togfølgestation 2	Sporbenyttelse 3	Standingssted 4	Kmp/FC telefonnummer 5
Roskilde				Kmp Roskilde: 46 32 03 04 eller 82 42 41 11 GSM-R: 81 99 12 10 FC Roskilde Øst: Htå - Ro 82 42 41 19 GSM-R: 81 99 12 11 FC Roskilde Midt: Ro - Rg 46 32 49 80 eller 82 42 43 11 GSM-R: 81 99 12 09

Togekspeditionssted 1	Togfølgestation 2	Sporbenyttelse 3	Standingssted 4	Kmp/FC telefonnummer 5
				<p>FC Roskilde Vest: Rg (ekskl.) - Kø (ekskl.) 46 35 69 97 eller 82 42 43 94</p> <p>GSM-R: 81 99 12 15</p> <p>Kø - Od (ekskl.) 82 42 43 93</p> <p>GSM-R Kø - Ng: 81 99 12 14</p> <p>GSM-R Ng (ekskl.) - Od (ekskl.): 81 99 12 15</p>

Togekspeditionssted 1	Togfølgestation 2	Sporbenyttelse 3	Standsningssted 4	Kmp/FC telefonnummer 5
Ringsted			<p>Ved indkørsel fra Sorø Tog som skal sammenkobles i spor 4 og 5: Først ankommende togdel skal standse ud for "240 metermærket" (SR-mærke 17.20.), hvis togdelen består af 1 togsæt. Først ankommende togdel skal standse ud for "S-mærket" (SR-mærke 17.18.), hvis togdelen består af 2 togsæt.</p>	GSM-R: 81 99 12 63
Odense				<p>Kmp: 82 20 11 11 eller 82 20 11 57</p> <p>GSM-R: 81 99 12 68</p>
Årup			<p>København - Fredericia/Taulov: Såfremt PU-signalet foran sporskiftet i spor 3 viser "Forbikørsel tilladt", skal personførende tog fra Tommerup køre helt frem til perron (næste PU-signal).</p> <p>Taulov/Fredericia - København: Personførende tog fra Ejby, der skal ekspederes ved perron og som får signalgivning for indkørsel til spor 3, skal efter endt ekspedition køre helt frem til togvejens endepunkt.</p>	

Togekspeditionssted 1	Togfølgestation 2	Sporbenyttelse 3	Standsningssted 4	Kmp/FC telefonnummer 5
Fredericia			Når tog i spor 10 opformeres med ER-togsæt forrest, skal ER-togsættet placeres med førerrummet 20 meter bag det tændte standsningsmærke.	Kmp Fa: 82 27 23 05 GSM-R: 81 99 12 20 FC Fredericia Øst: Od (ekskl.) - Fa (ekskl.) 82 27 25 16 GSM-R: 81 99 12 21 FC Fredericia Vest: Sno (ekskl.) - TI 82 27 25 15 GSM-R: 81 99 12 24

2. Ringsted - (Lundby)**Strækningshastighed:**

Delstrækning	Strækningshastighed (km/t)
Ringsted - Næstved	180
Næstved - Lundby	160

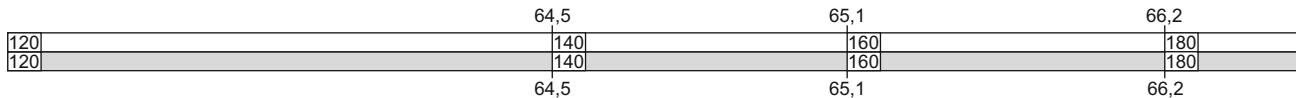
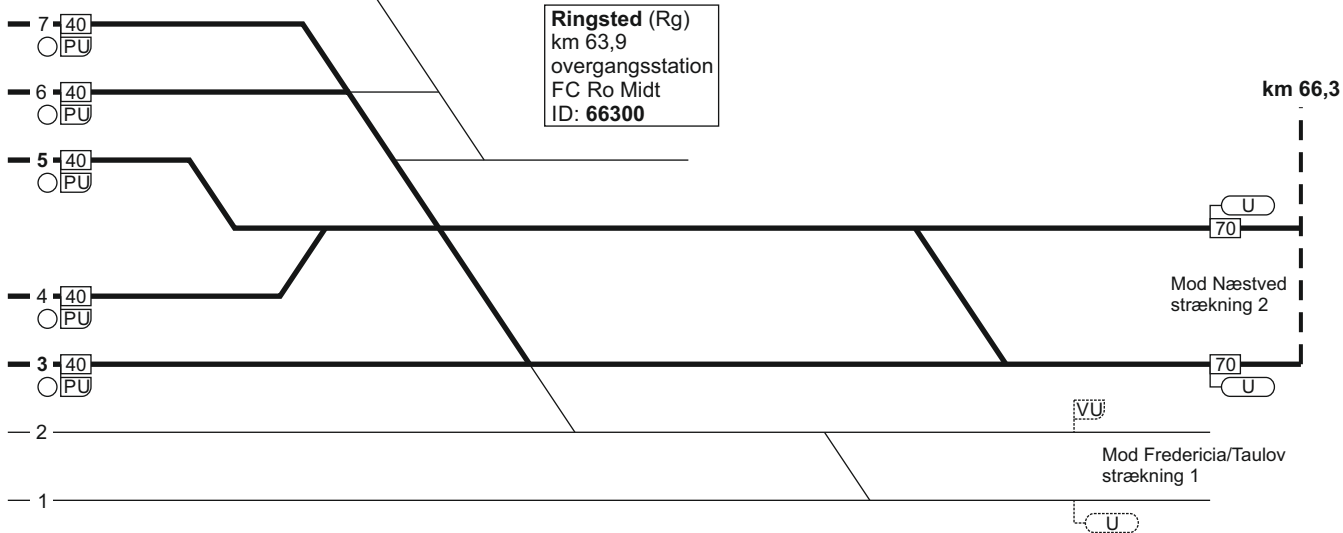
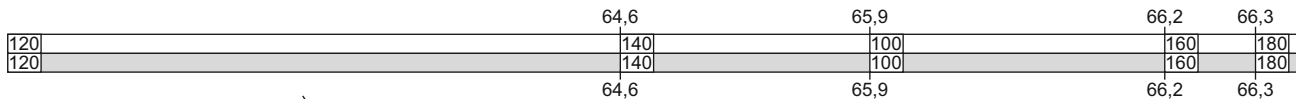

FC Ro Midt
linjeblok / vekselspor
stigning L

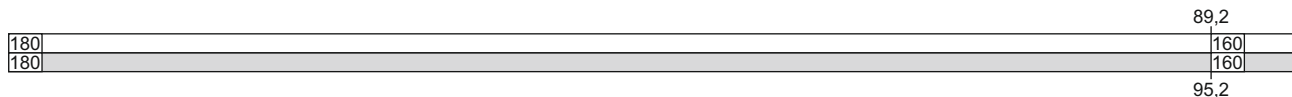

km 66,3

km 89,5

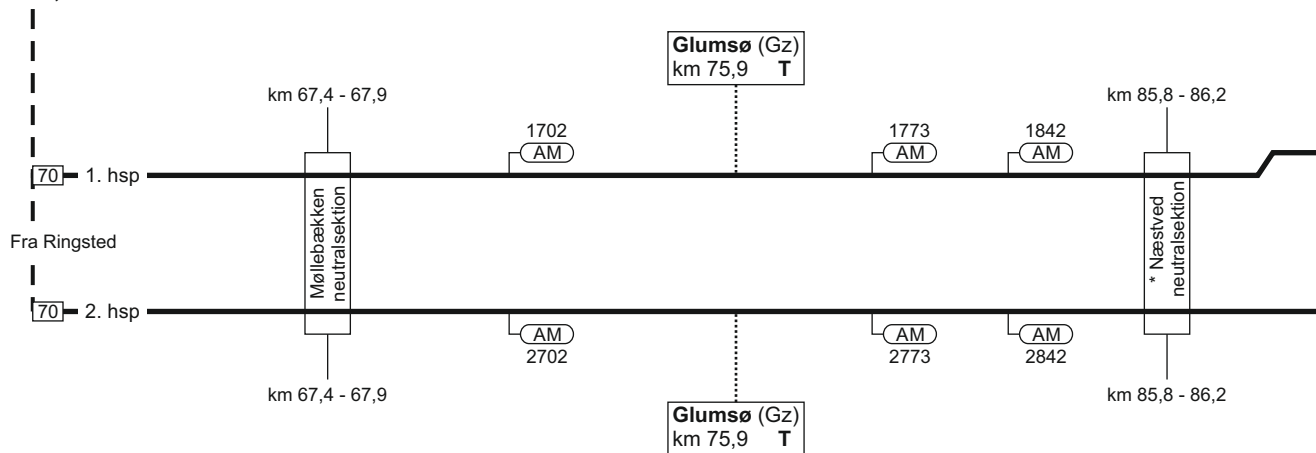

* Neutralsektion ikke i drift

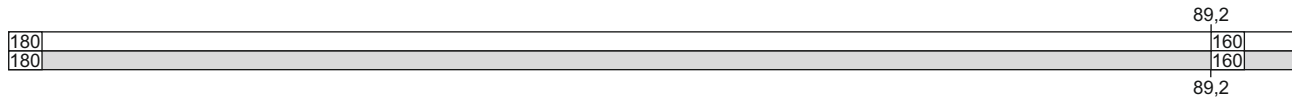

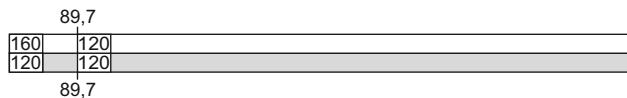

Næstved (Næ)
 km 90,7
 FC Ro Midt
 ID: 66600

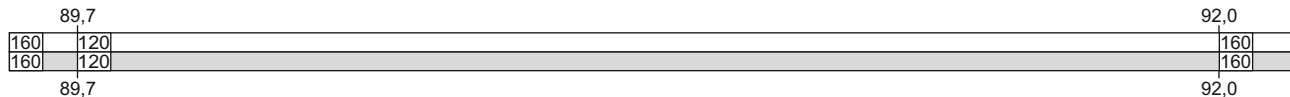
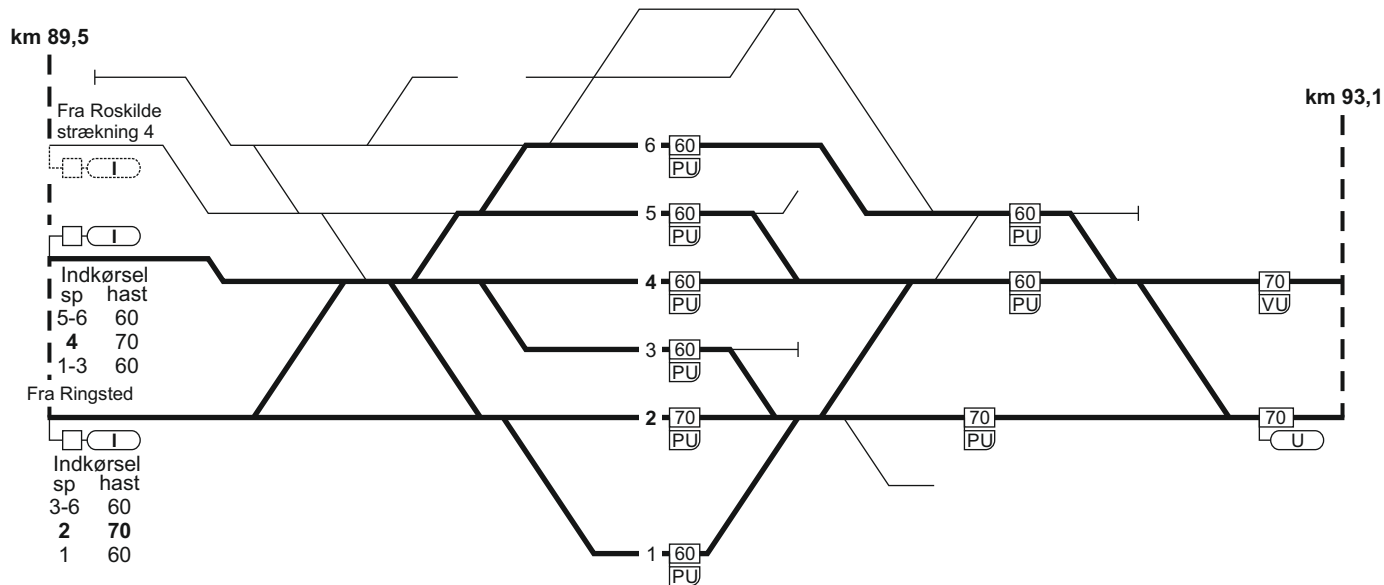

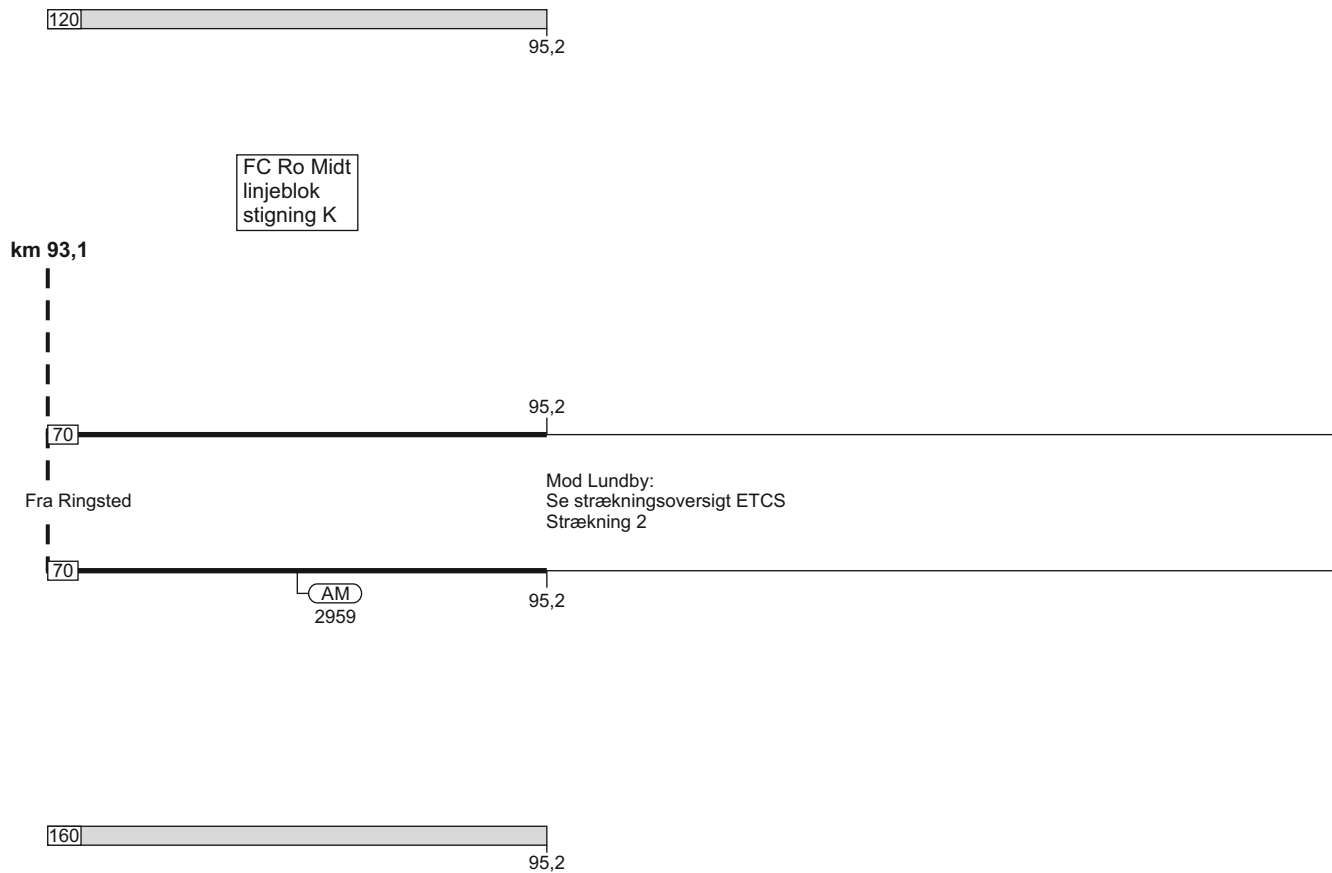

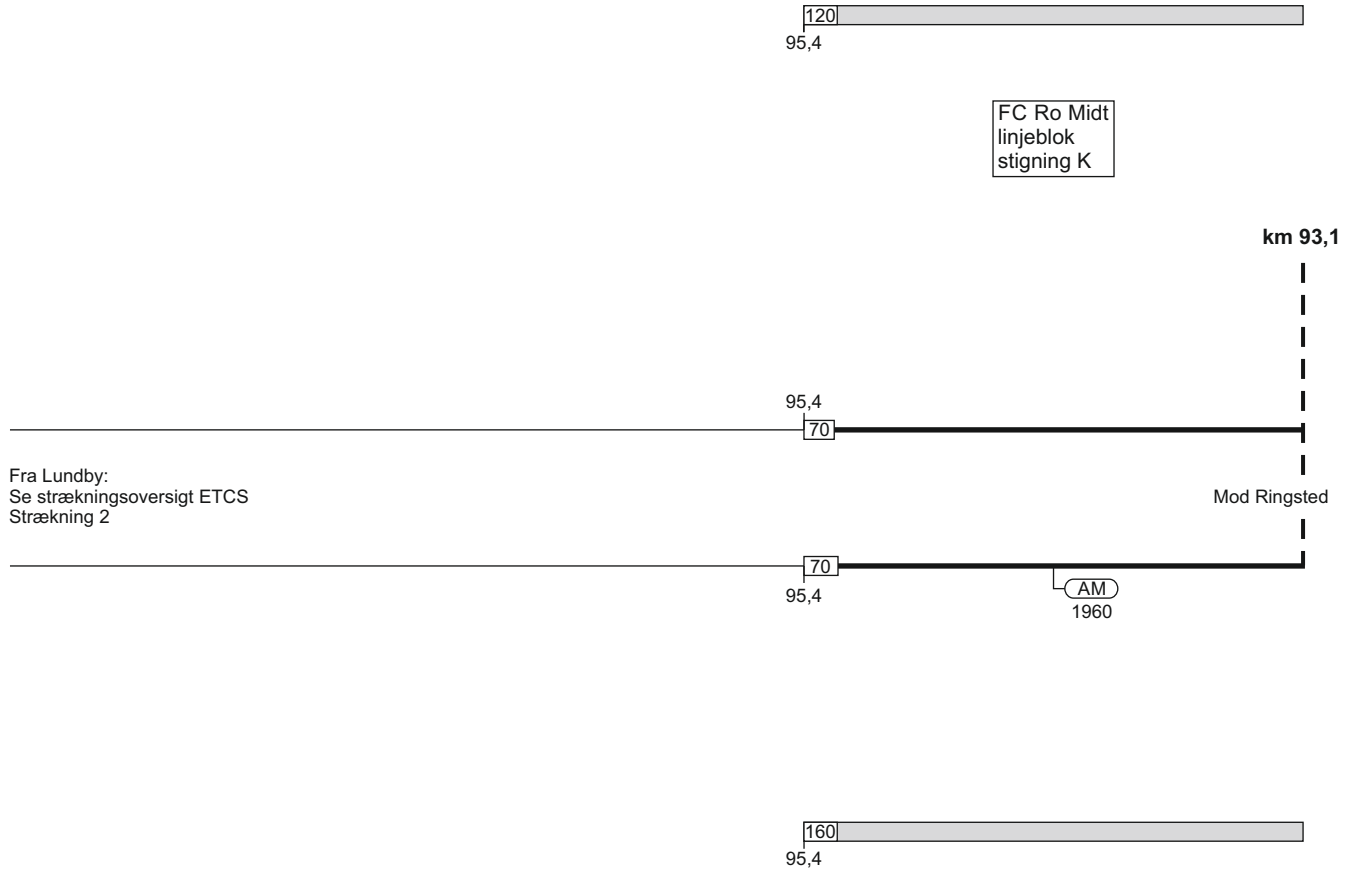

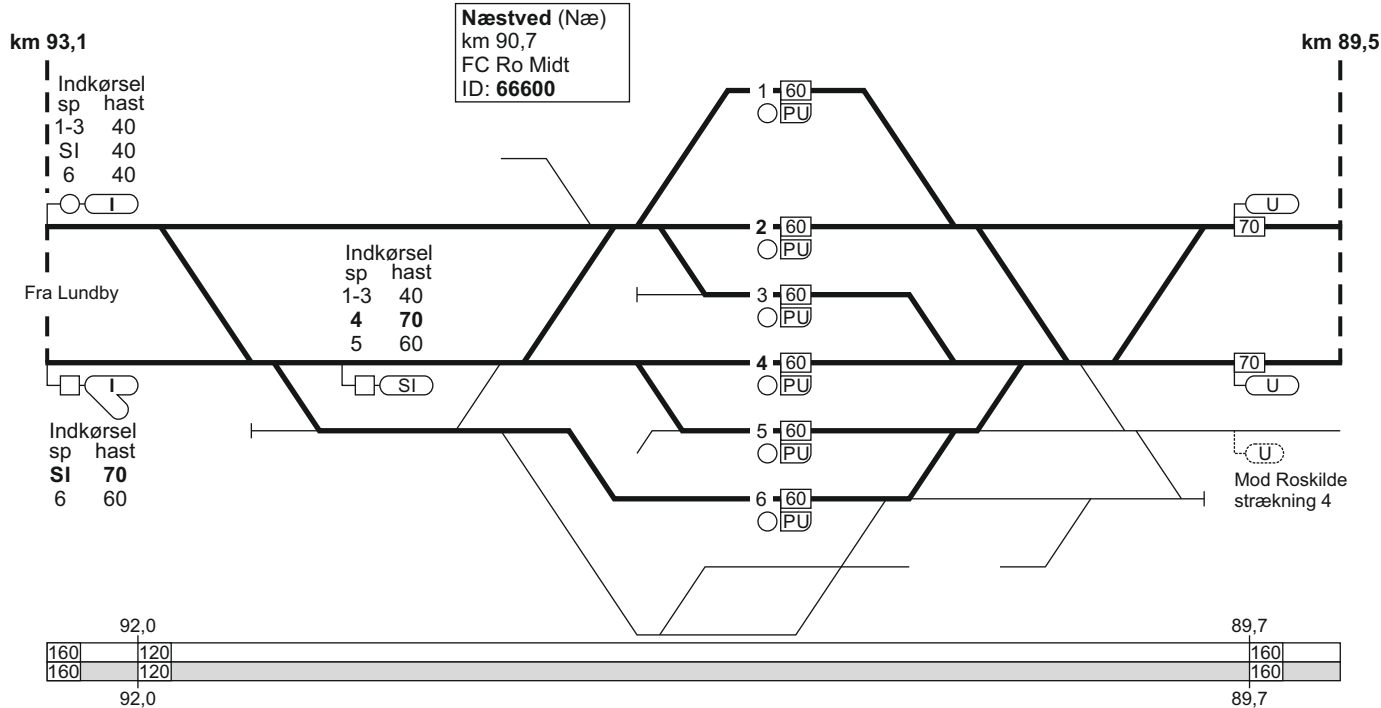
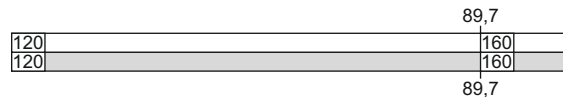

FC Ro Midt
linjeblok / vekselspor
stigning K

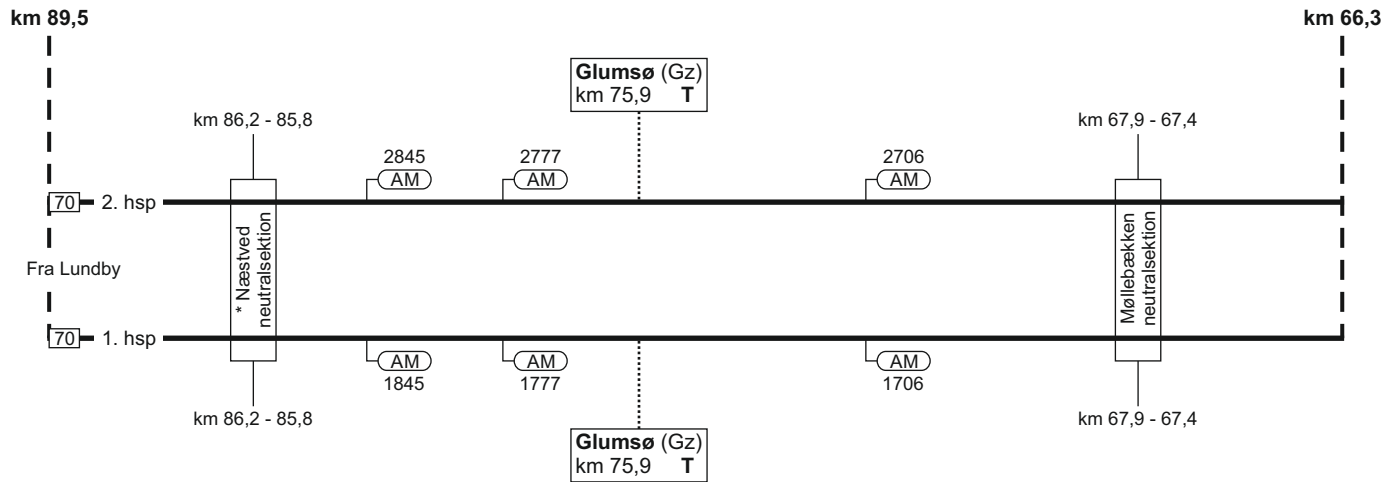
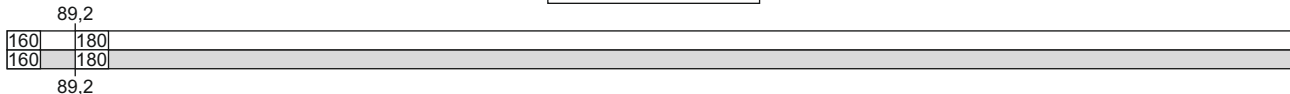

* Neutralsektion ikke i drift

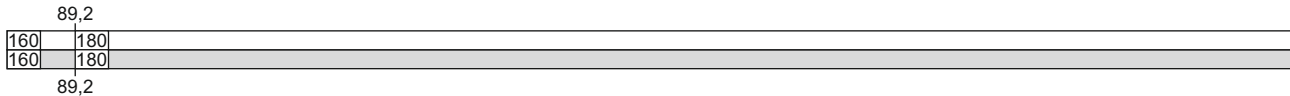

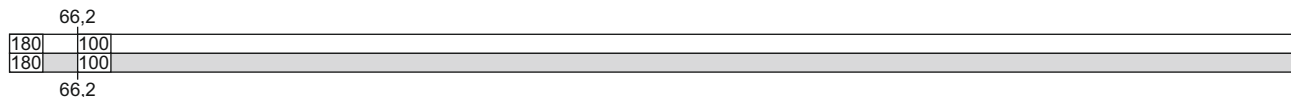

km 66,3

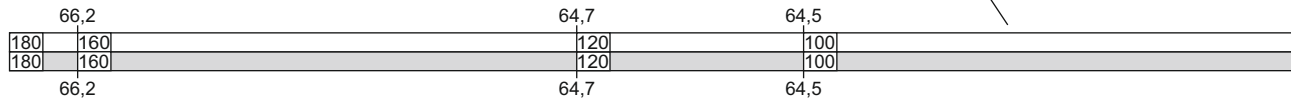
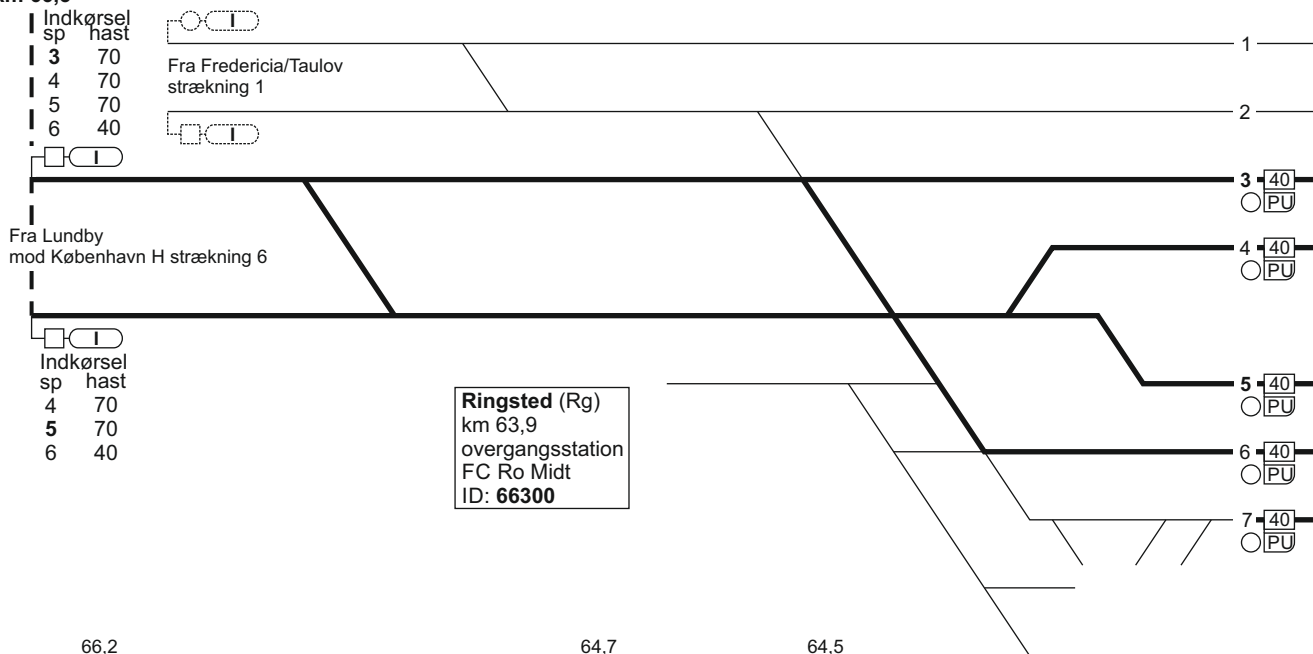

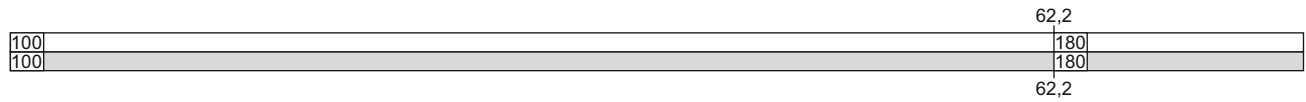
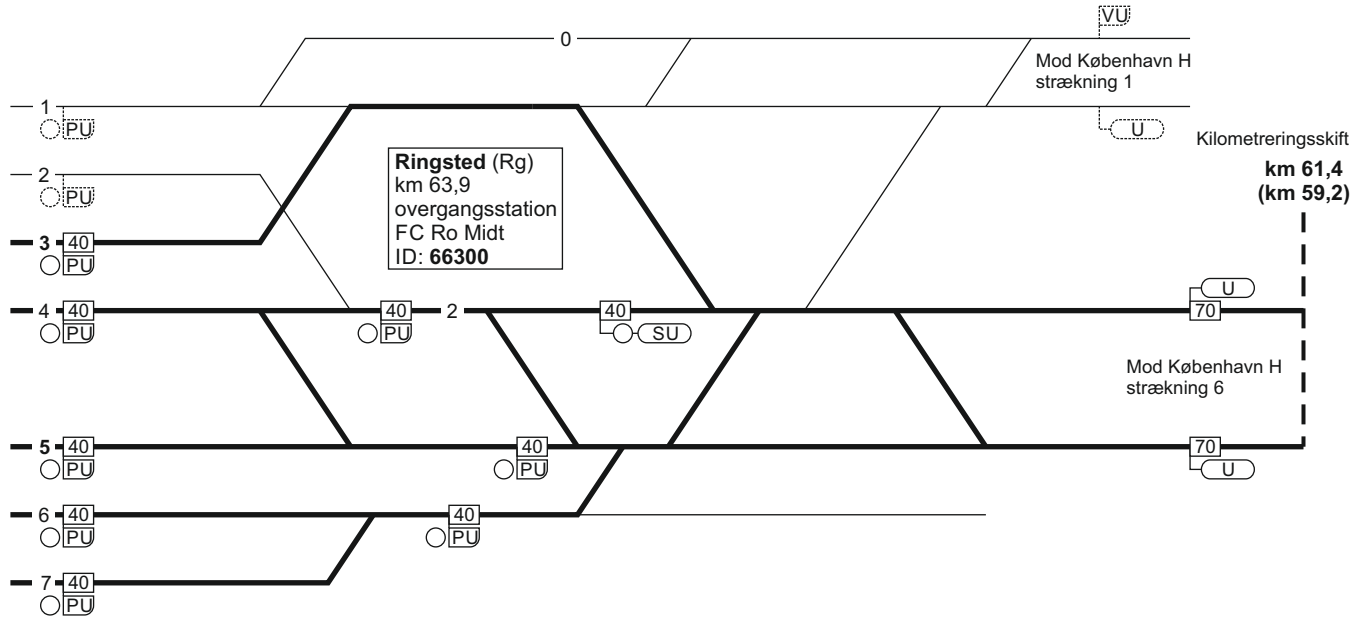
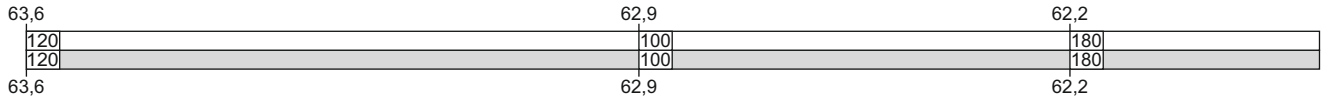

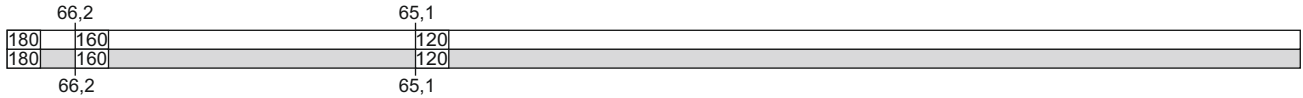

km 66,3

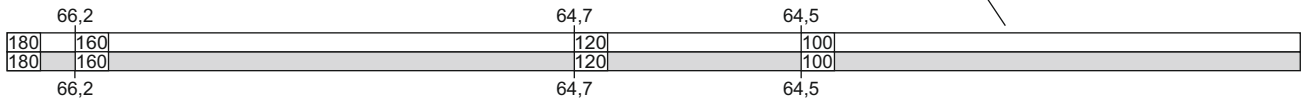
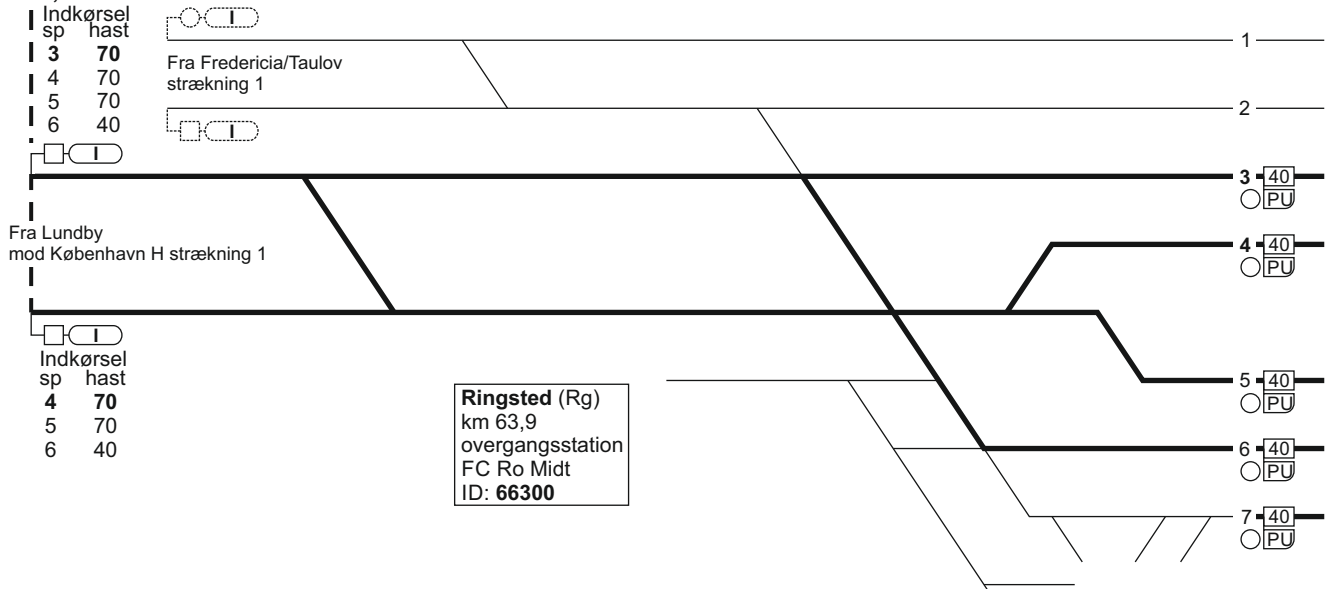

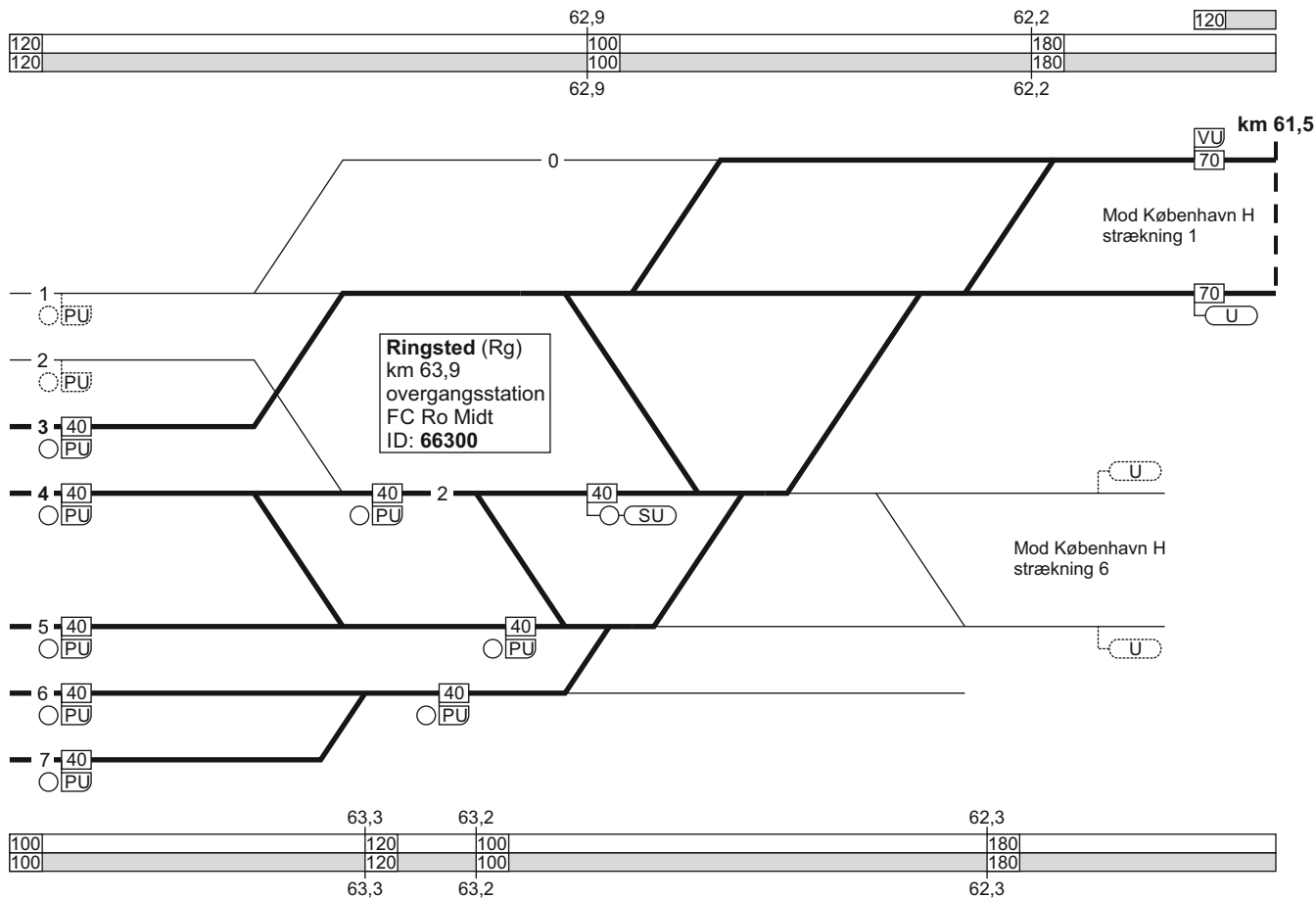

Togekspeditionssted 1	Togfølgestation 2	Sporbenyttelse 3	Standingssted 4	Kmp/FC telefonnummer 5
Ringsted			<p>Ved indkørsel fra Næstved Tog som skal sammenkobles i spor 4 og 5:</p> <p>Først ankommende togdel skal standse ud for "240 metermærket" (SR-mærke 17.20.), hvis togdelen består af 1 togsæt.</p> <p>Først ankommende togdel skal standse ud for "S-mærket" (SR-mærke 17.18.), hvis togdelen består af 2 togsæt.</p>	<p>GSM-R: 81 99 12 63</p> <p>FC Roskilde Midt: Rg - Næ 46 32 49 80 eller 82 42 43 12</p> <p>GSM-R: 81 99 12 09</p>
Næstved				<p>FC Roskilde Midt: Rg - Næ 46 32 49 80 eller 82 42 43 12</p> <p>GSM-R: 81 99 12 66</p>

4. Roskilde - (Gadstrup) og (Holme-Olstrup) - Næstved**Strækningshastighed:**

Delstrækning	Strækningshastighed (km/t)
Roskilde - (Gadstrup) og (Holme-Olstrup) - Næstved	120

Roskilde (Ro)
 km 31,3
 overgangsstation
 ID: 61000

km 32,3

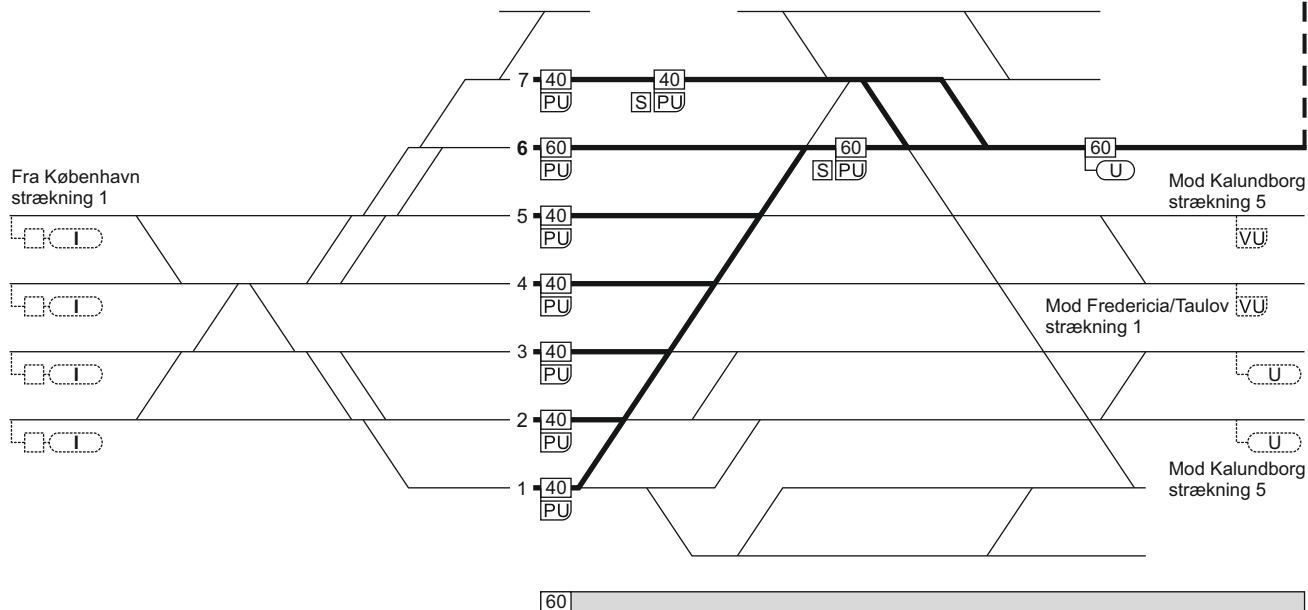

Kmp Ro
linjeblok
stigning L

FC Ro Midt
linjeblok
stigning K

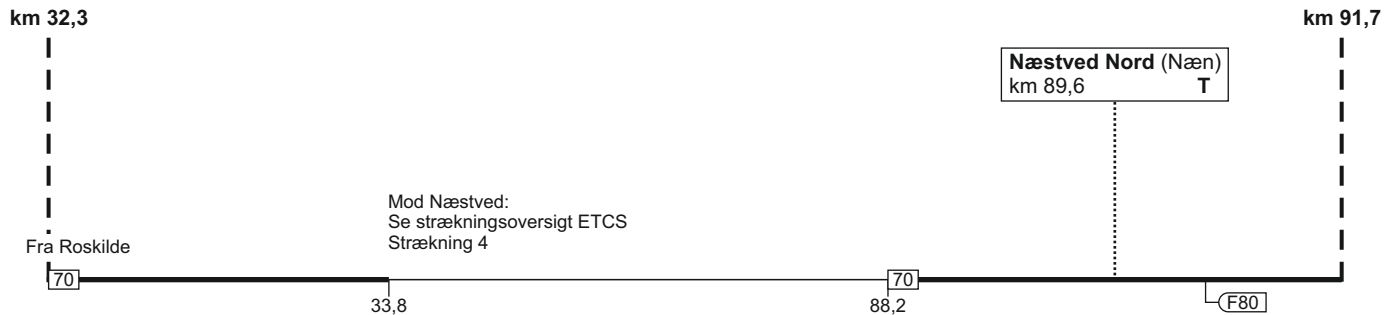

Næstved (Næ)
km 90,7
FC Ro Midt
ID: 66600

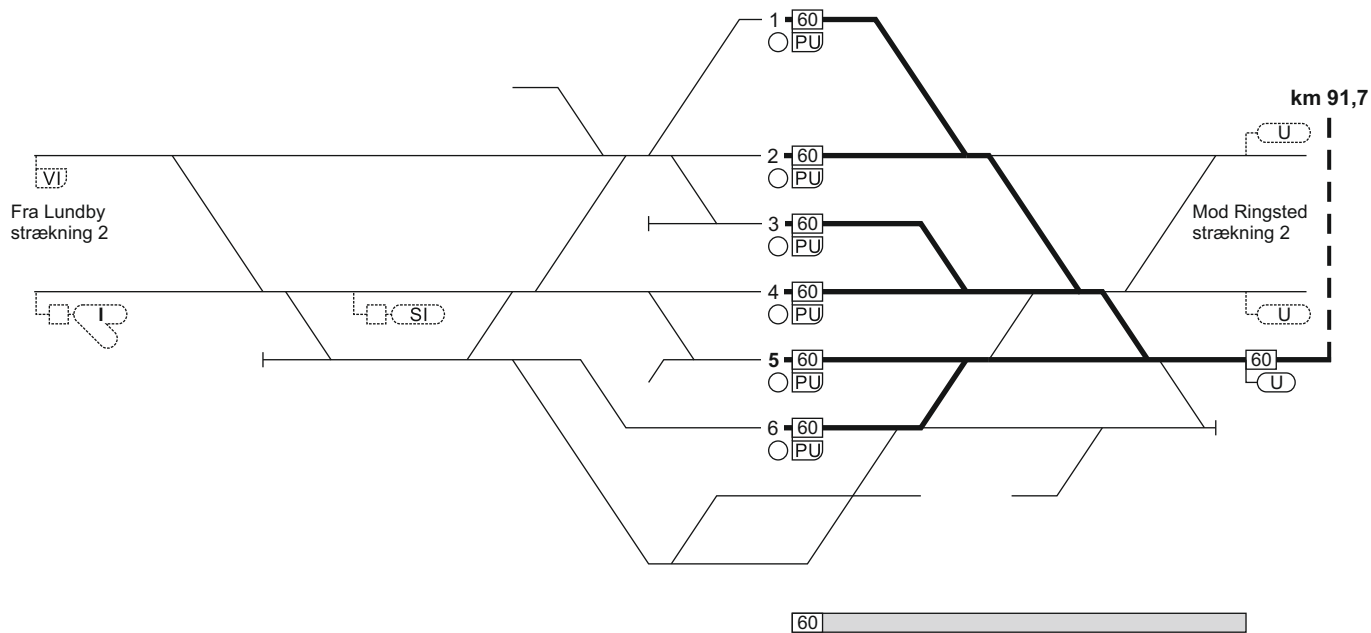

FC Ro Midt
linjeblok
stigning J

Kmp Ro
linjeblok
stigning L

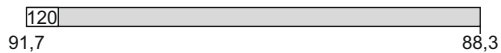
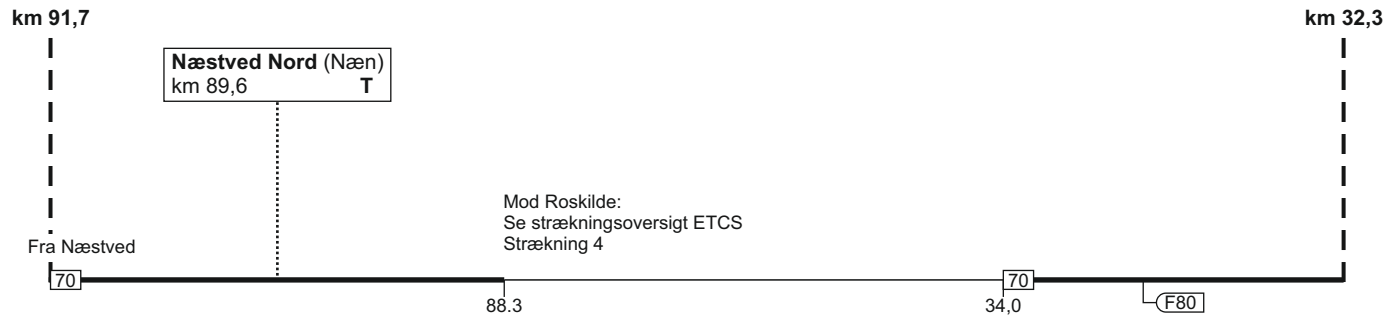

Roskilde (Ro)
 km 31,3
 overgangsstation
 ID: 61000

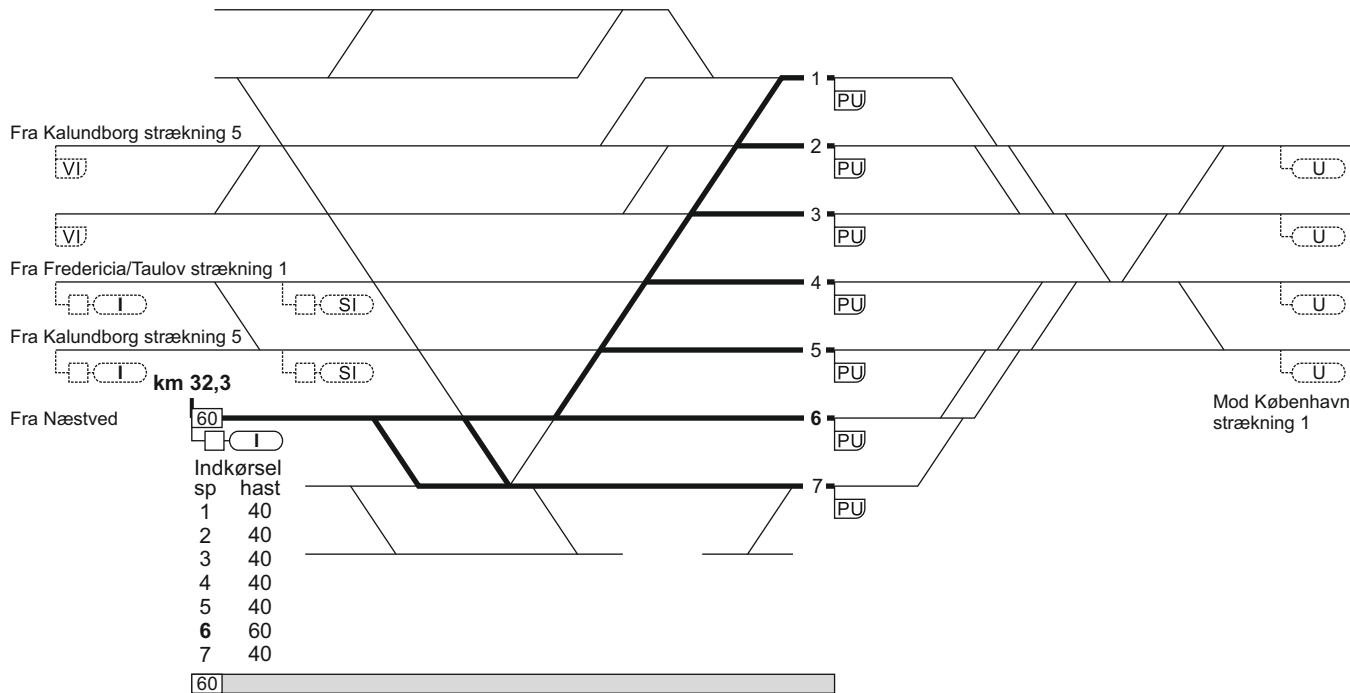

Togekspeditionssted 1	Togfølgestation 2	Sporbenyttelse 3	Standingssted 4	Kmp/FC telefonnummer 5
Roskilde				Kmp Roskilde: 82 42 41 11 GSM-R: 81 99 12 10
Næstved				FC Roskilde Midt: 46 32 49 80 eller 82 42 43 12 GSM-R: 81 99 12 66

5. Roskilde - Kalundborg**Strækningshastighed:**

Delstrækning	Strækningshastighed (km/t)
Roskilde - Holbæk	160
Holbæk - Kalundborg	120

Roskilde (Ro)
 km 31,3
 overgangsstation
 ID: 61000

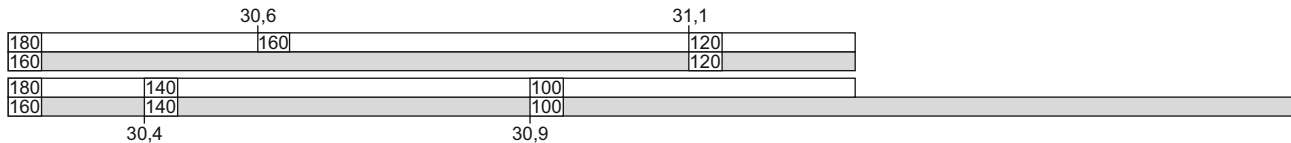
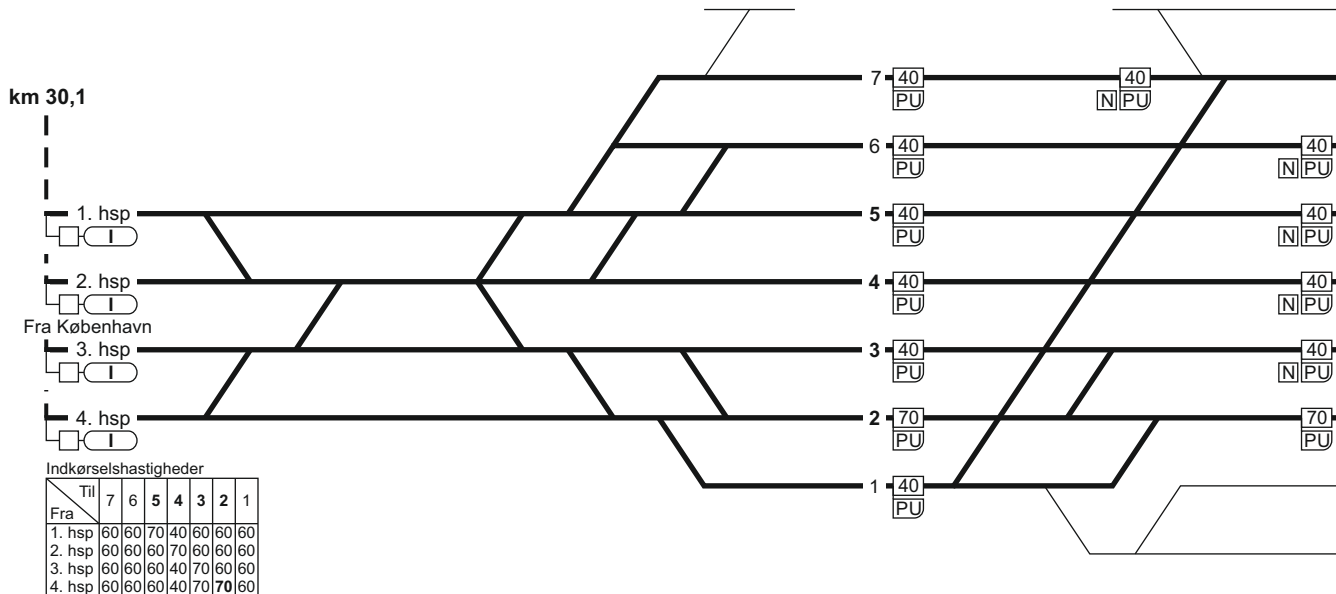

Roskilde (Ro)
km 31,3
overgangsstation
ID: 61000

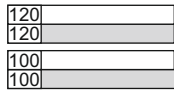
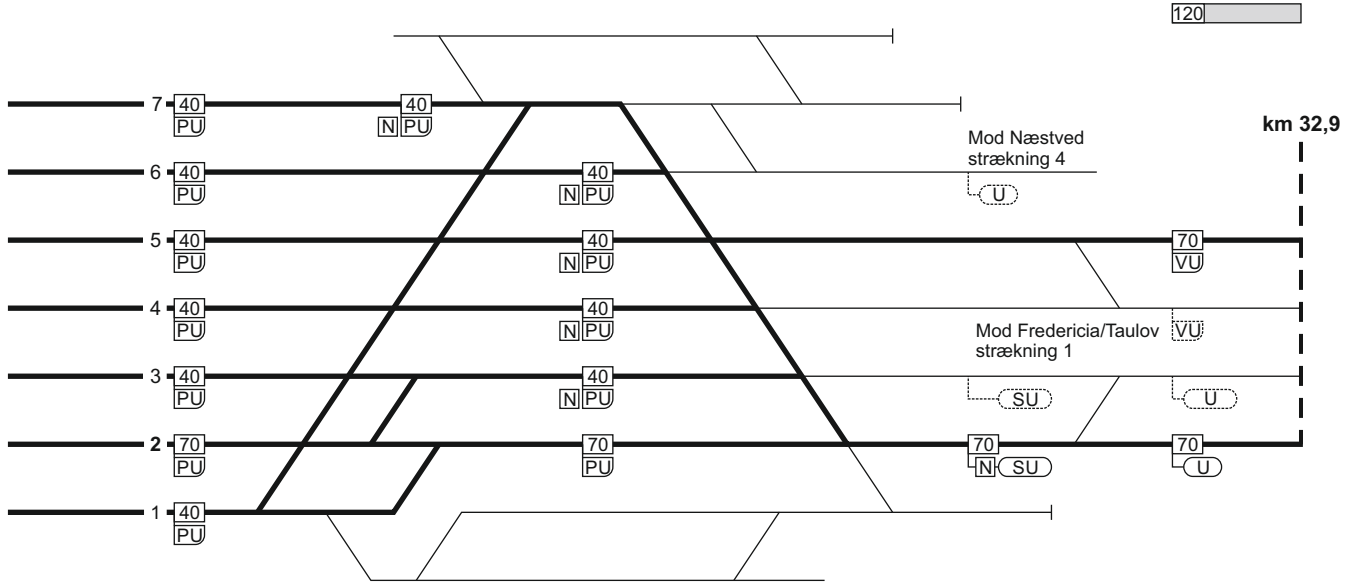

FC Ro Nordvest
linjeblok
stigning M

FC Ro Nordvest
linjeblok / vekselspor
stigning J

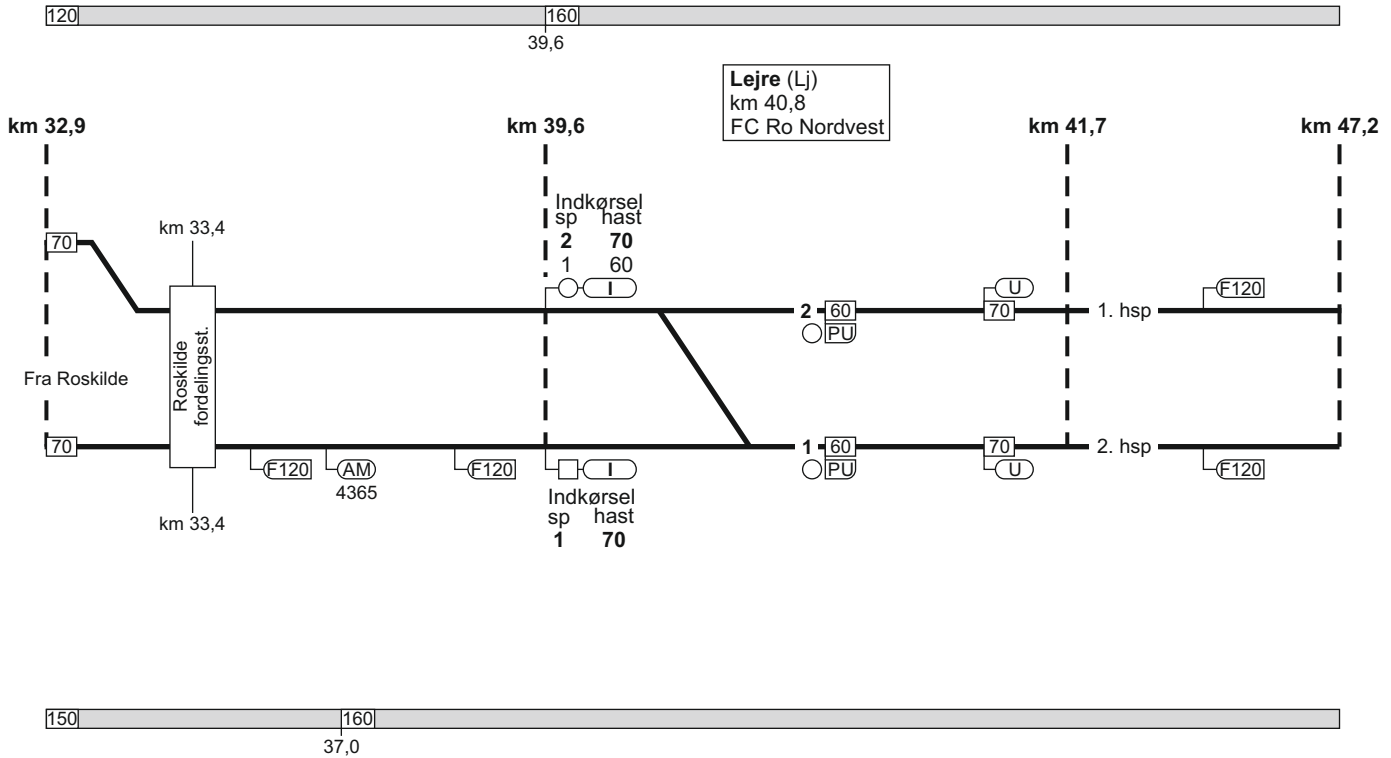

FC Ro Nordvest
linjeblok / vekselspor
stigning M

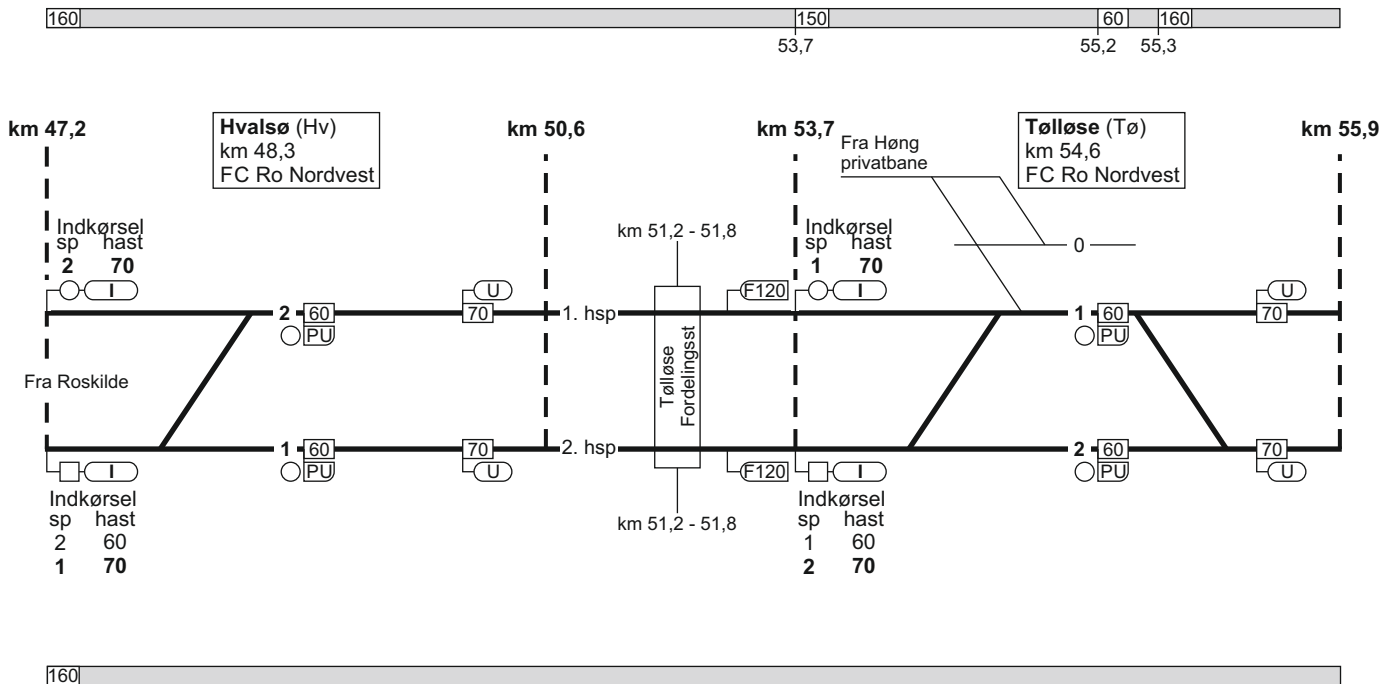

FC Ro Nordvest
linjeblok / vekselspor
stigning K

FC Ro Nordvest
linjeblok / vekselspor
stigning M

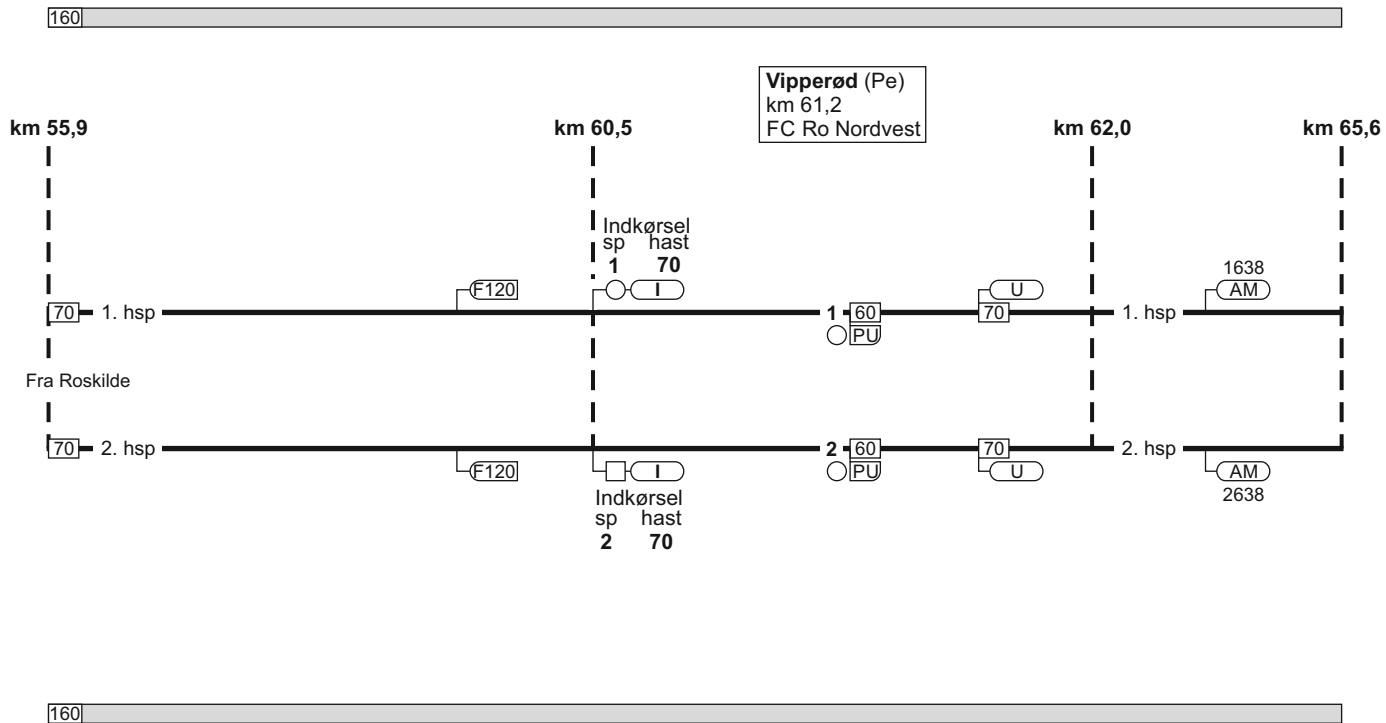

FC Ro Nordvest
linjeblok
stigning L

FC Ro Nordvest
linjeblok
stigning K

Regstrup (Rt)
km 75,2
FC Ro Nordvest

Knabstrup (Ks)
km 79,4
T

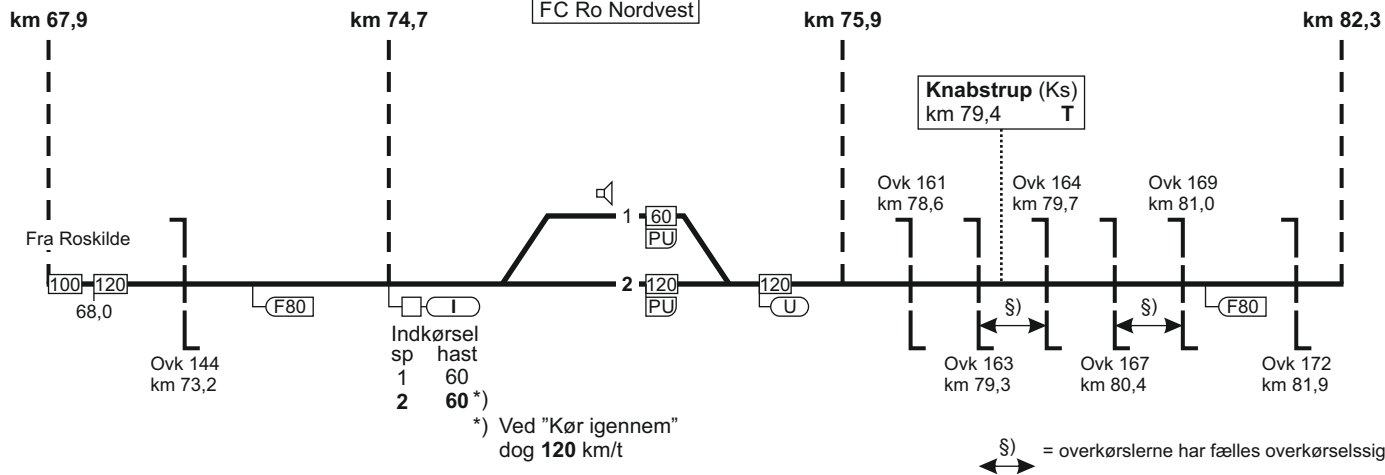

FC Ro Nordvest
linjeblok
stigning L

FC Ro Nordvest
linjeblok
stigning K

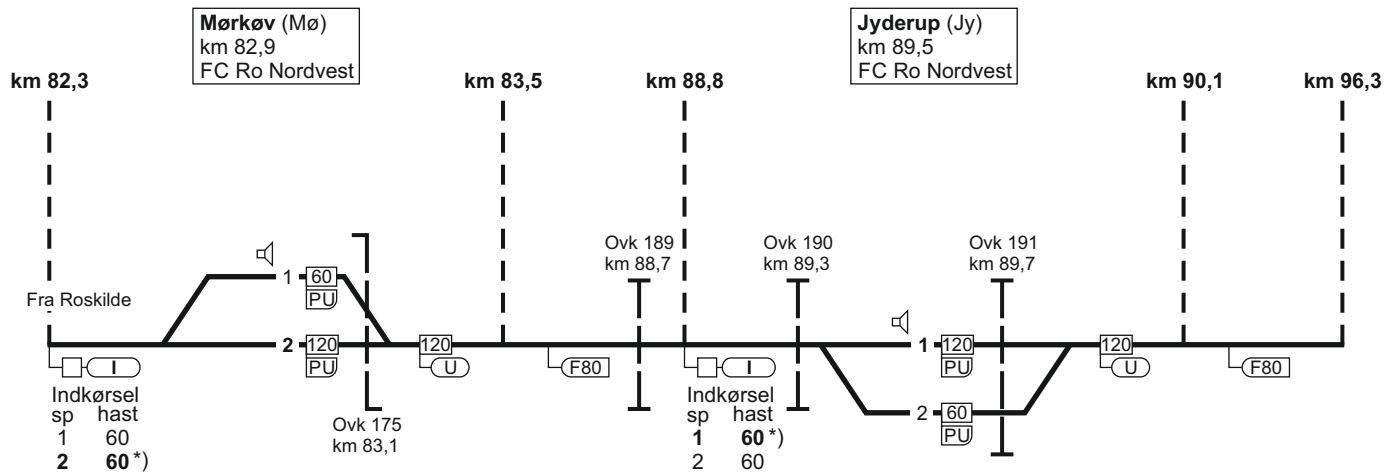

*) Ved "Kør igennem"
dog 120 km/t

FC Ro Nordvest
linjeblok
stigning M

Kalundborg (Kb)
km 110,6
FC Ro Nordvest
ID: 63005

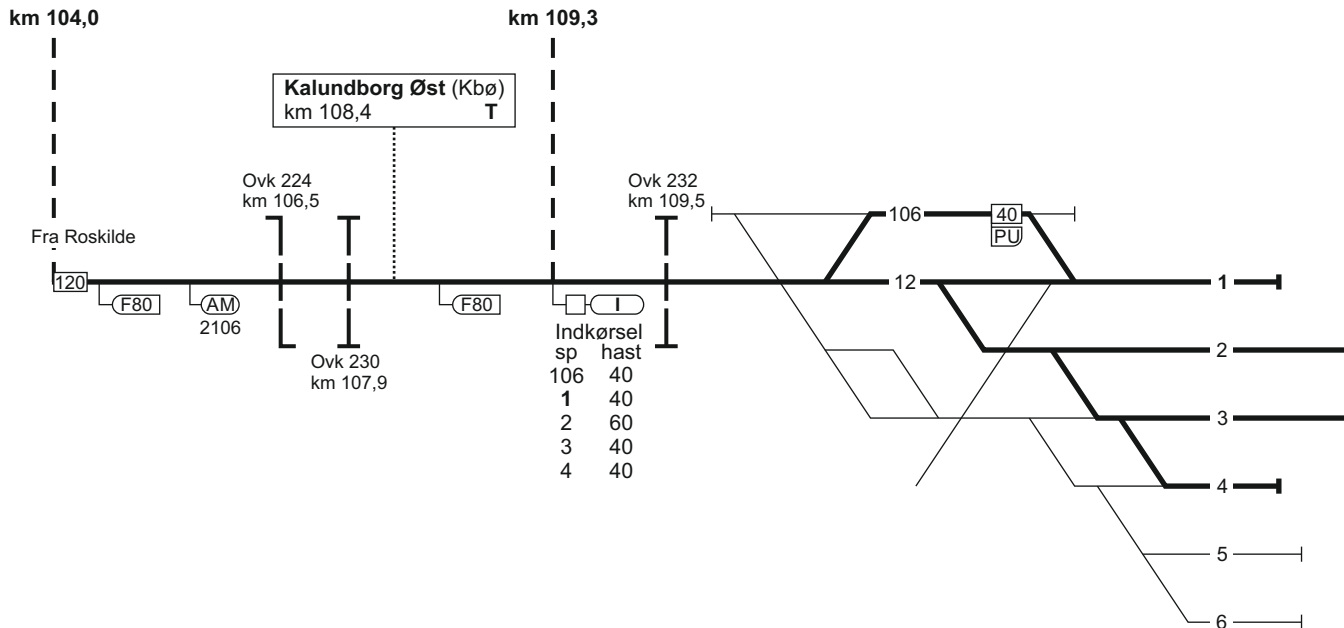

Værslev (Væ)
km 102,8
FC Ro Nordvest

FC Ro Nordvest
linjeblok
stigning L

Svebølle (Se)
km 97,2
FC Ro Nordvest

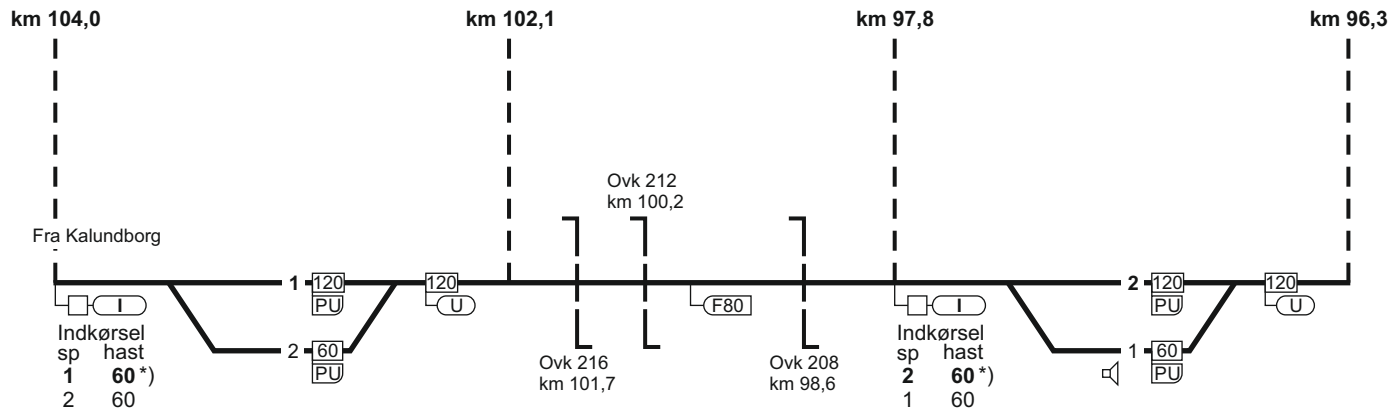

*) Ved "Kør igennem"
dog 120 km/t

FC Ro Nordvest
linjeblok
stigning K

Jyderup (Jy)
km 89,5
FC Ro Nordvest

FC Ro Nordvest
linjeblok
stigning L

Mørkøv (Mø)
km 82,9
FC Ro Nordvest

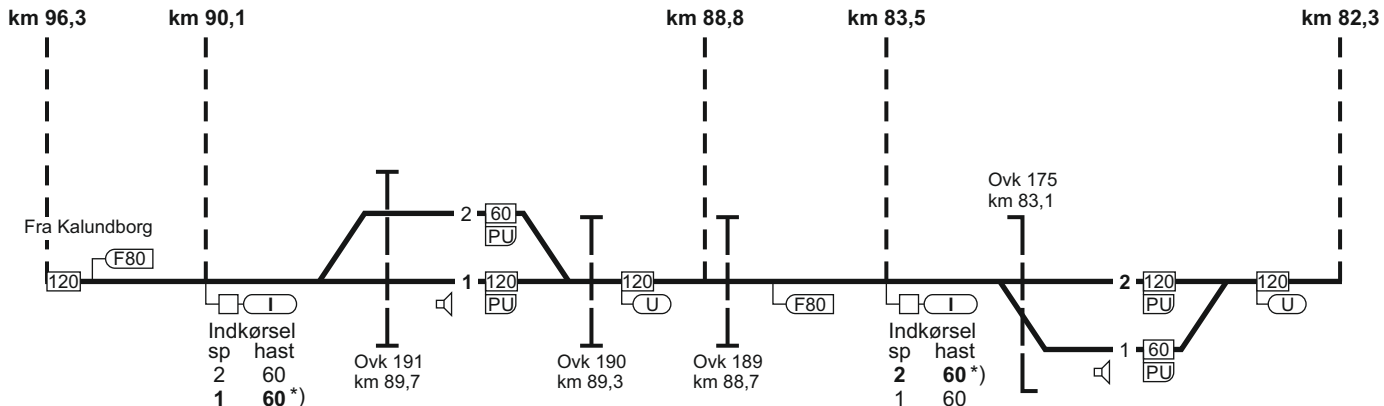

*) Ved "Kør igennem" dog 120 km/t

FC Ro Nordvest
linjeblok
stigning K

FC Ro Nordvest
linjeblok
stigning K

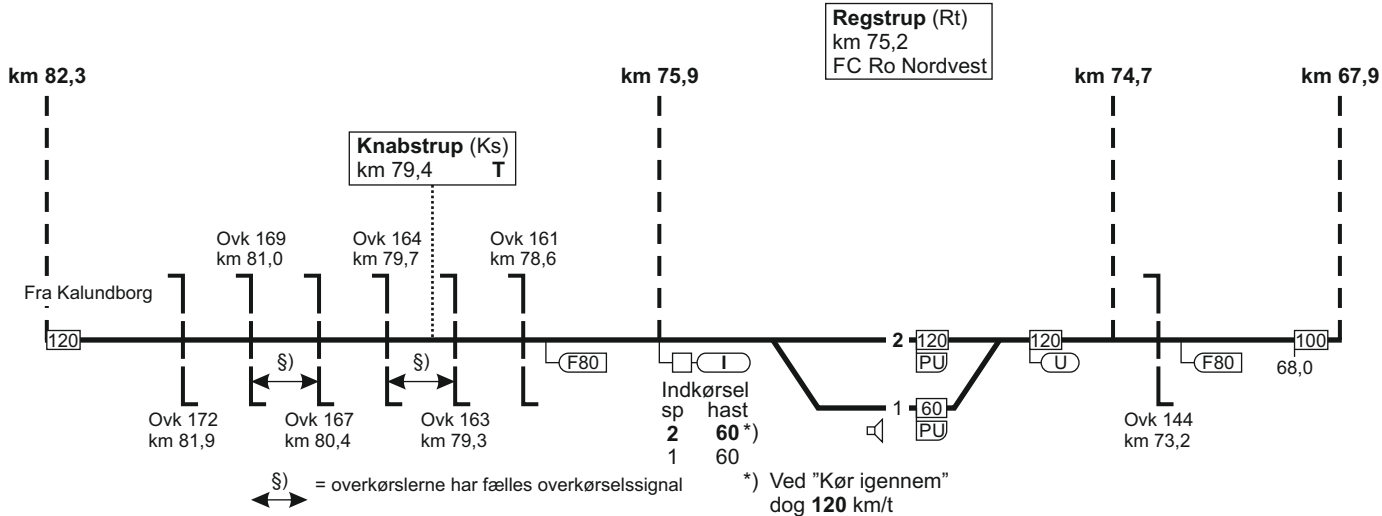



Holbæk (Hk)
 km 67,0
 overgangsstation
 FC Ro Nordvest
 ID: 66400

km 0,8

km 65,6

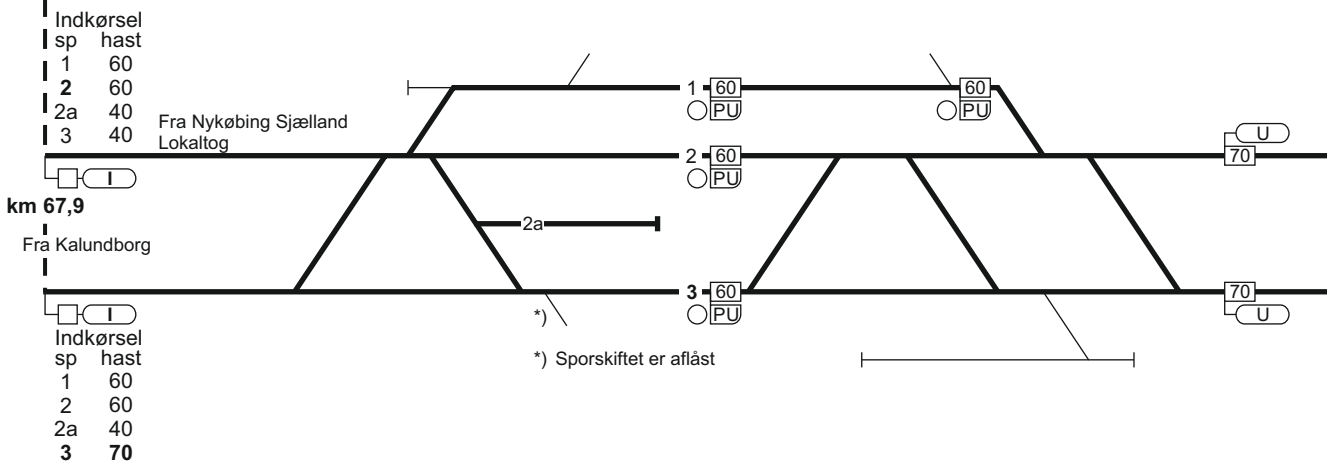

km 67,9

Fra Kalundborg



65,7

FC Ro Nordvest
linjeblok / vekselspor
stigning J

FC Ro Nordvest
linjeblok / vekselspor
stigning M

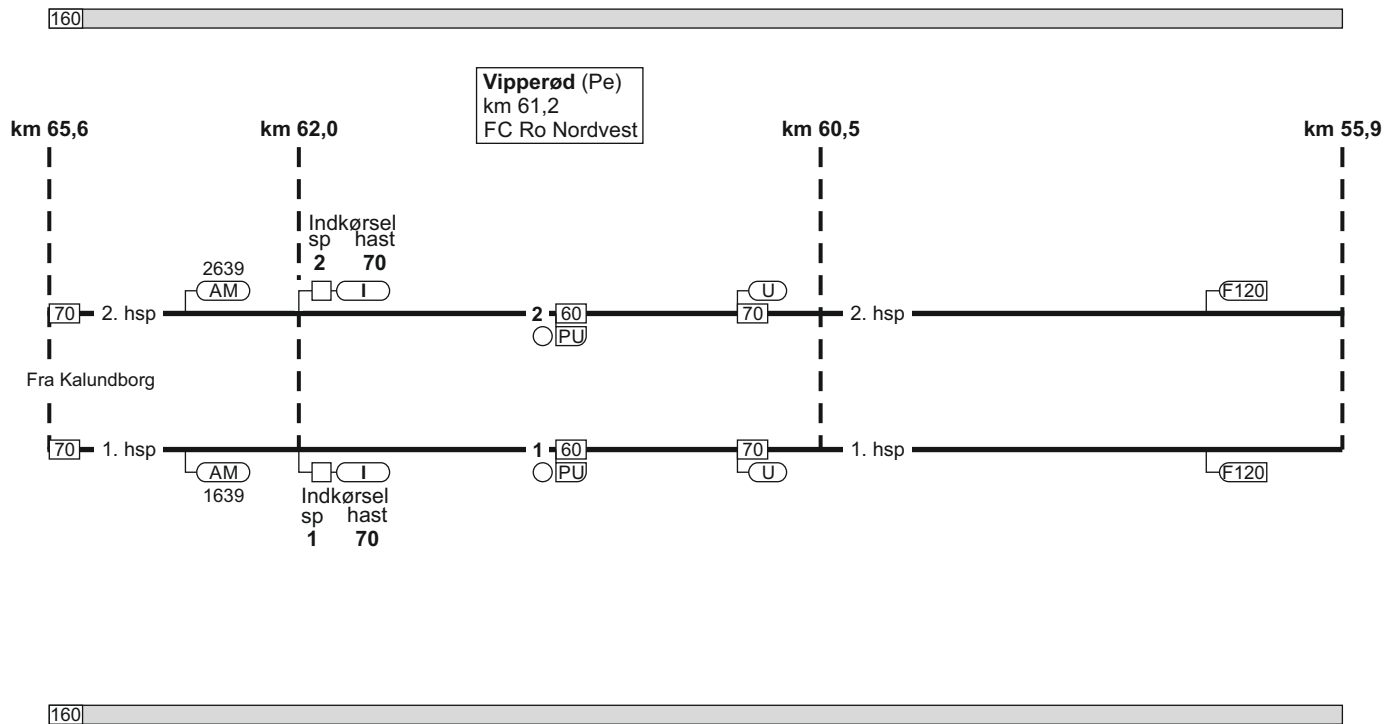

FC Ro Nordvest
linjeblok / vekselspor
stigning K

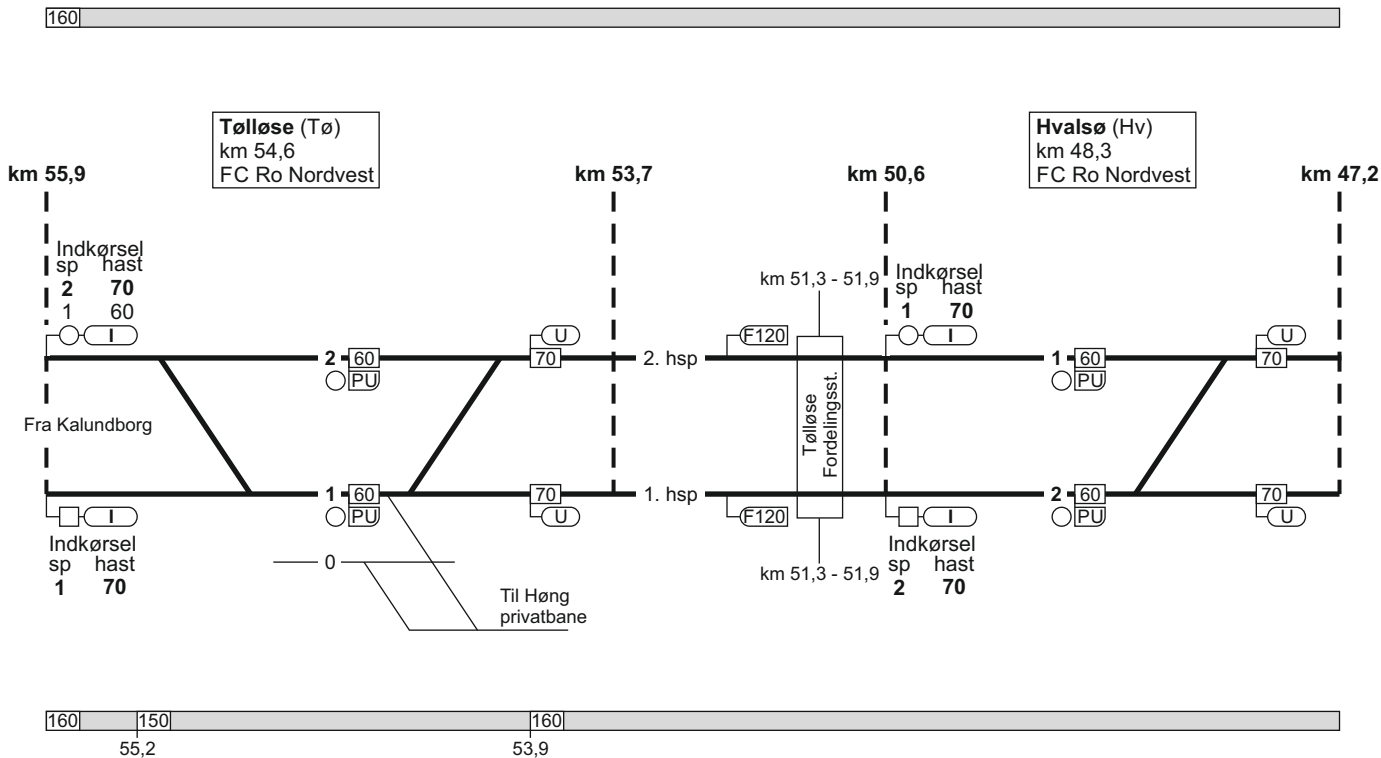

FC Ro Nordvest
linjeblok / vekselspor
stigning M

FC Ro Nordvest
linjeblok
stigning K

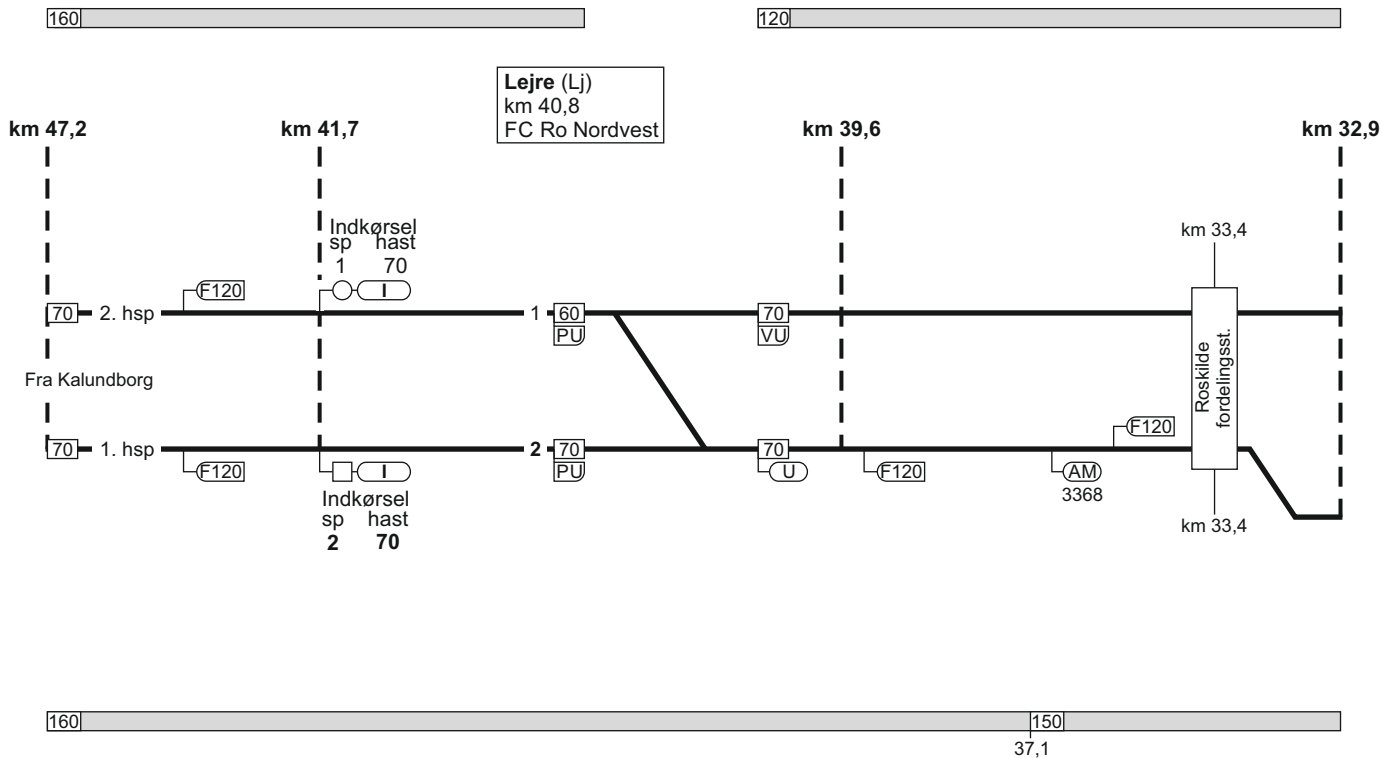

Roskilde (Ro)
 km 31,3
 overgangsstation
 ID: 61000

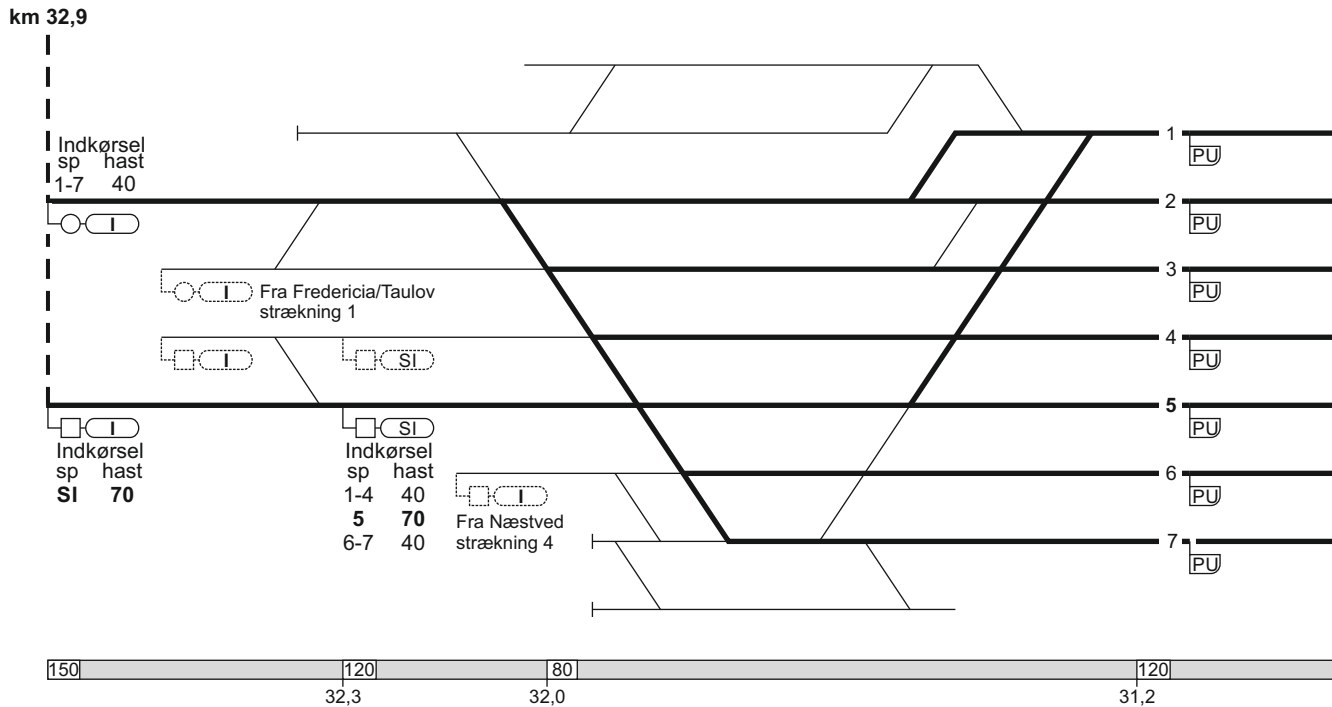

Roskilde (Ro)
 km 31,3
 overgangsstation
 ID: 61000

180
160
180
160

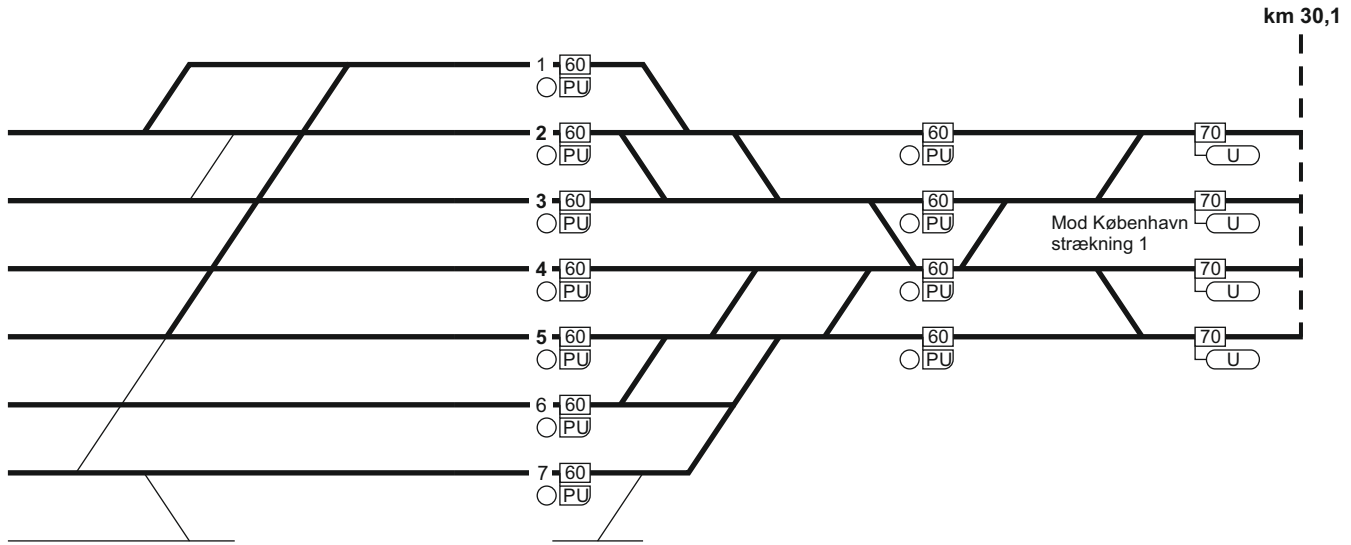

	31,1		30,6	
120	160		180	
120	140		160	
120				180
				160

30,4

Togekspeditionssted 1	Togfølgestation 2	Sporbenyttelse 3	Standsningssted 4	Kmp/FC telefonnummer 5
Roskilde				Kmp Roskilde: 82 32 03 04 GSM-R: 81 99 12 10 FC Roskilde Nordvest: Ro (ekskl.) - Kb 82 42 41 20 GSM-R (Ro) - Hk: 81 99 12 13 GSM-R (Hk) - Kb: 81 99 12 30
Kalundborg				GSM-R: 81 99 12 29

6. København H - Vigerslev - (Avedøre Havnevej) og (Bjæverskov) - Ringsted

Strækningshastighed:

Delstrækning	Strækningshastighed (km/t)
København H - Vigerslev	120
Vigerslev - (Avedøre Havnevej) og (Bjæverskov) - Ringsted	180

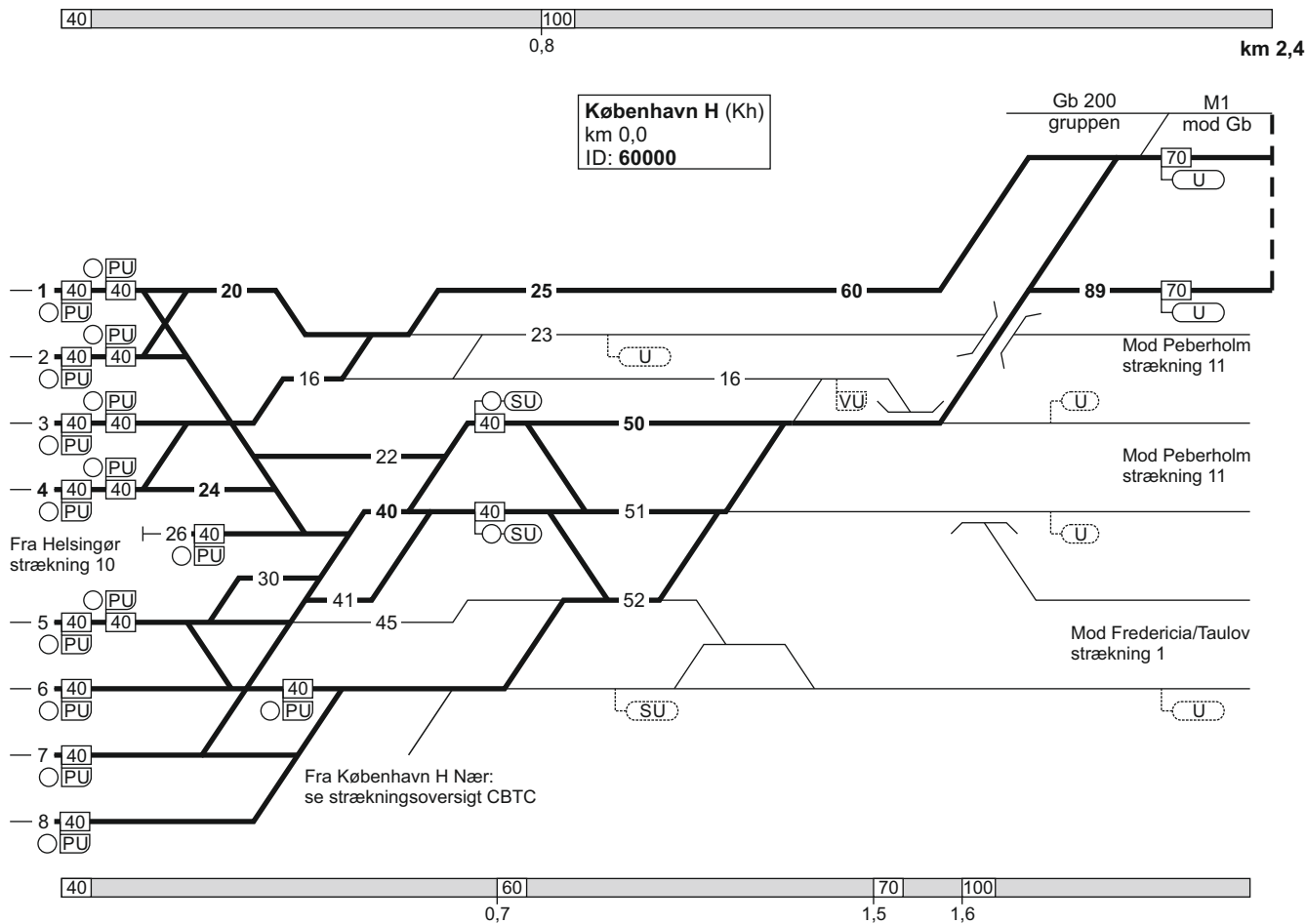

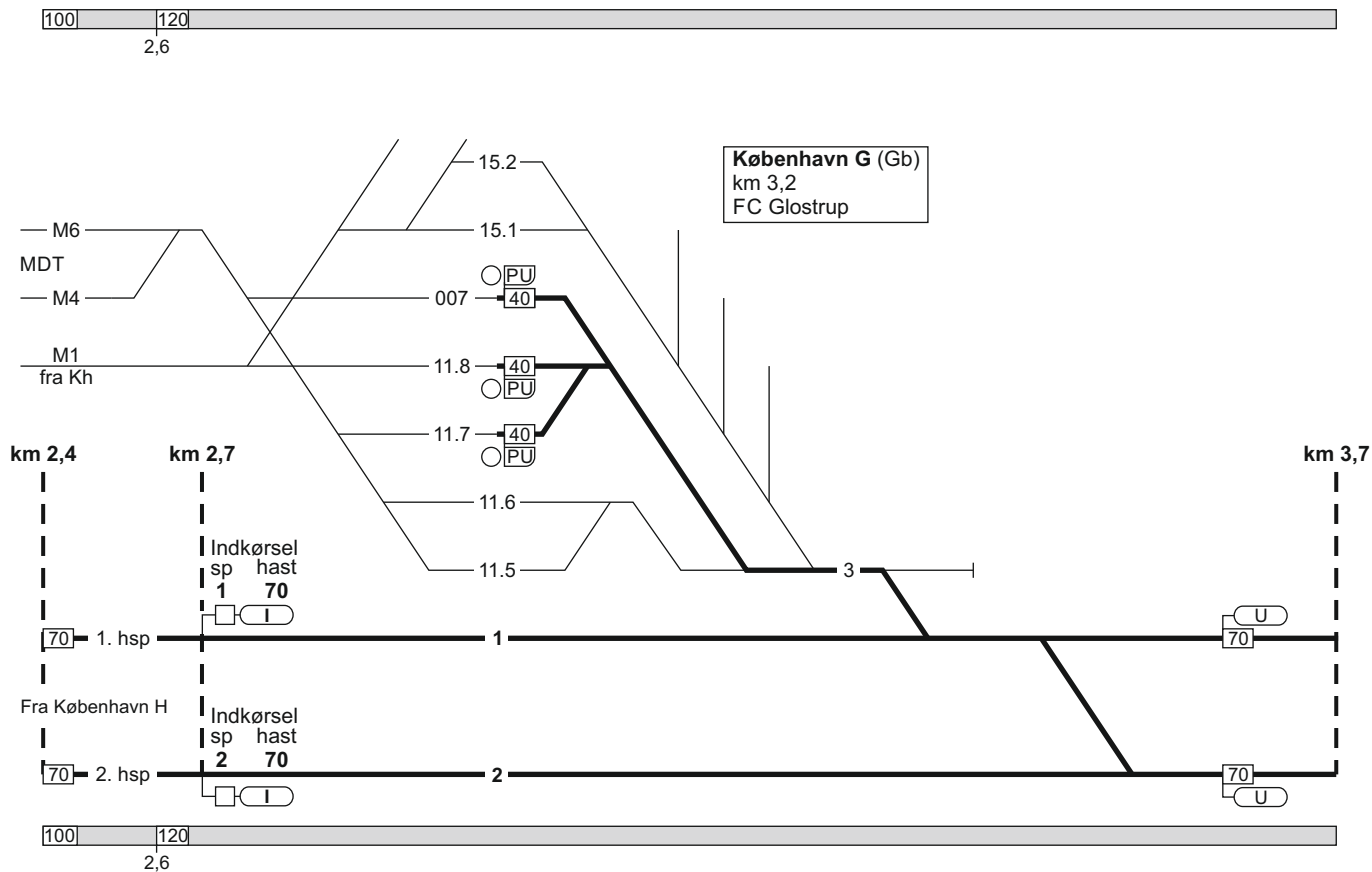

FC Glostrup
linjeblok / vekselspor
stigning L

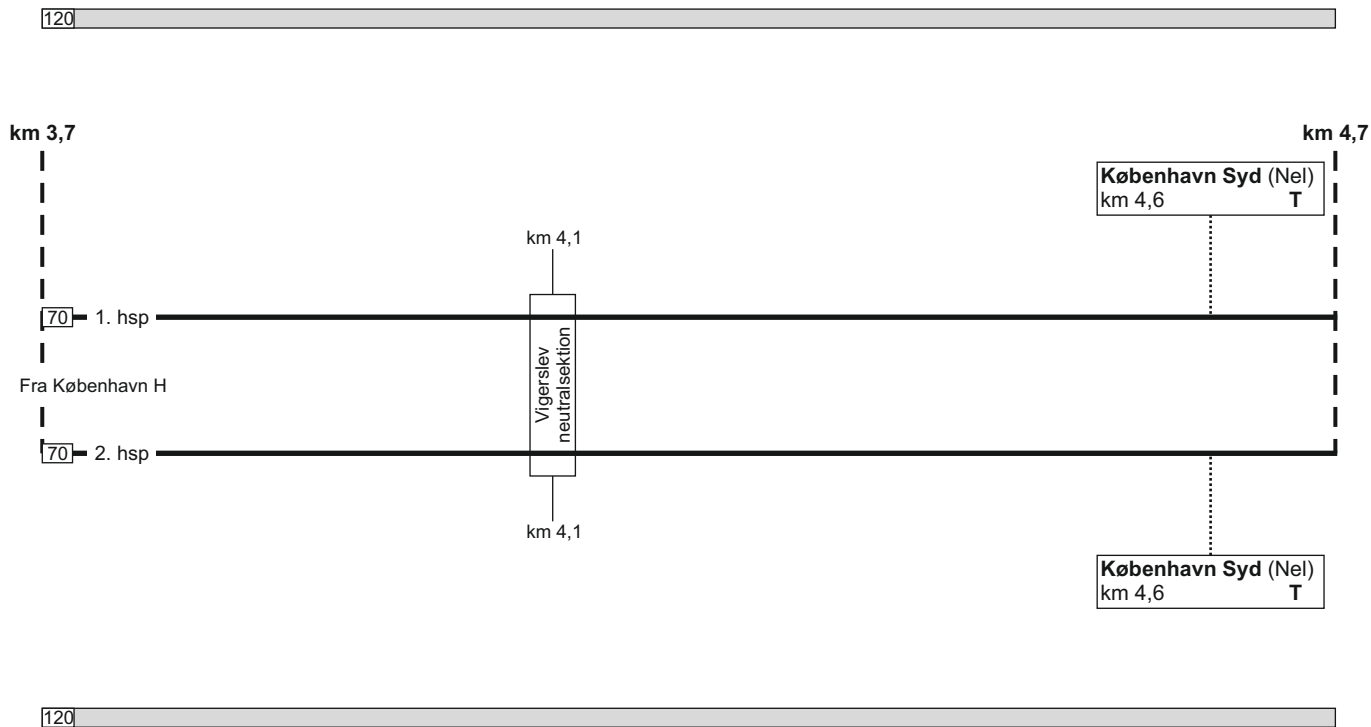

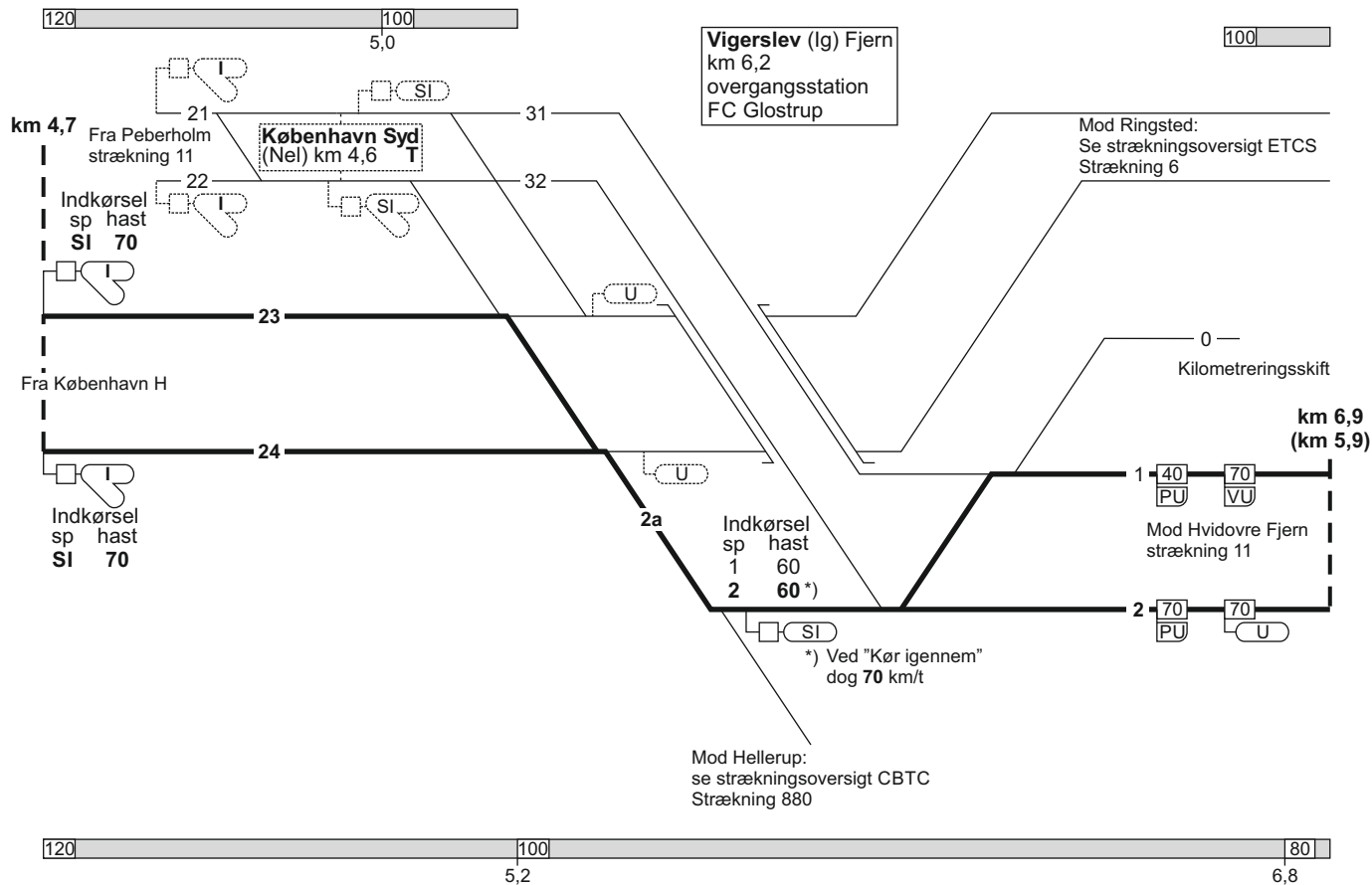

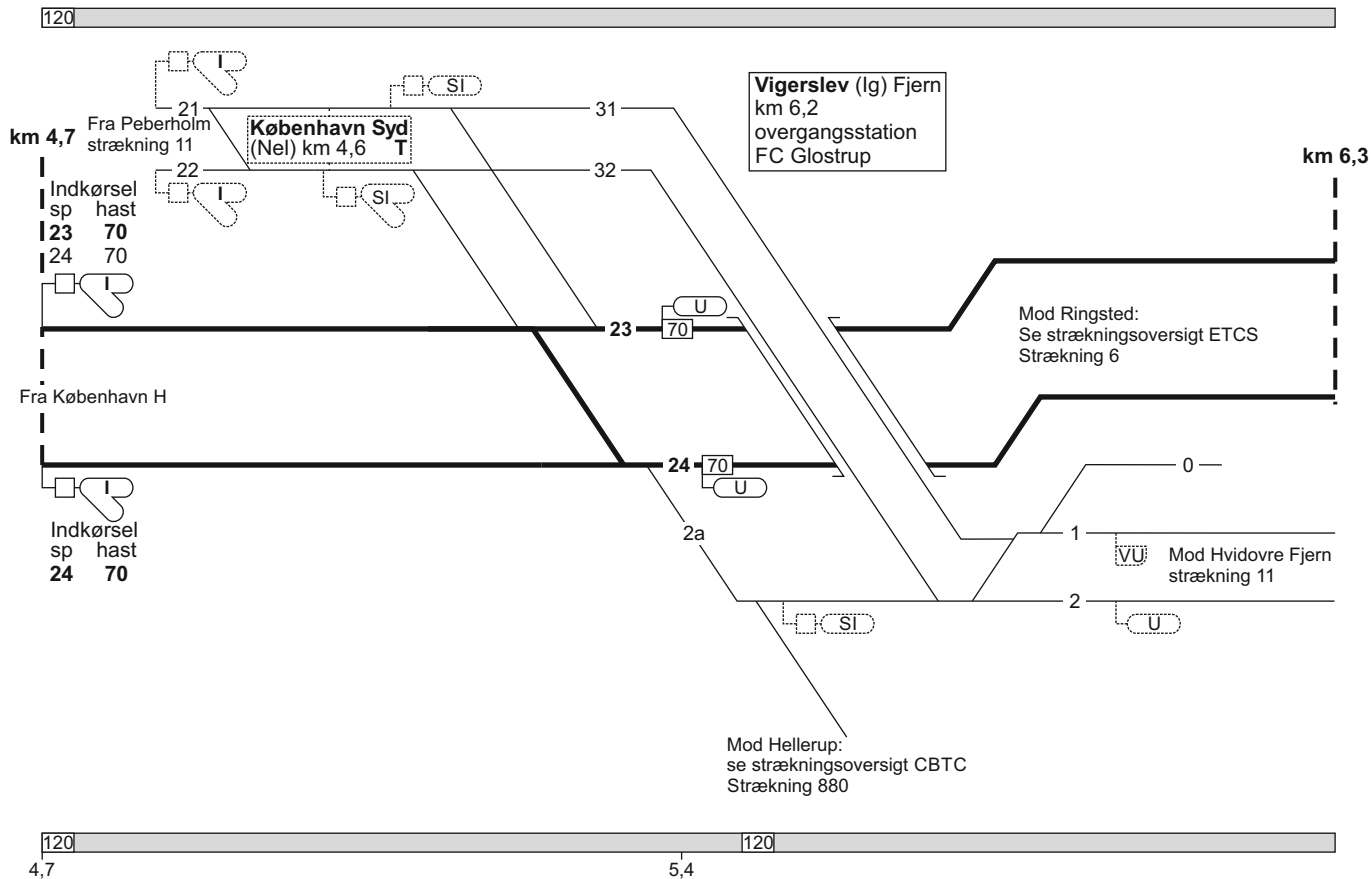

FC Glostrup
linjeblok / vekselspor
stigning C

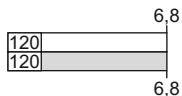

FC Ro Midt
linjeblok / vekselspor
stigning G

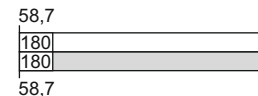

km 6,3

Kilometreringsskift

km 59,2
(km 61,4)

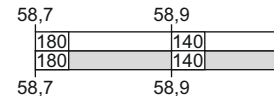
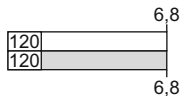
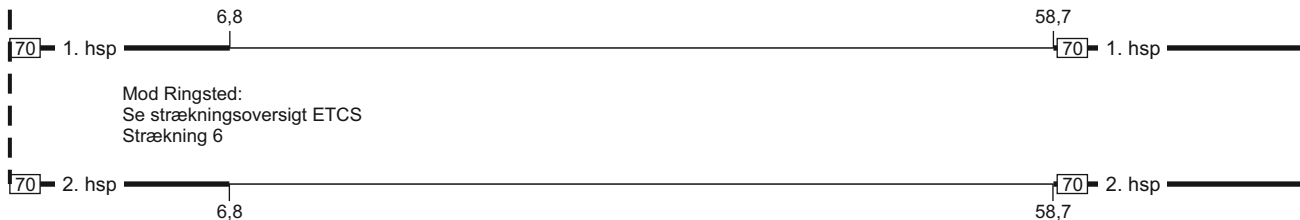

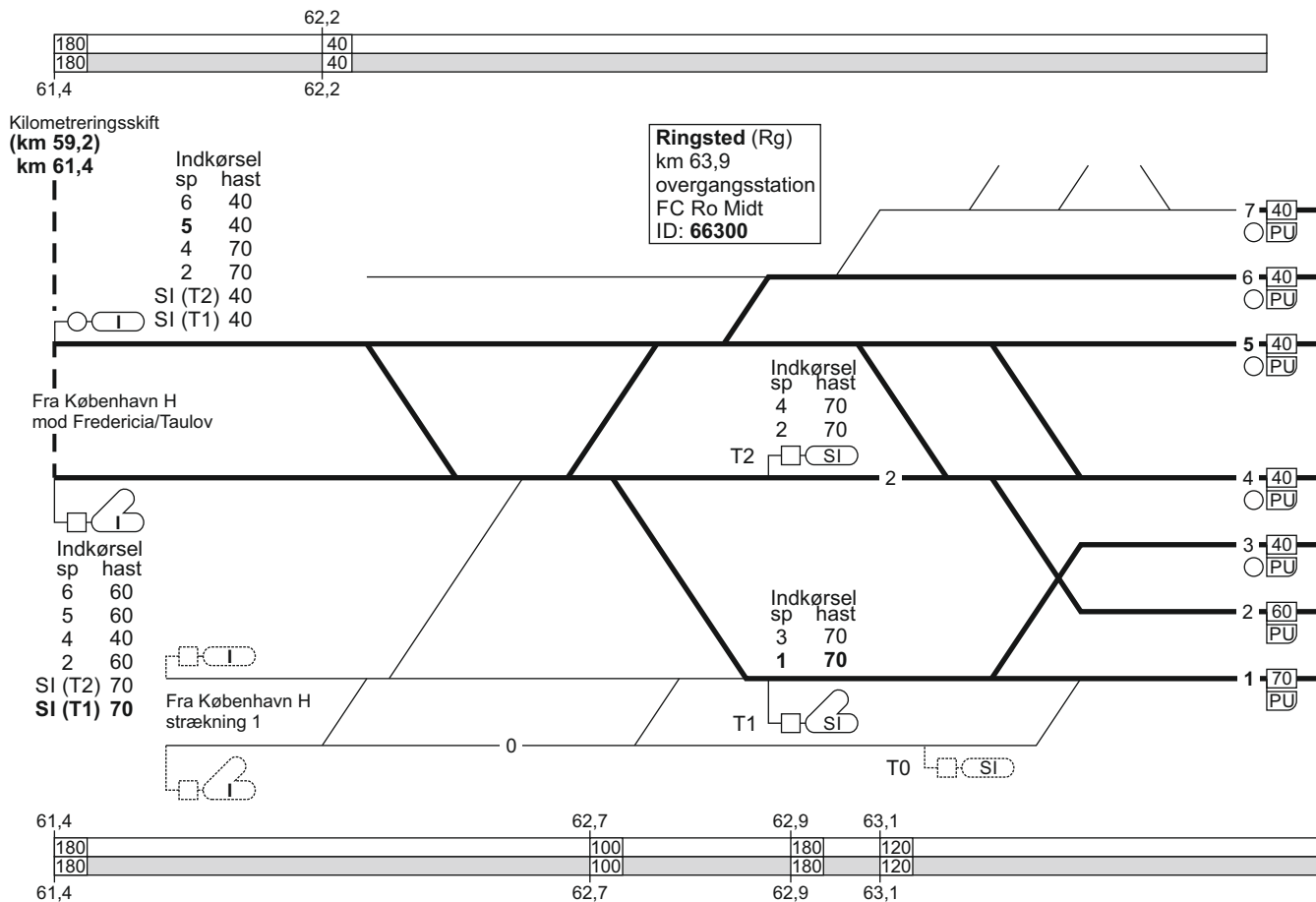

Ringsted (Rg)
 km 63,9
 overgangsstation
 FC Ro Midt
 ID: 66300

120

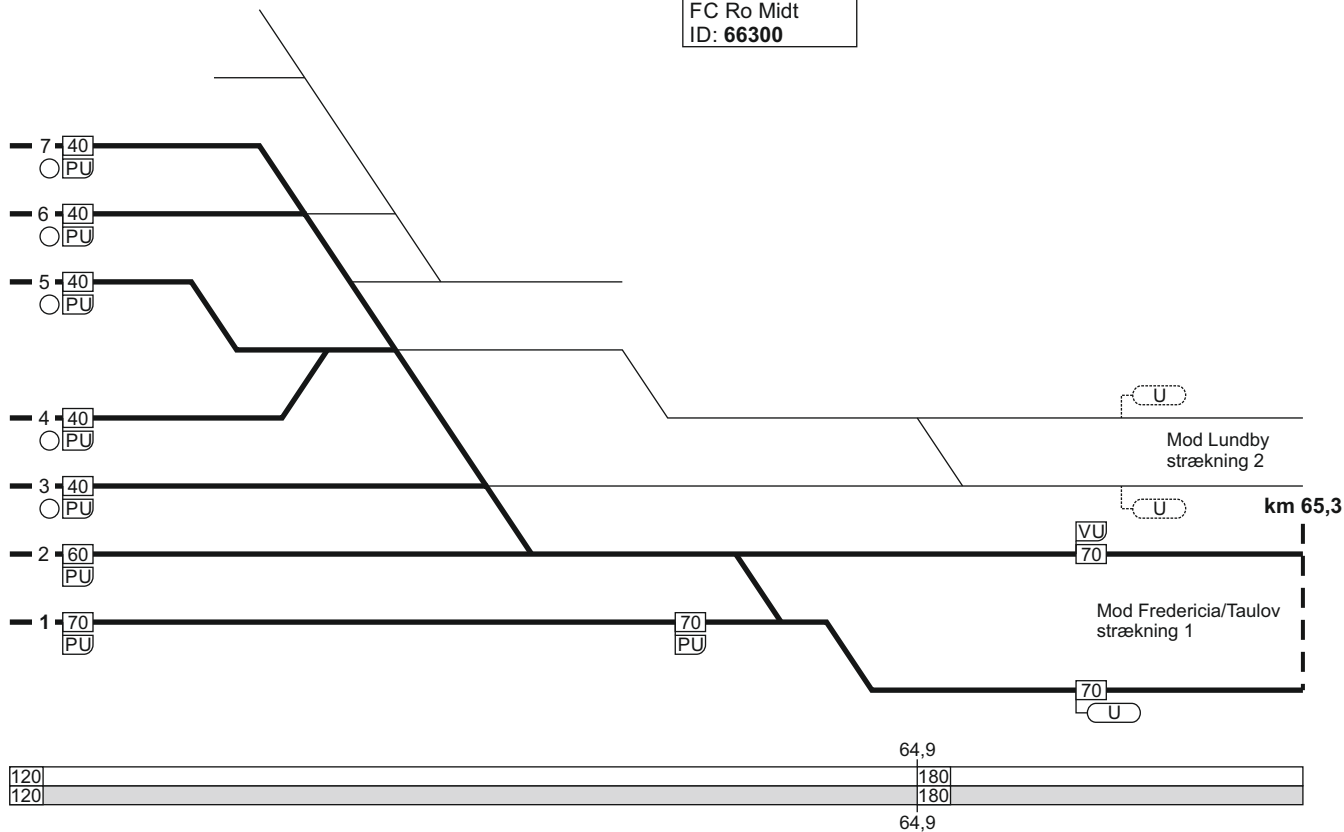

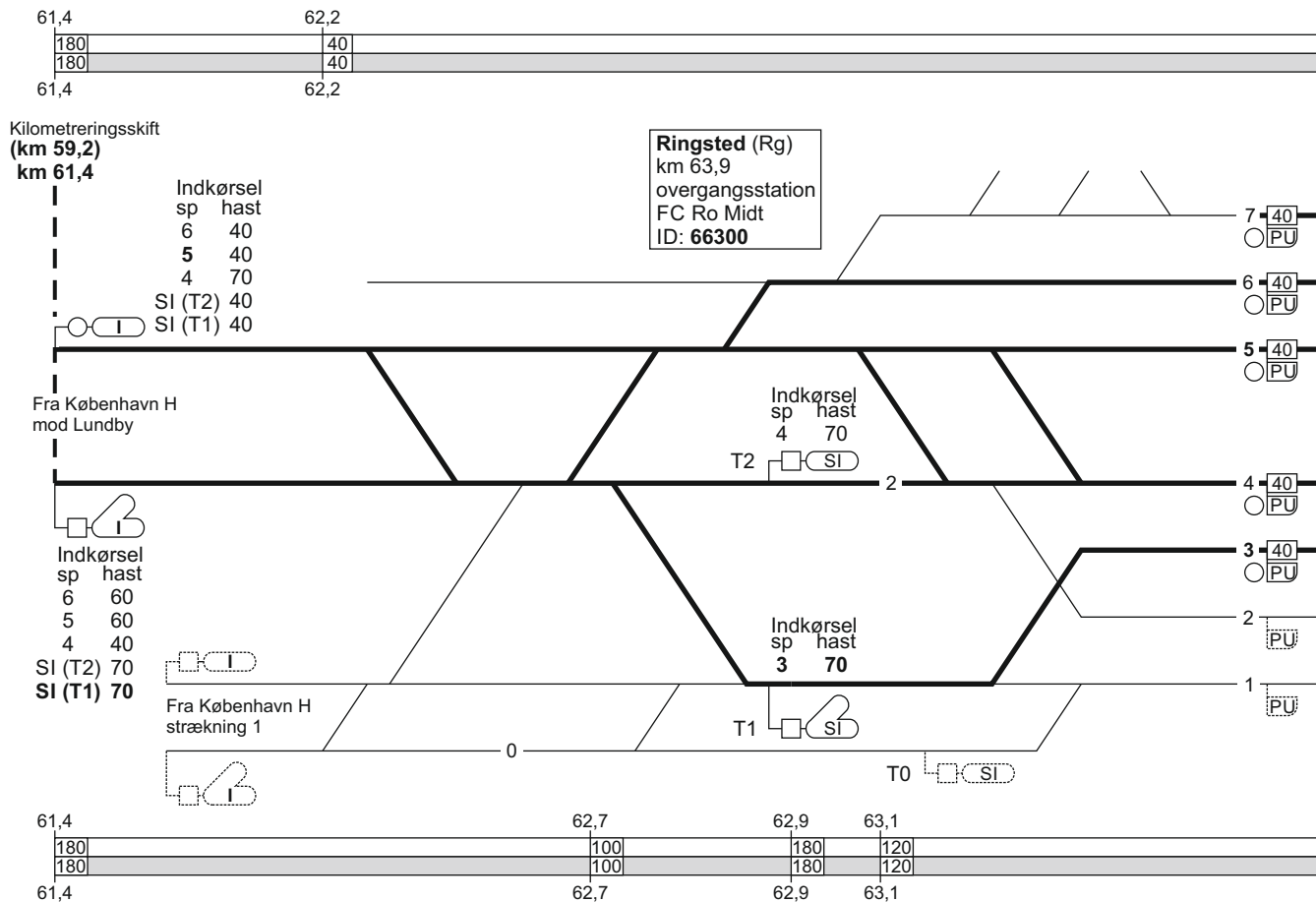

TIB-S 6. København H - Vigerslev - (Avedøre Havnevej) og (Bjæverskov) - Ringsted

130

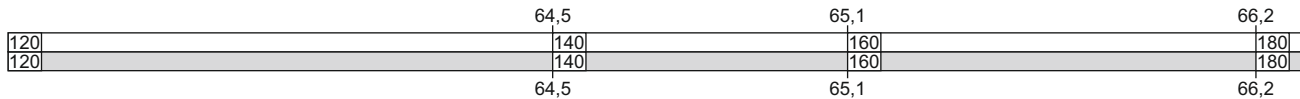
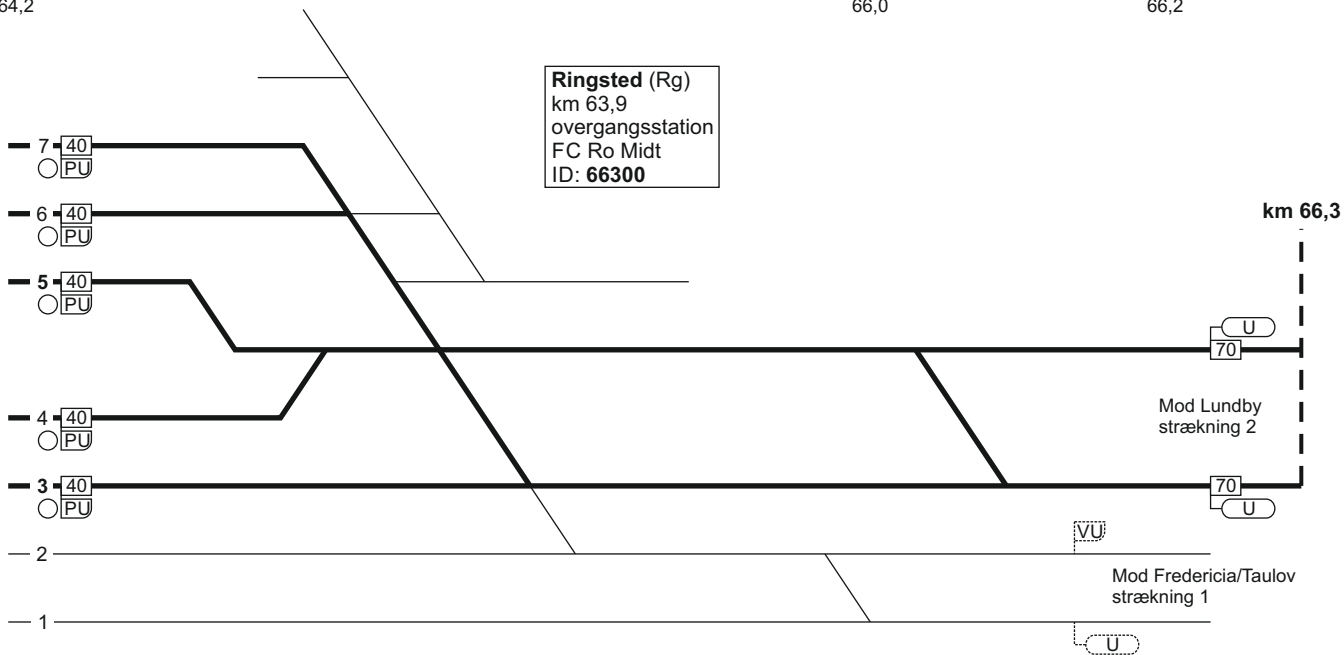
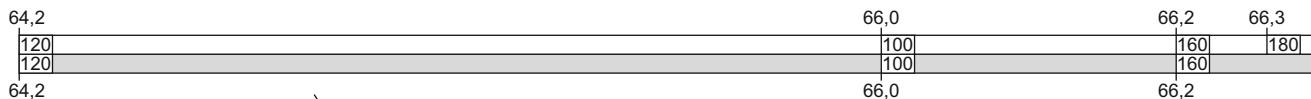

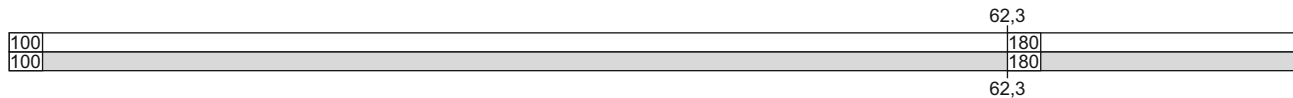
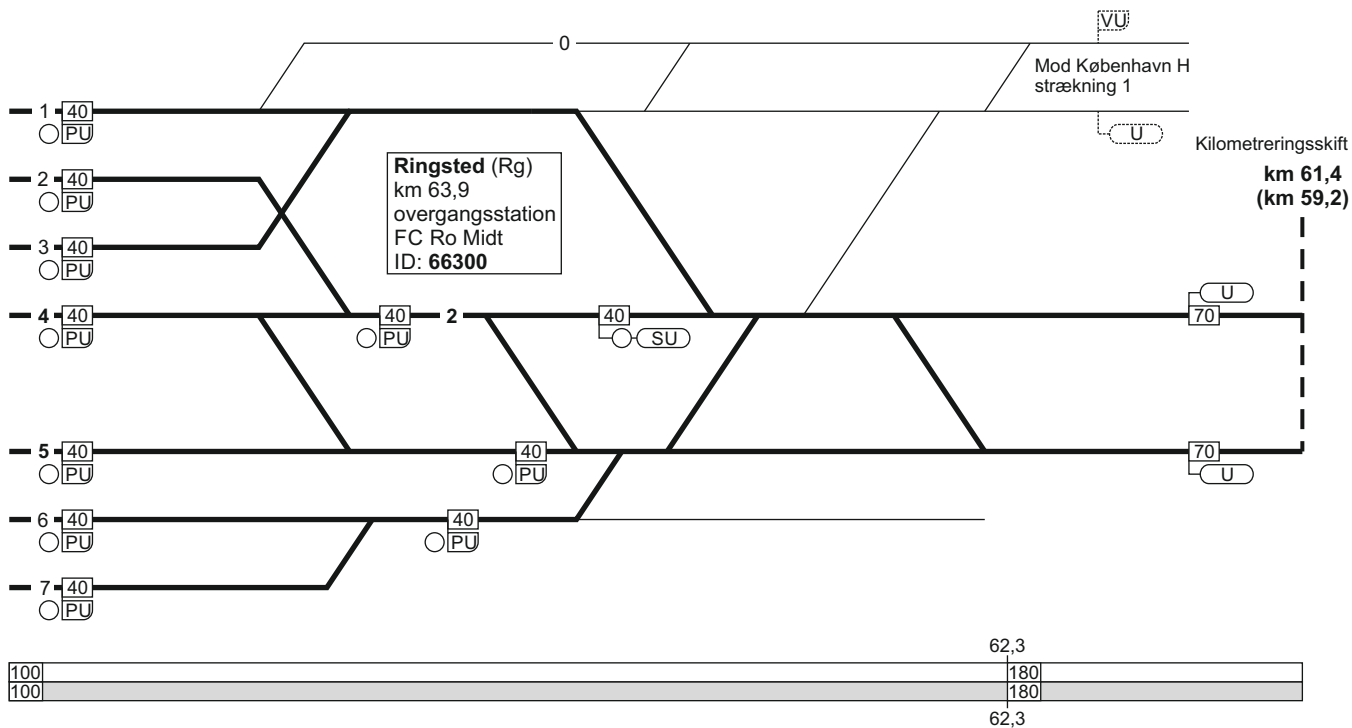
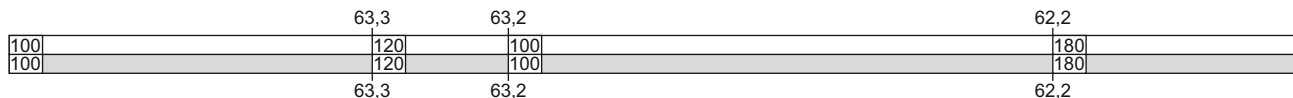

TIB-S 6. Ringsted - (Bjæverskov) og (Avedøre Havnevej) - Vigerslev - København H 132

FC Ro Midt
linjeblok / vekselspor
stigning G

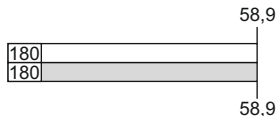

FC Glostrup
linjeblok / vekselspor
stigning C

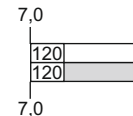

Kilometreringsskift

(km 61,4)
km 59,2

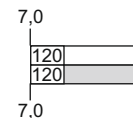
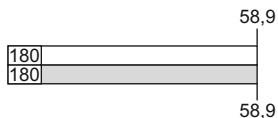
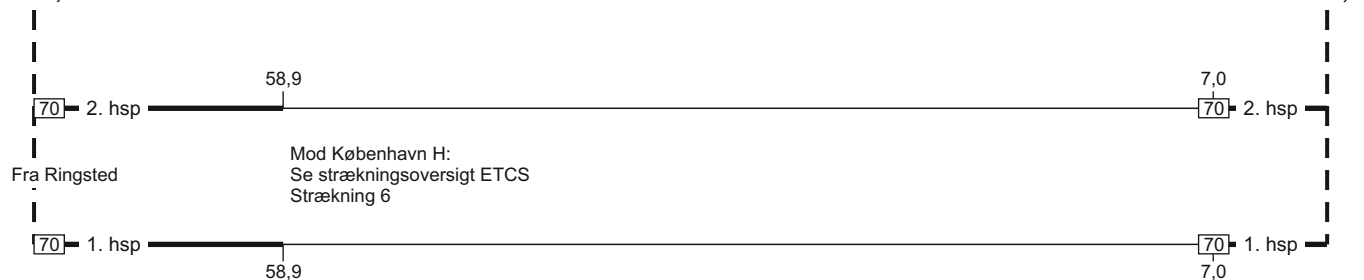

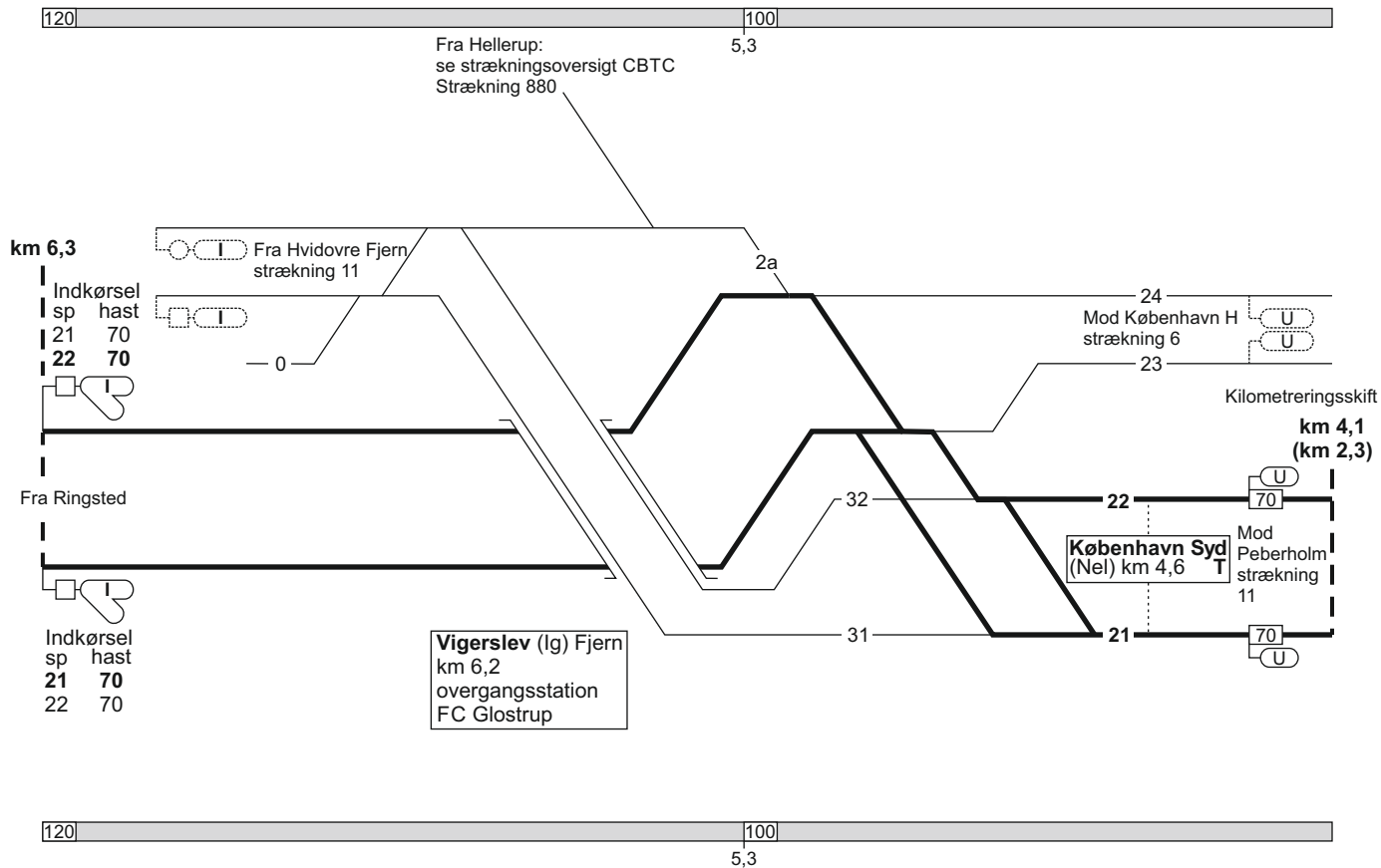

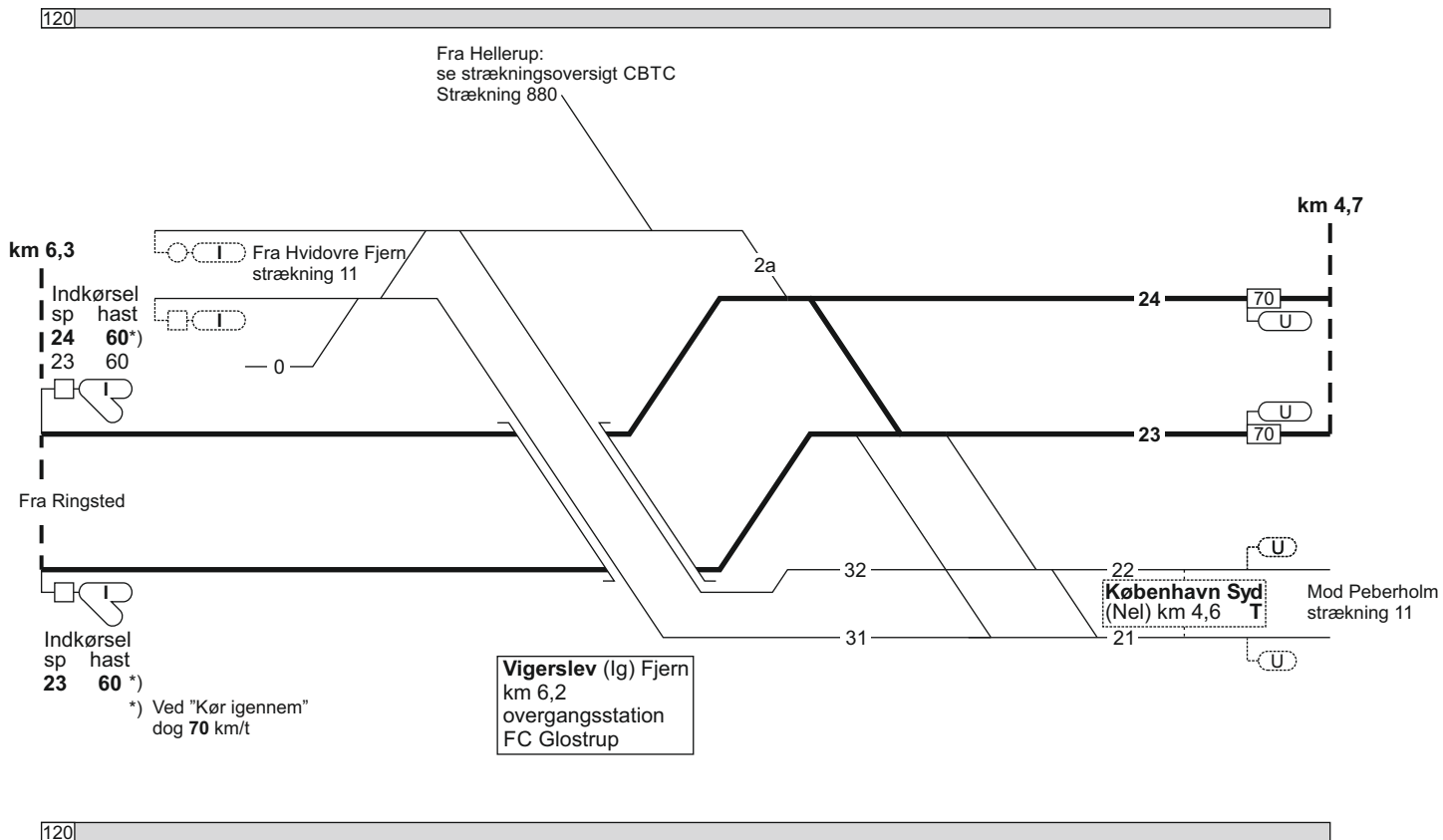

FC Glostrup
linjeblok / vekselspor
stigning G

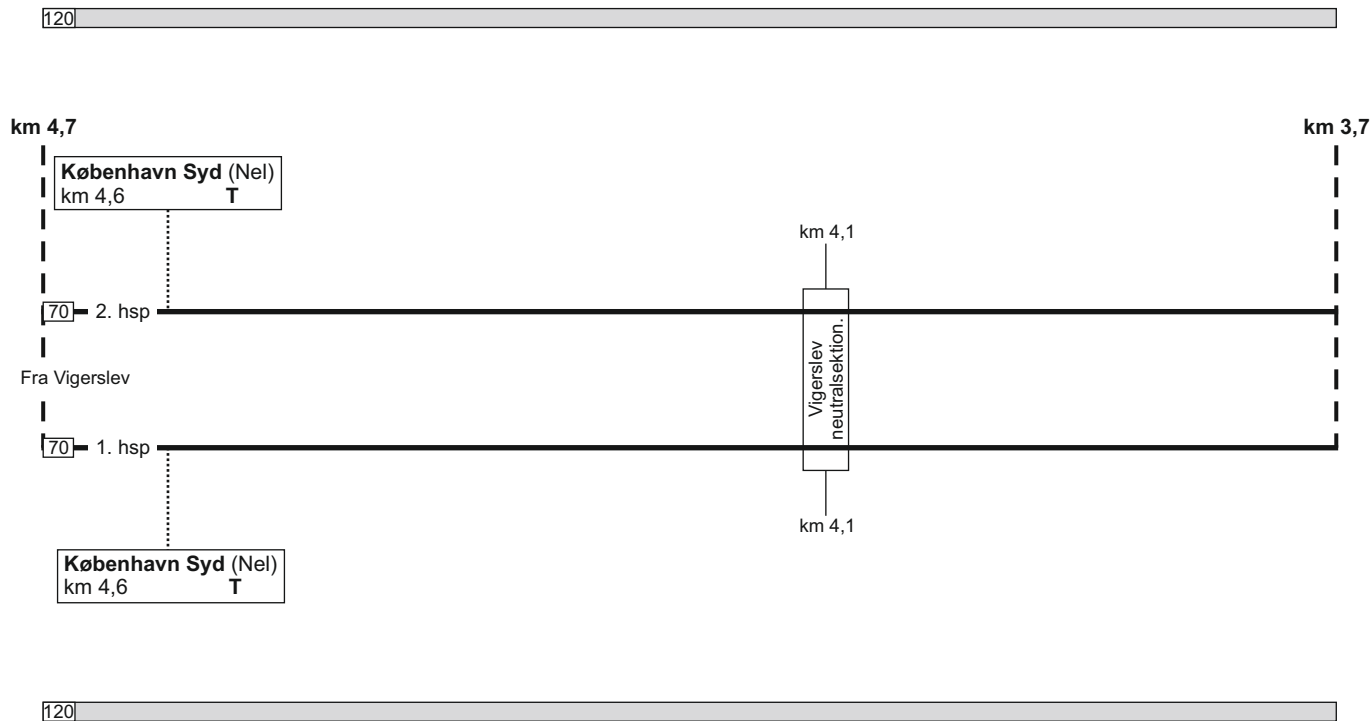

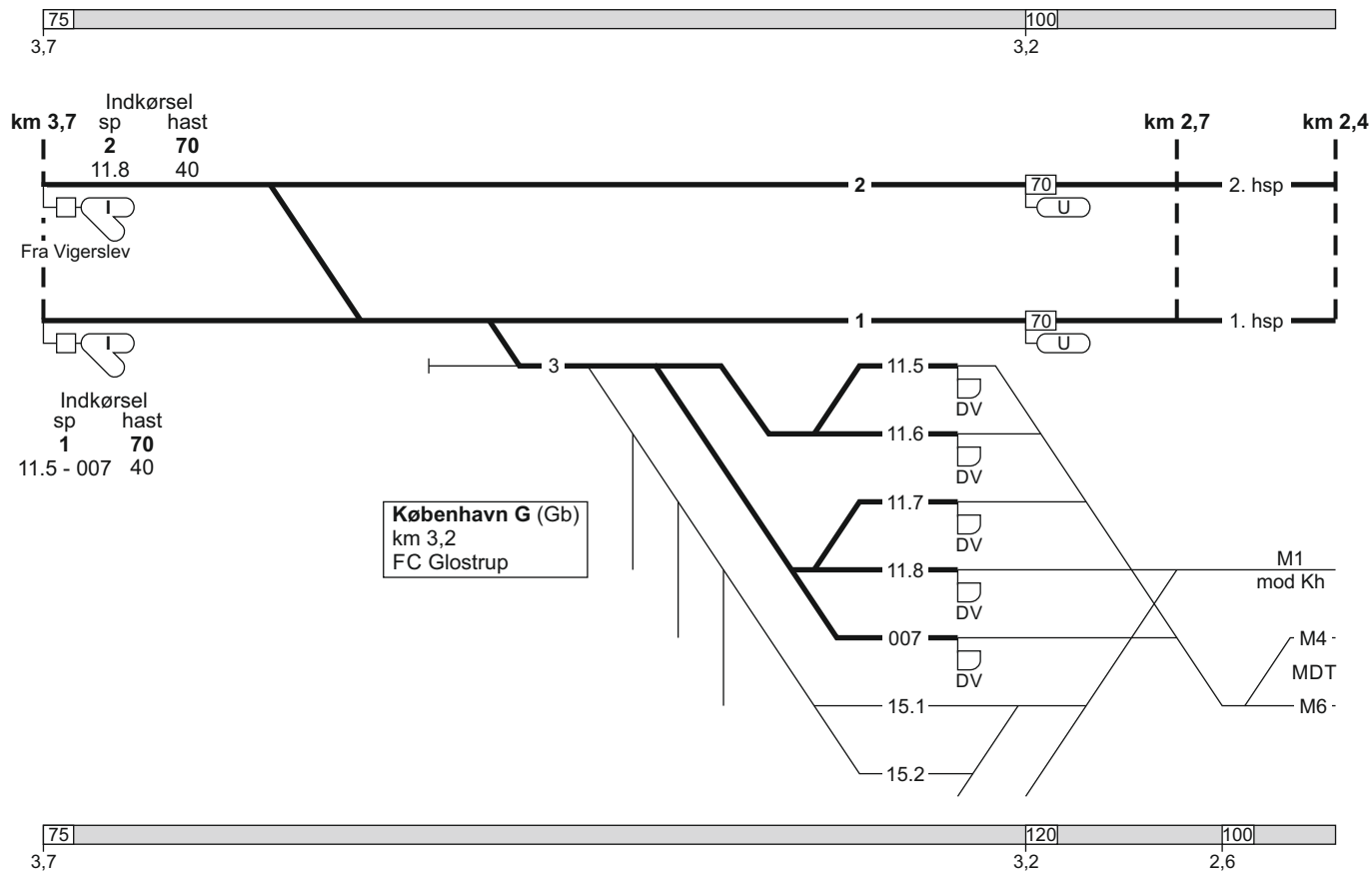

Togekspeditionssted 1	Togfølgestation 2	Sporbenyttelse 3	Standingssted 4	Kmp/FC telefonnummer 5
København H				Kmp: 82 34 12 14 eller 82 42 26 12 GSM-R: 81 99 12 00 FC Glostrup: Kh (ekskl.) - lg 82 34 18 80 GSM-R: 81 99 12 01
København G				GSM-R: 81 99 12 07

Togekspeditionssted 1	Togfølgestation 2	Sporbenyttelse 3	Standsningssted 4	Kmp/FC telefonnummer 5
Ringsted				FC Roskilde Midt: 46 32 49 80 eller 82 42 43 11 GSM-R: 81 99 12 09

7. (Svanemøllen) - Østerport**Strækningshastighed:**

Delstrækning	Strækningshastighed (km/t)
(Svanemøllen) - Østerport	40

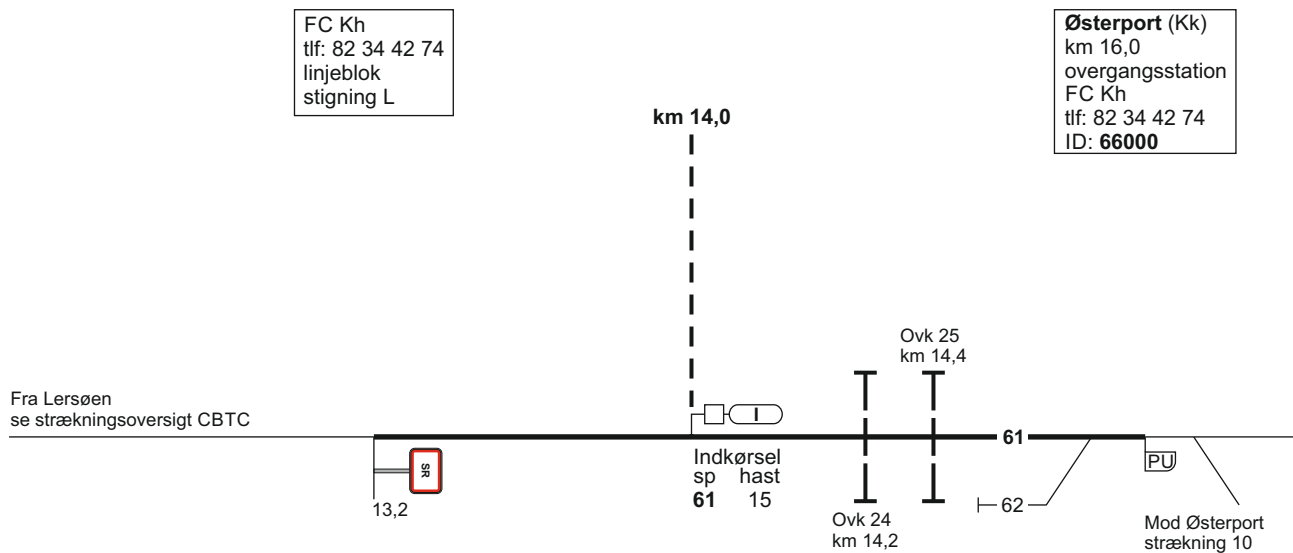

Østerport (Kk)
km 16,0
overgangsstation
FC Kh
tlf: 82 34 42 74
ID: **66000**

FC Kh
tlf: 82 34 42 74
linjeblok
stigning E

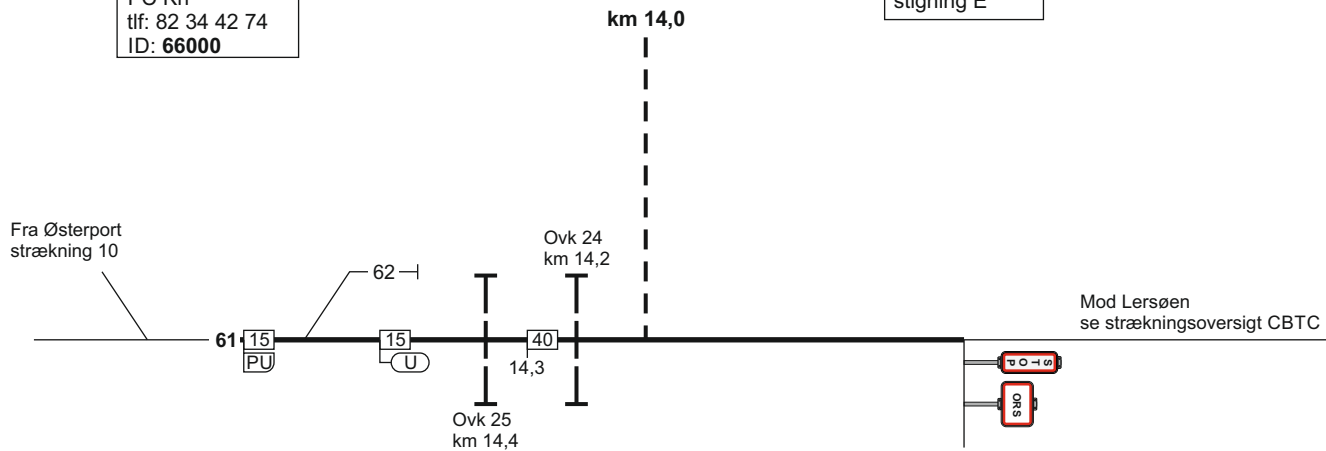

Togekspeditionssted 1	Togfølgestation 2	Sporbenyttelse 3	Standsningssted 4	Kh/FC telefonnummer
Østerport				82 34 42 74

10. København - Helsingør**Strækningshastighed:**

Delstrækning	Strækningshastighed (km/t)
København H - Helsingør	120

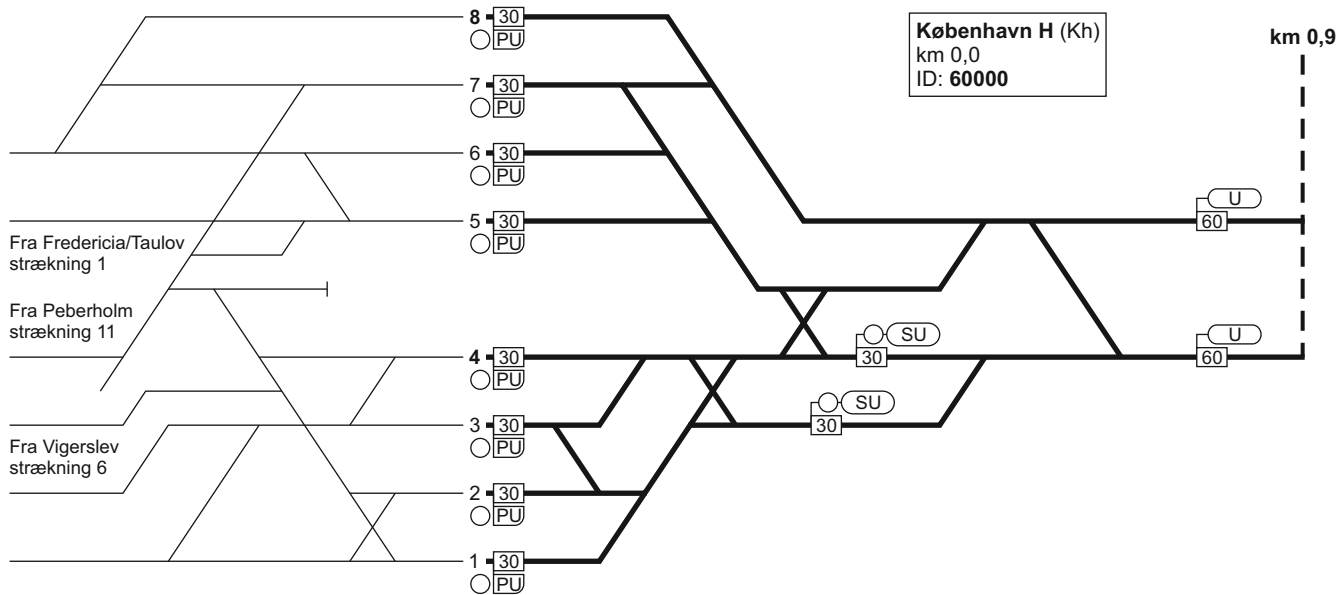
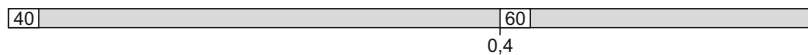

FC Østerport
linjeblok / vekselspor
stigning L

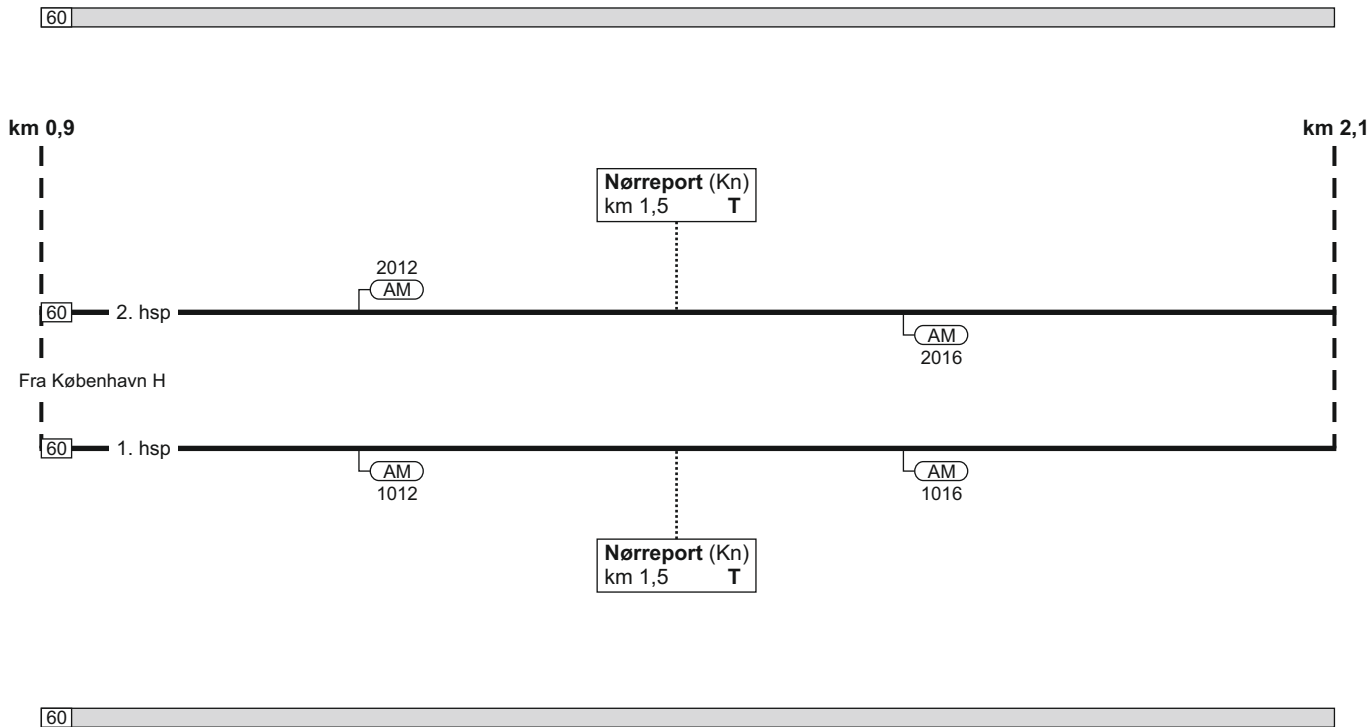

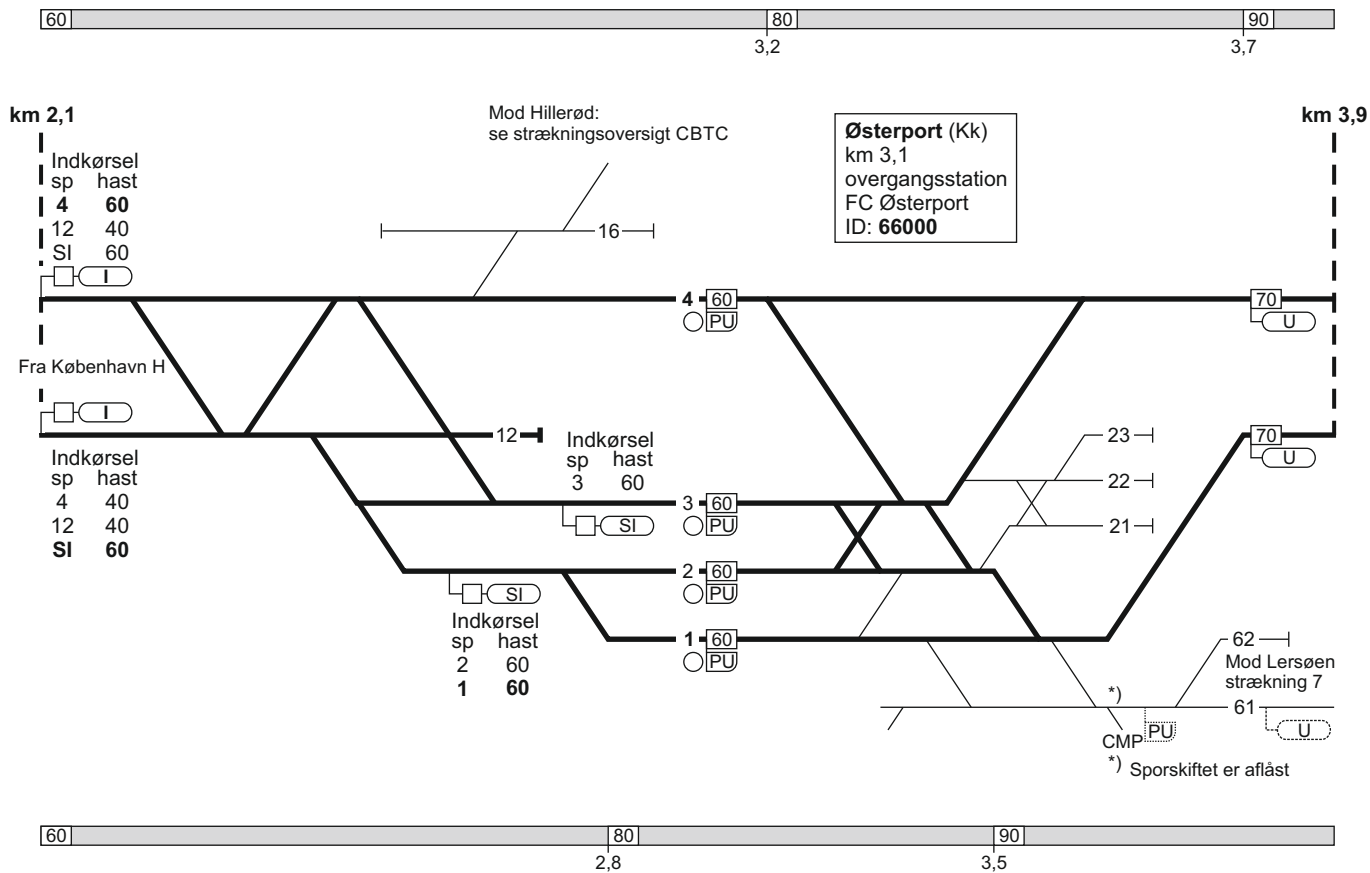

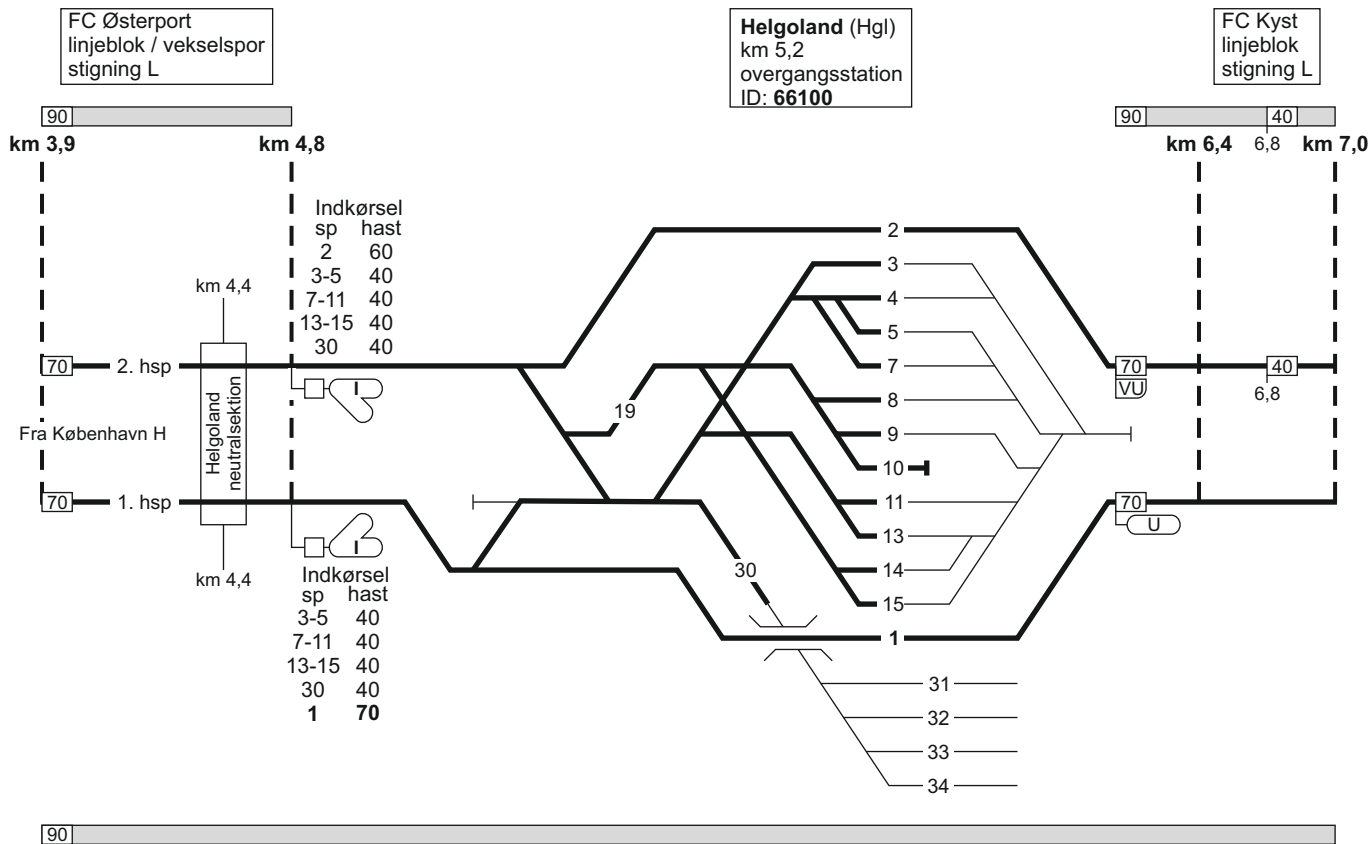

Hellerup (HI)
 km 7,8
 overgangsstation
 FC Kyst

100

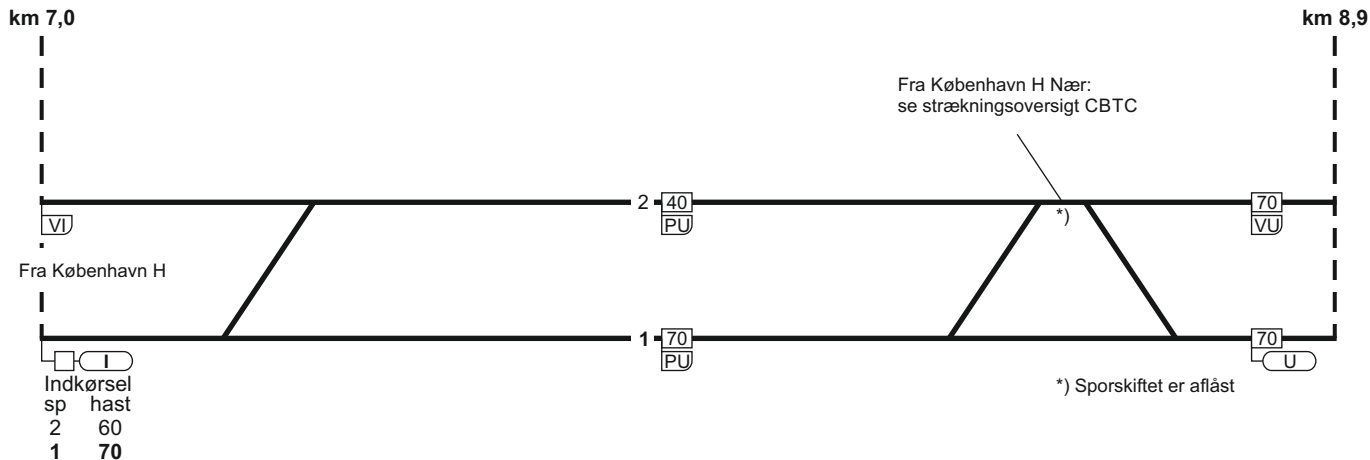

90

100

8,5

FC Kyst
linjeblok
stigning L

Klampenborg (KI)
km 13,3
FC Kyst

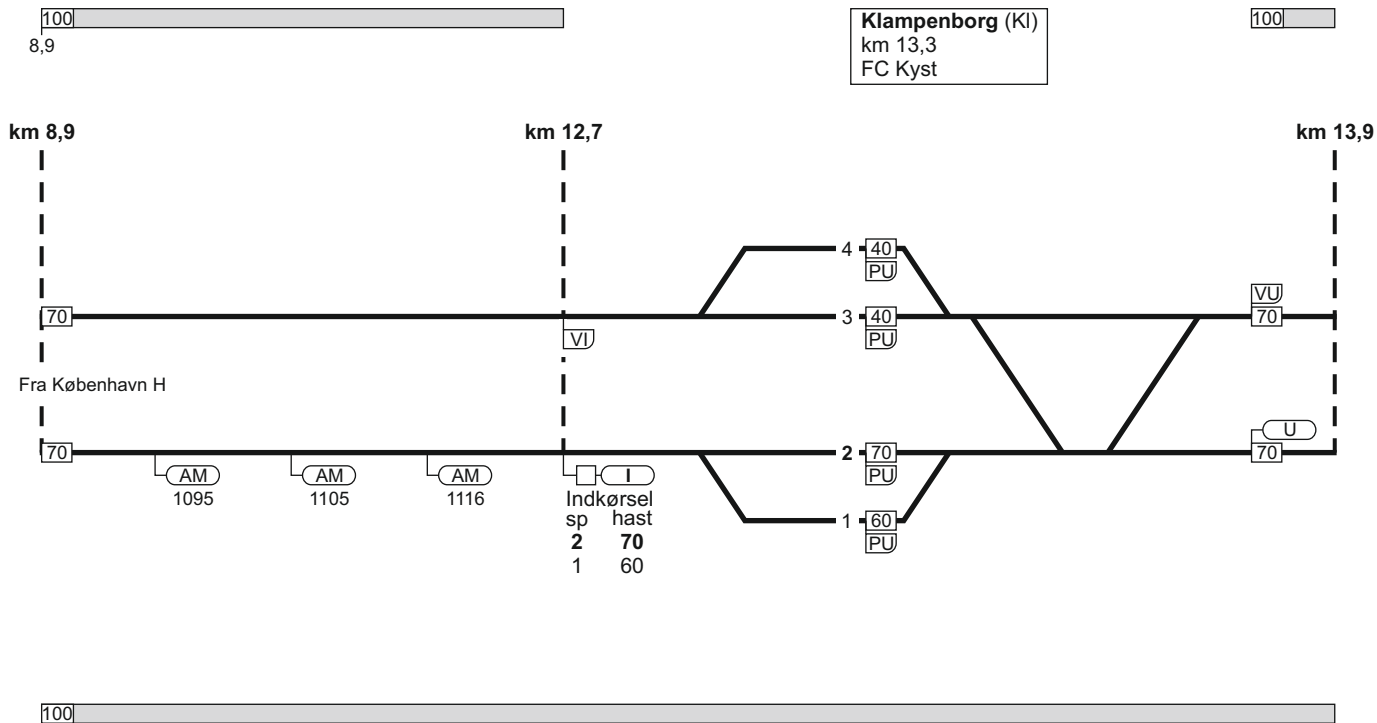

FC Kyst
linjeblok
stigning H

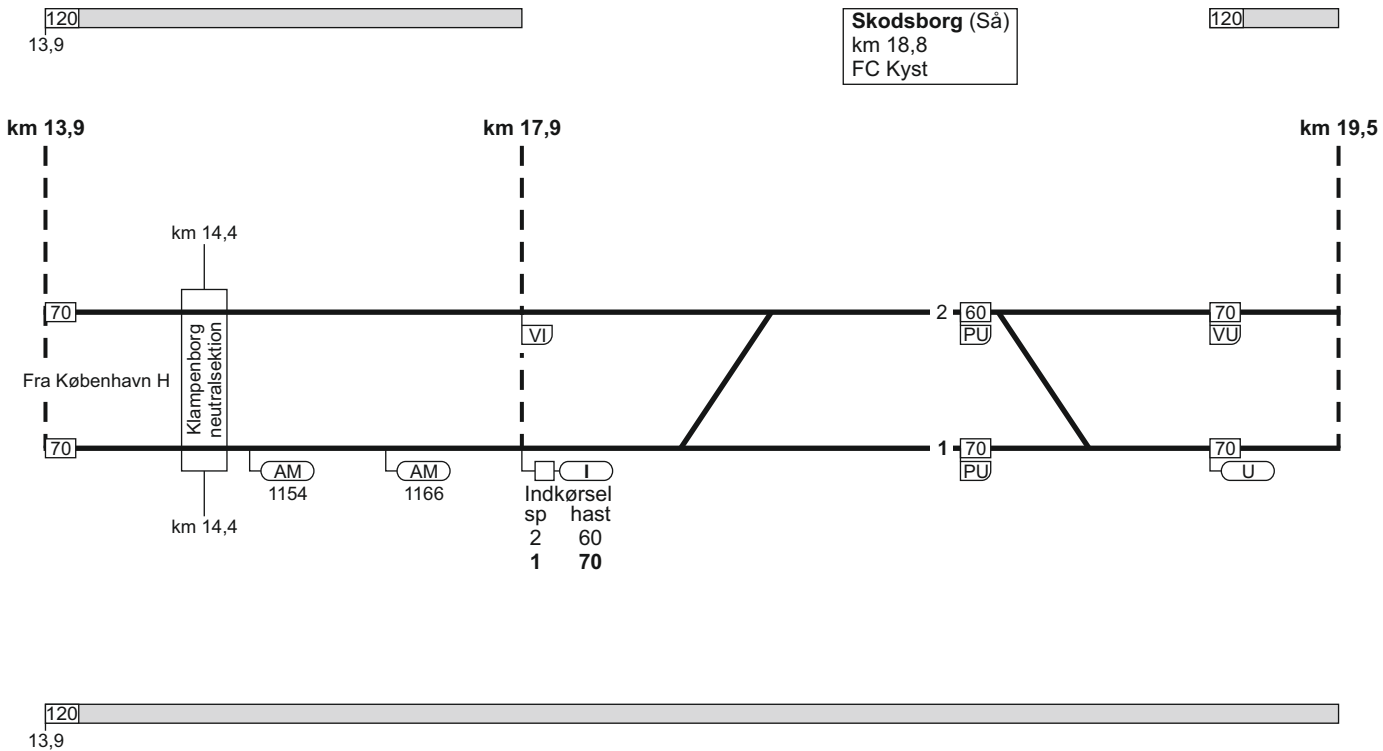

FC Kyst
linjeblok
stigning J

Nivå (Ni)
km 32,5
FC Kyst

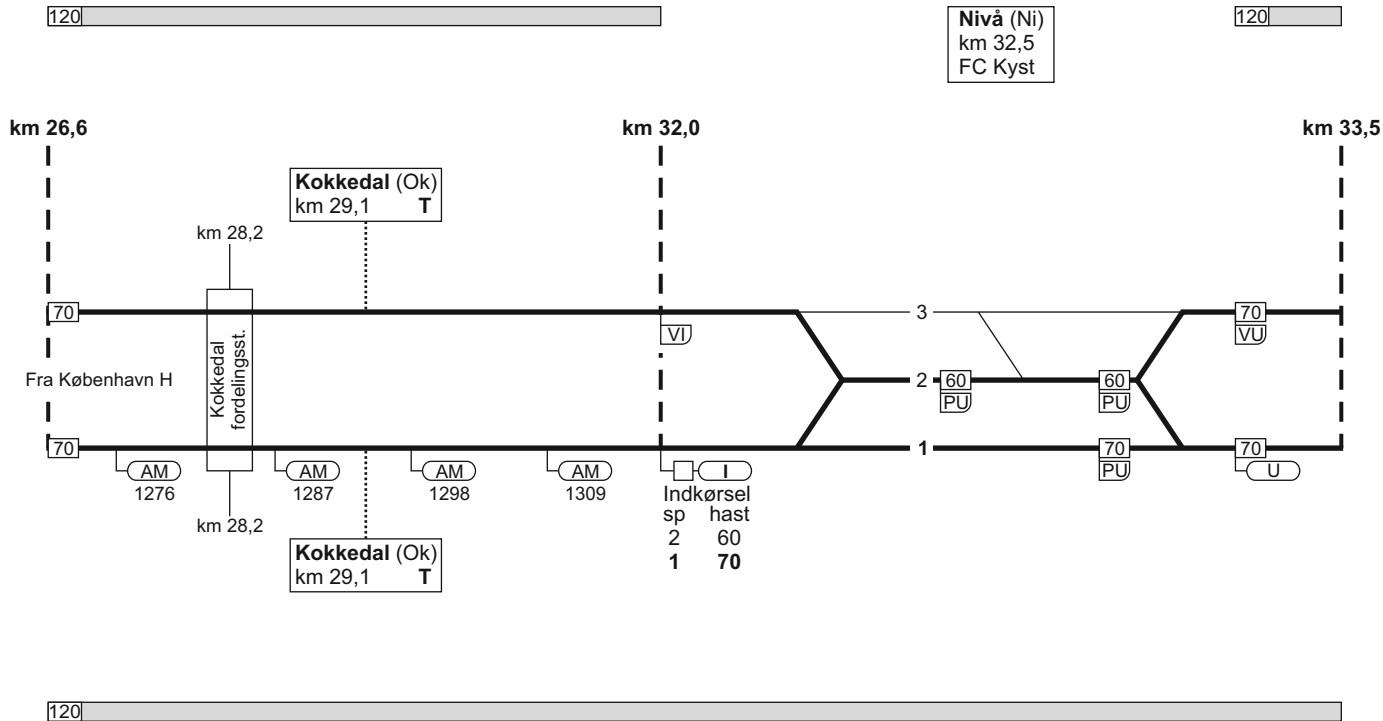

FC Kyst
linjeblok
stigning H

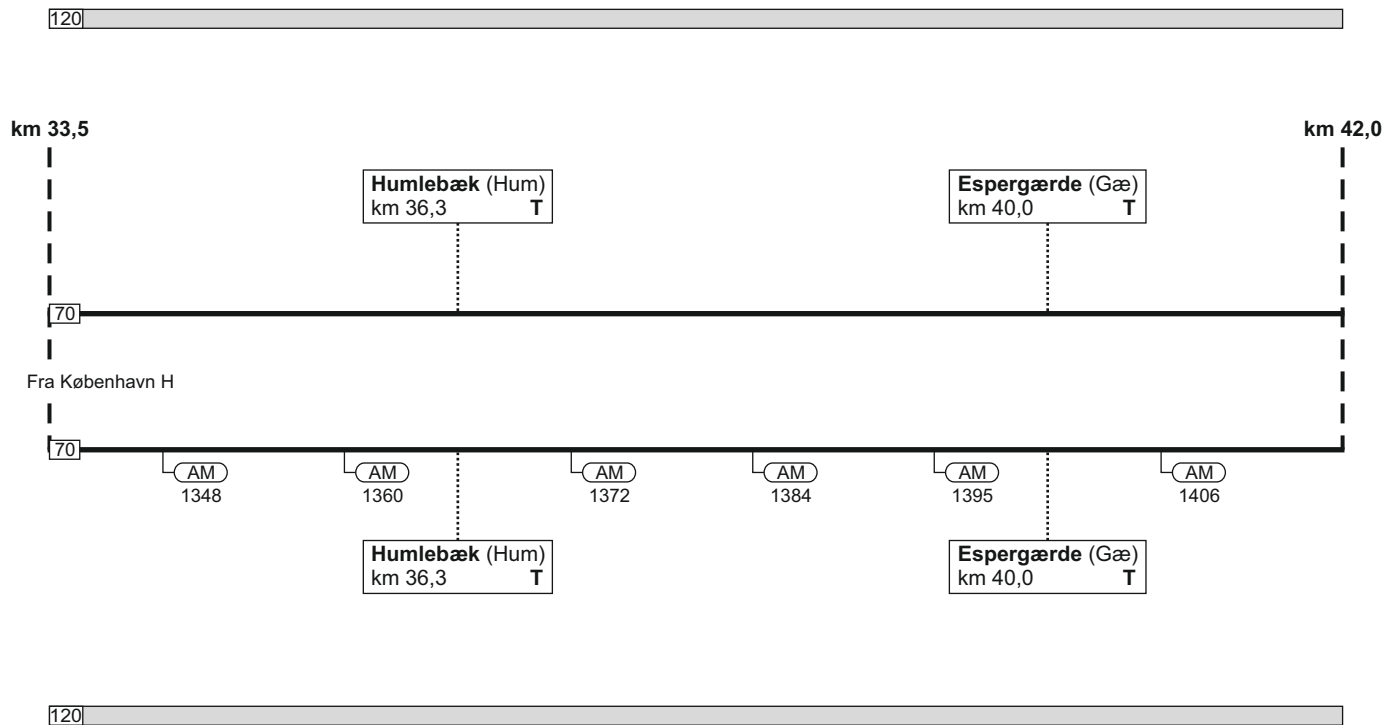

FC Kyst
linjeblok (kun højre spor)
stigning M

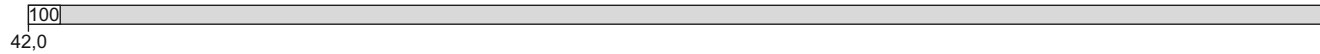
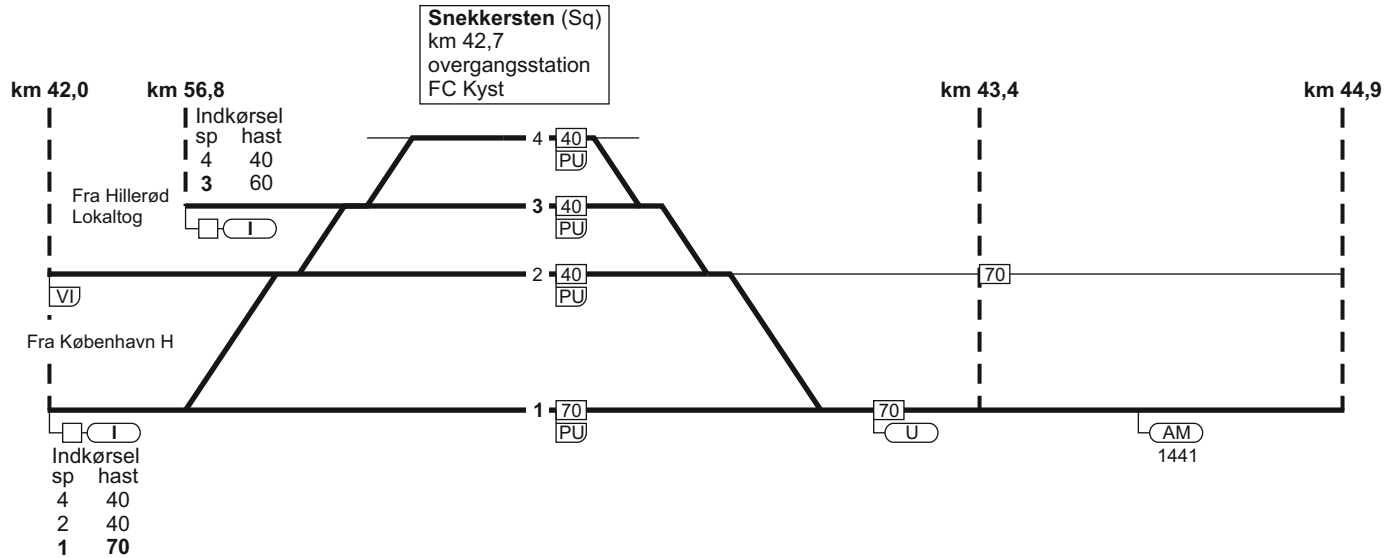

Helsingør (Hg)
 km 46,2
 overgangsstation
 ID: 66200

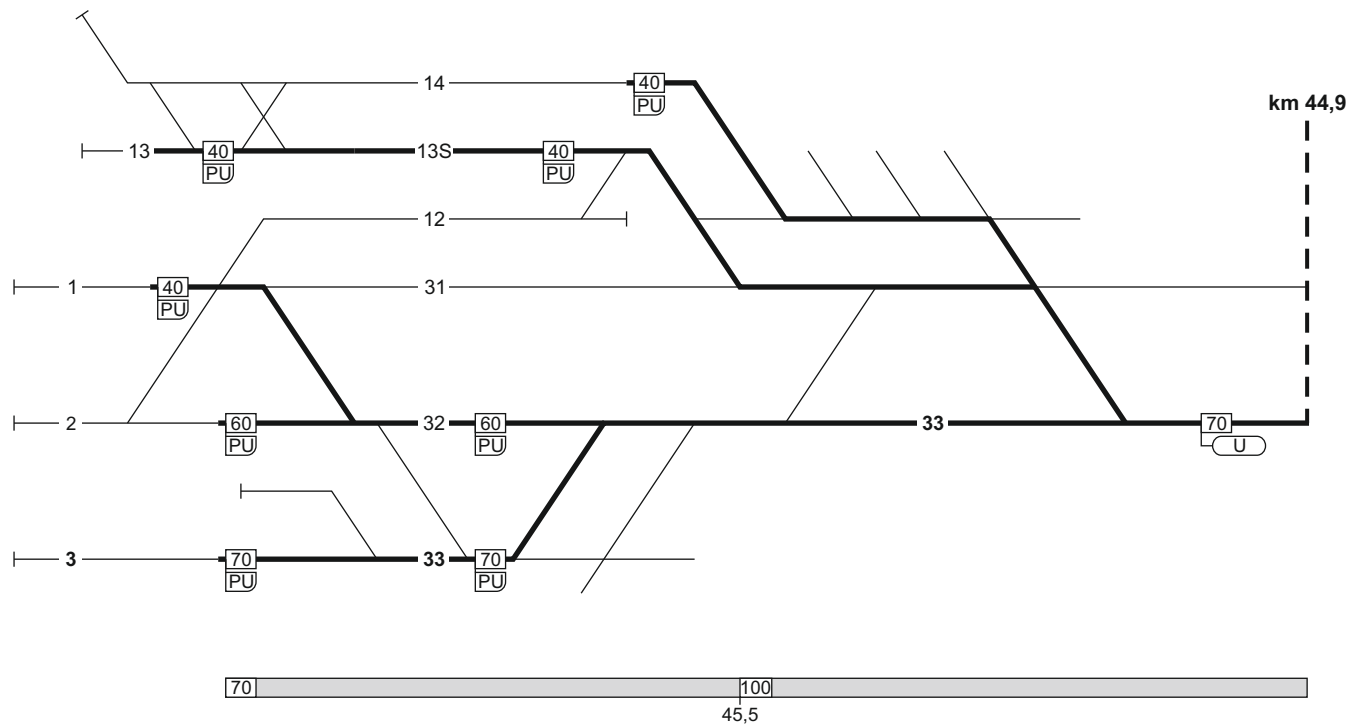

FC Kyst
linjeblok (kun højre spor)
stigning H

Snekkersten (Sq)
km 42,7
overgangsstation
FC Kyst

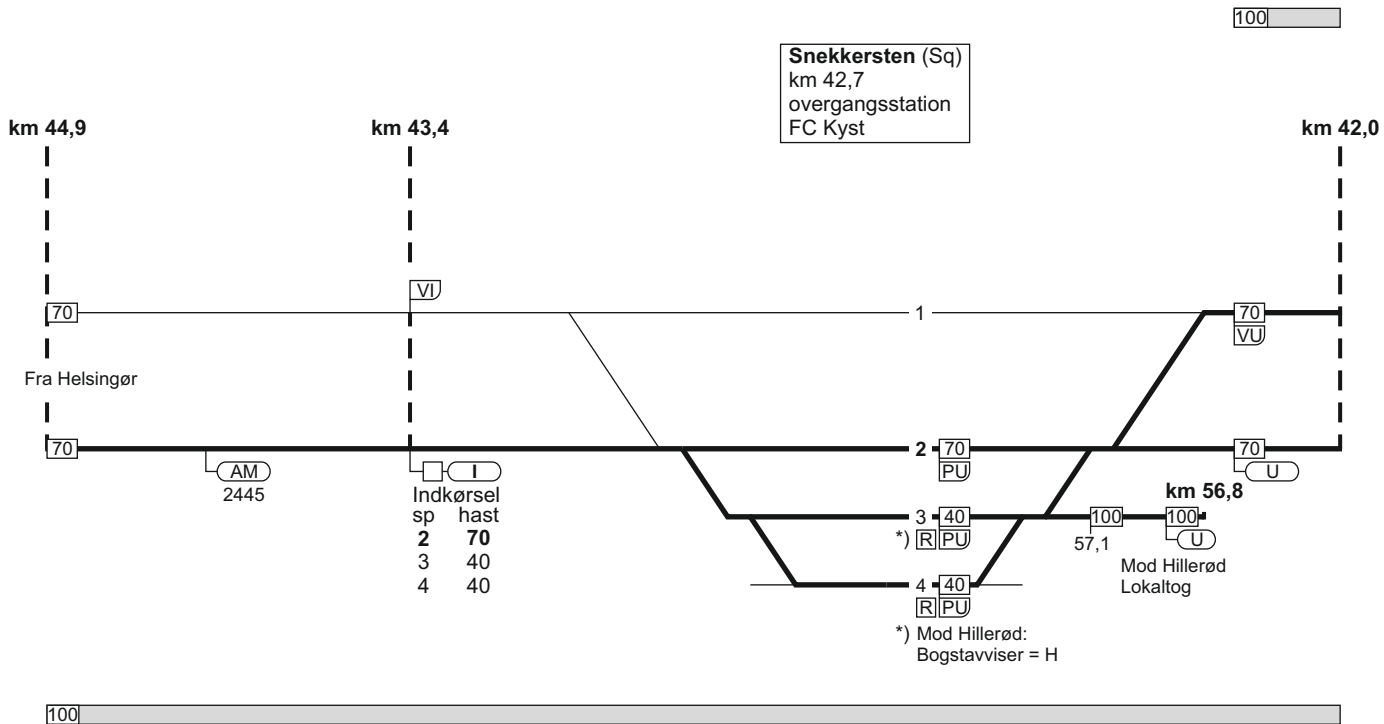

FC Kyst
linjeblok
stigning J

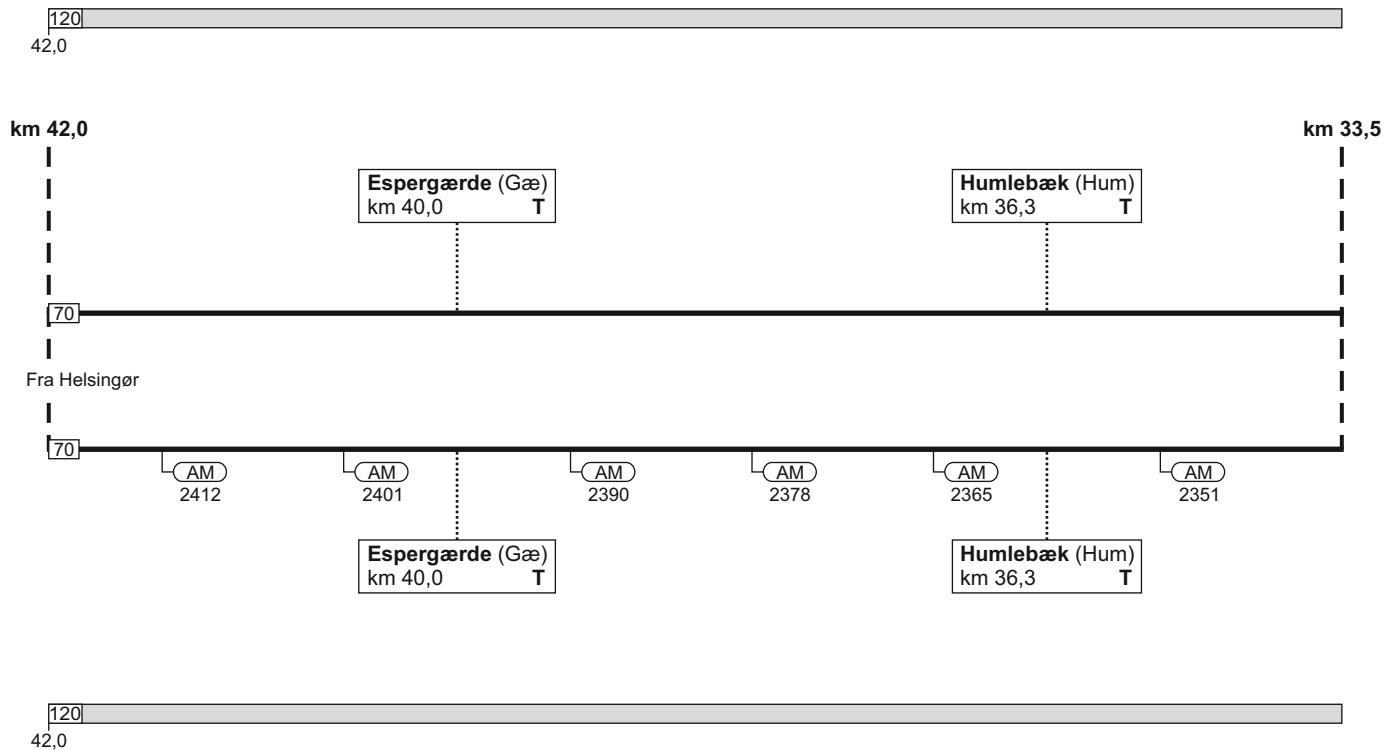

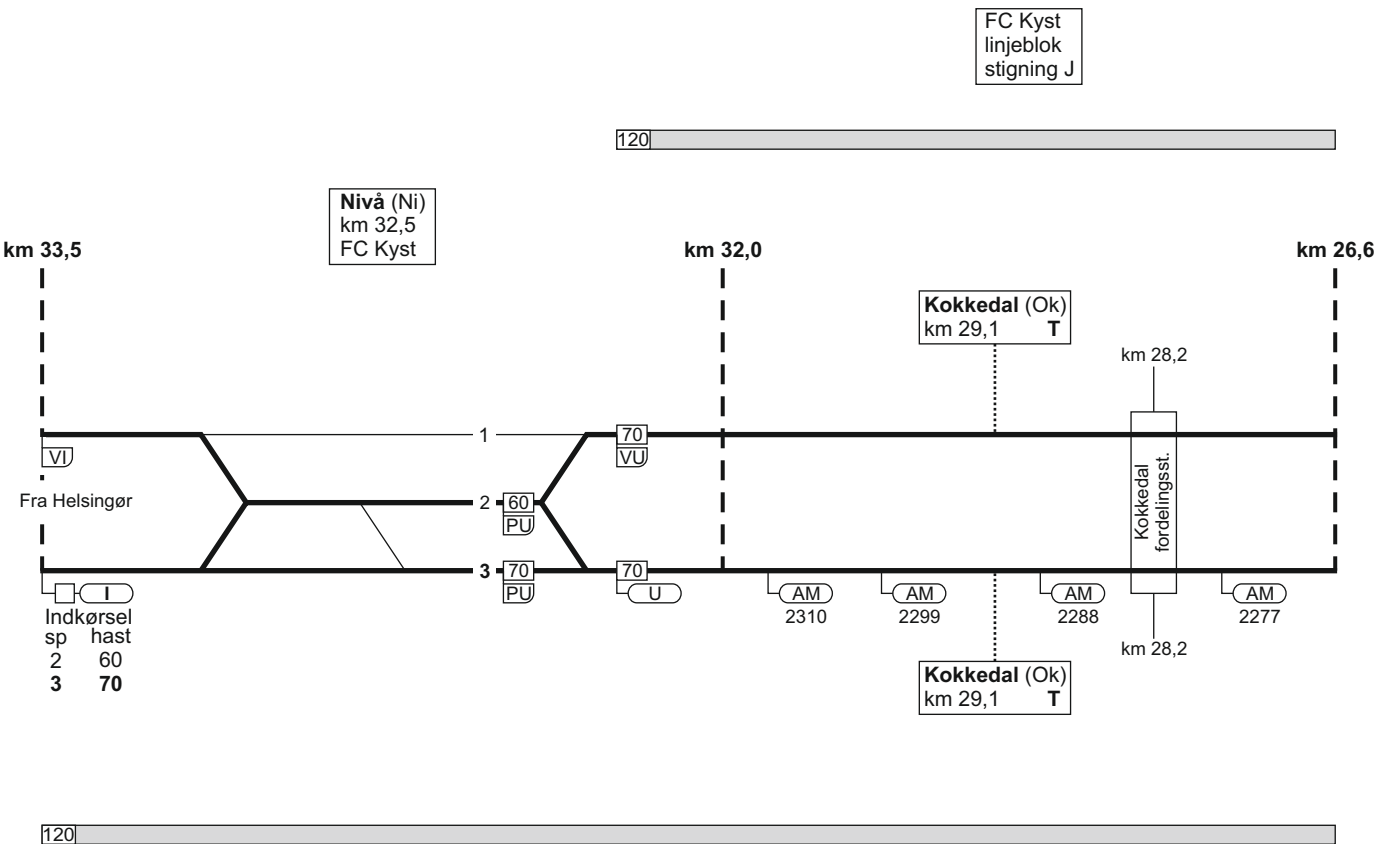

FC Kyst
linjeblok
stigning H

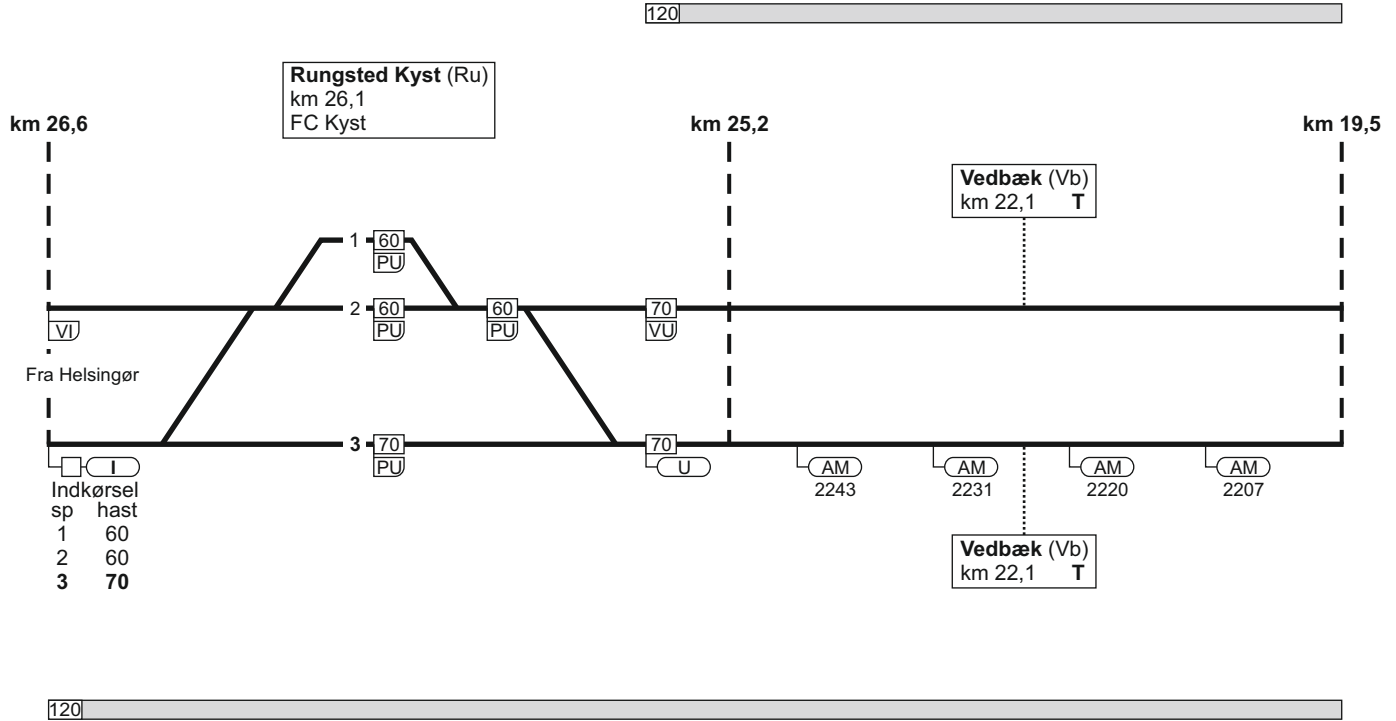

FC Kyst
linjeblok
stigning H

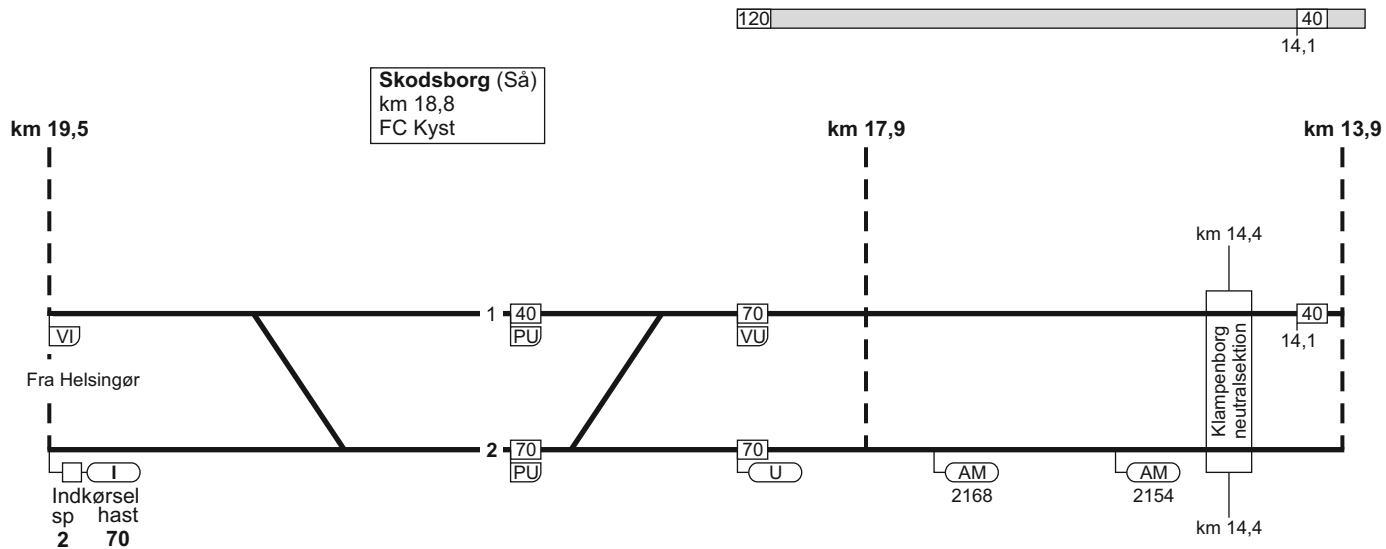

FC Kyst
linjeblok
stigning K

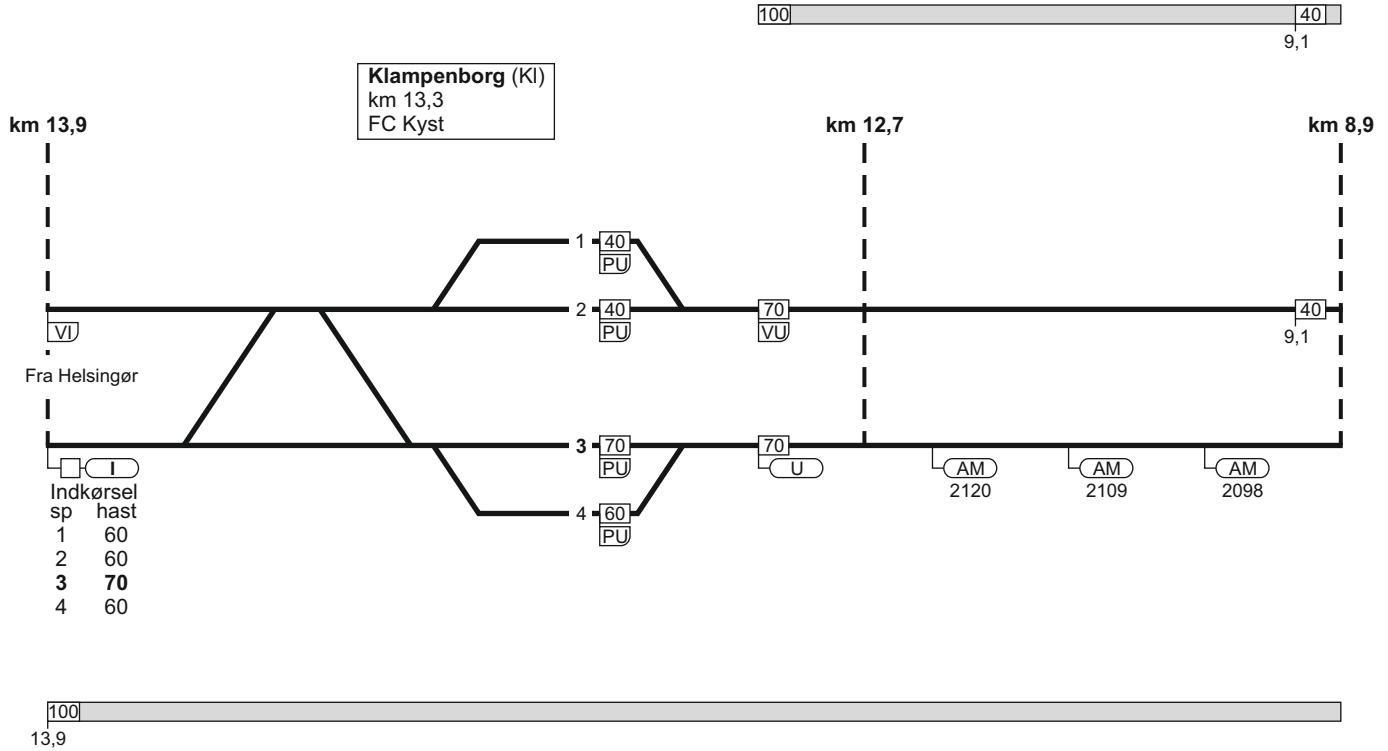

90

Hellerup (HI)
 km 7,8
 overgangsstation
 FC Kyst

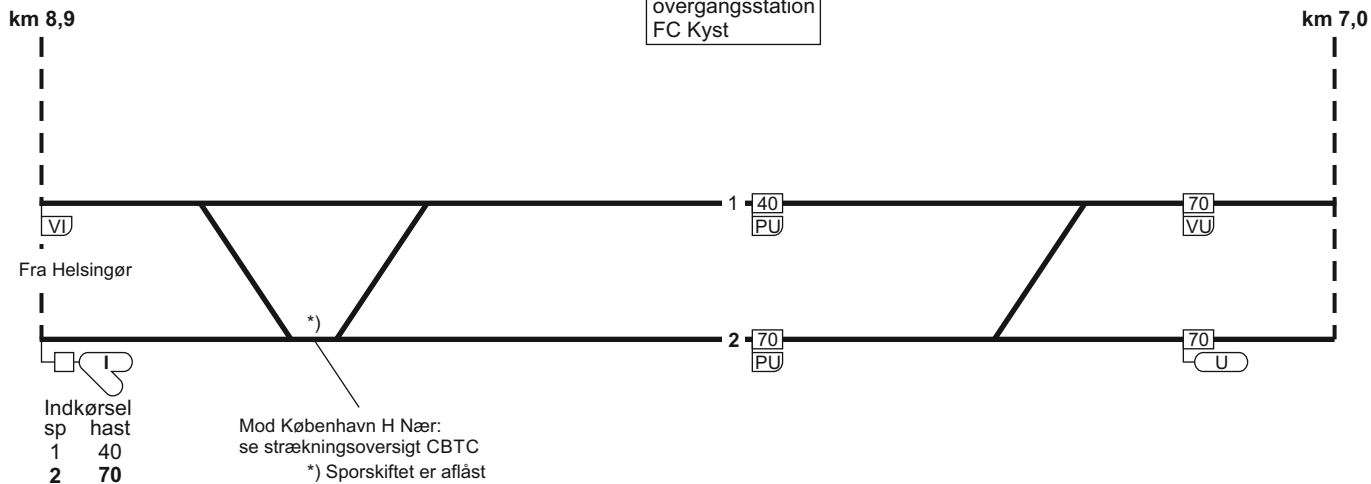

100 90

8,5

FC Kyst
linjeblok
stigning H

FC Østerport
linjeblok / vekselspor
stigning H

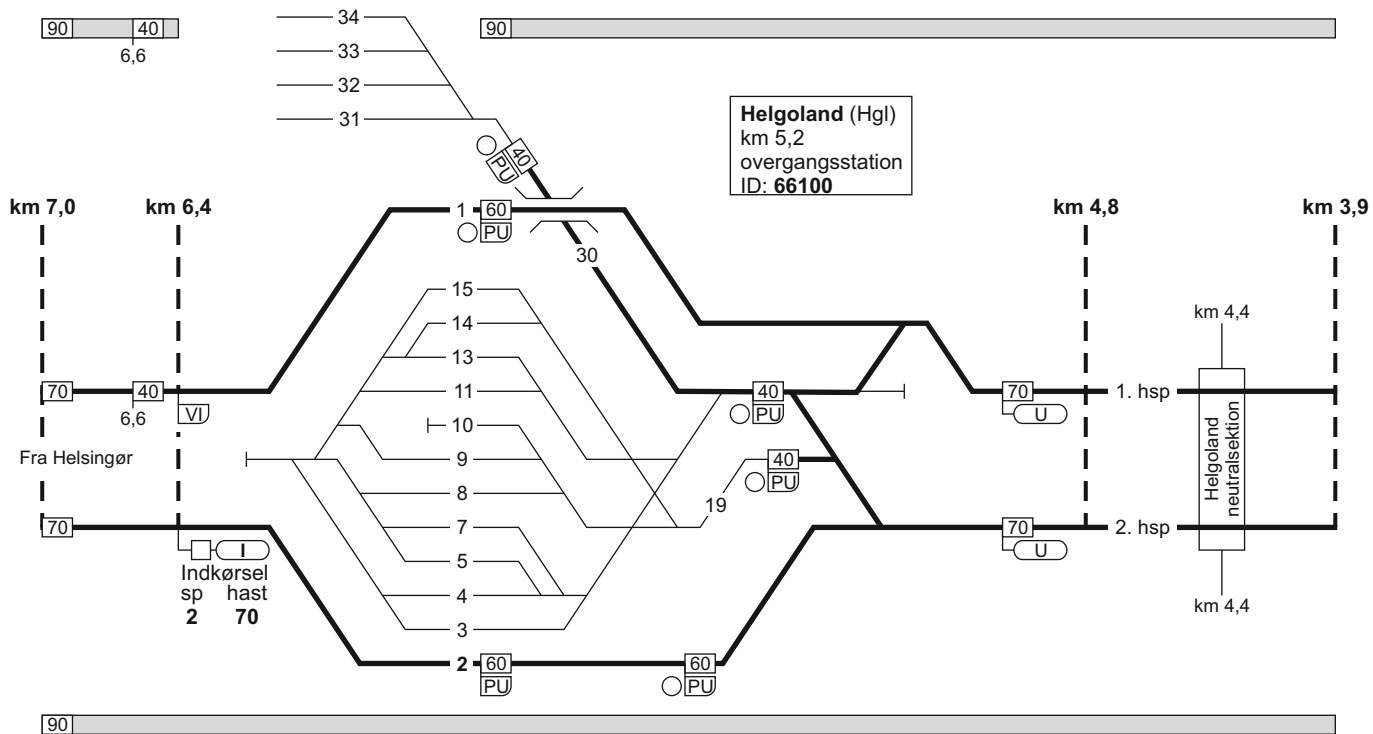

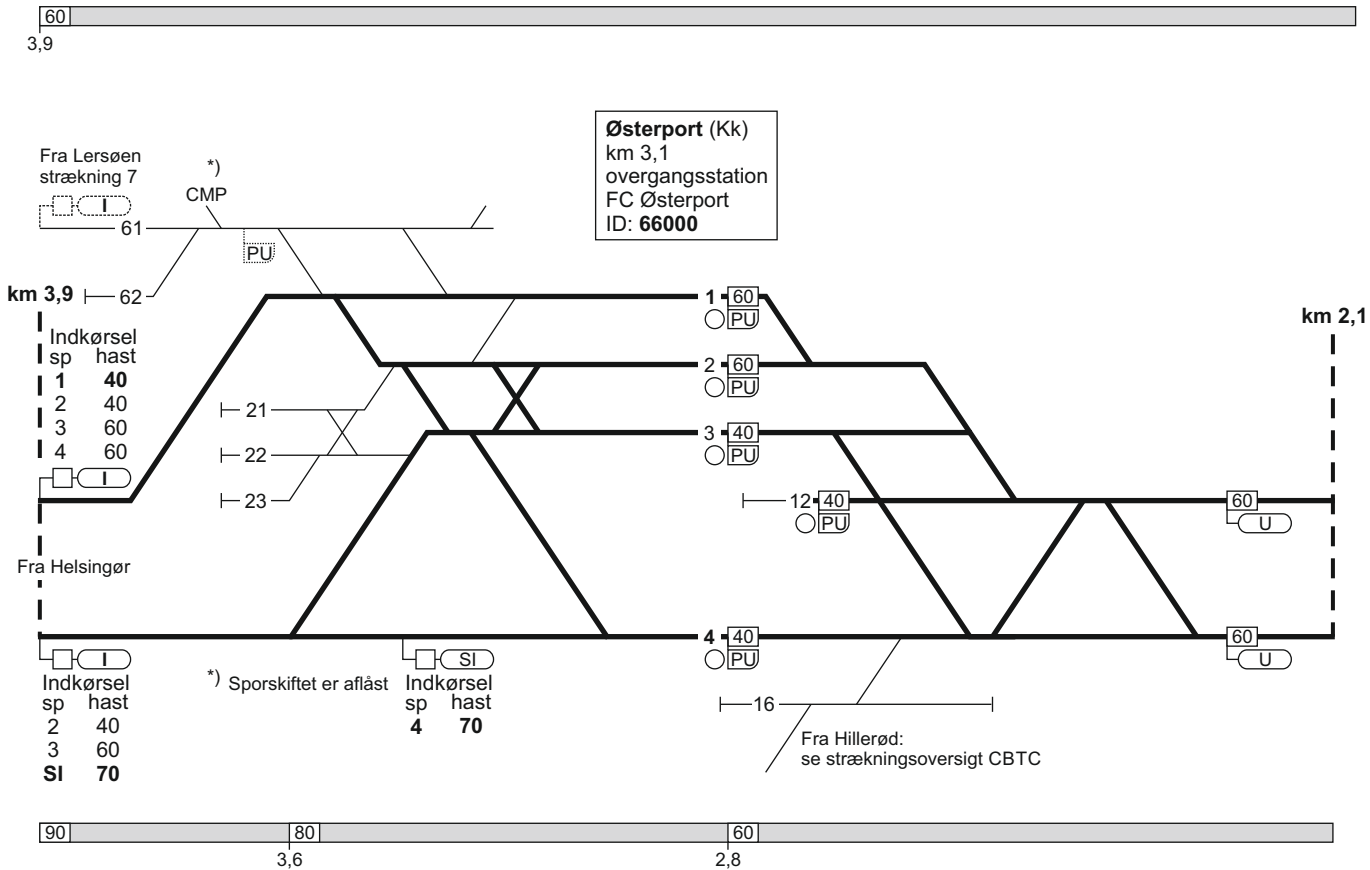

FC Østerport
linjeblok / vekselspor
stigning L

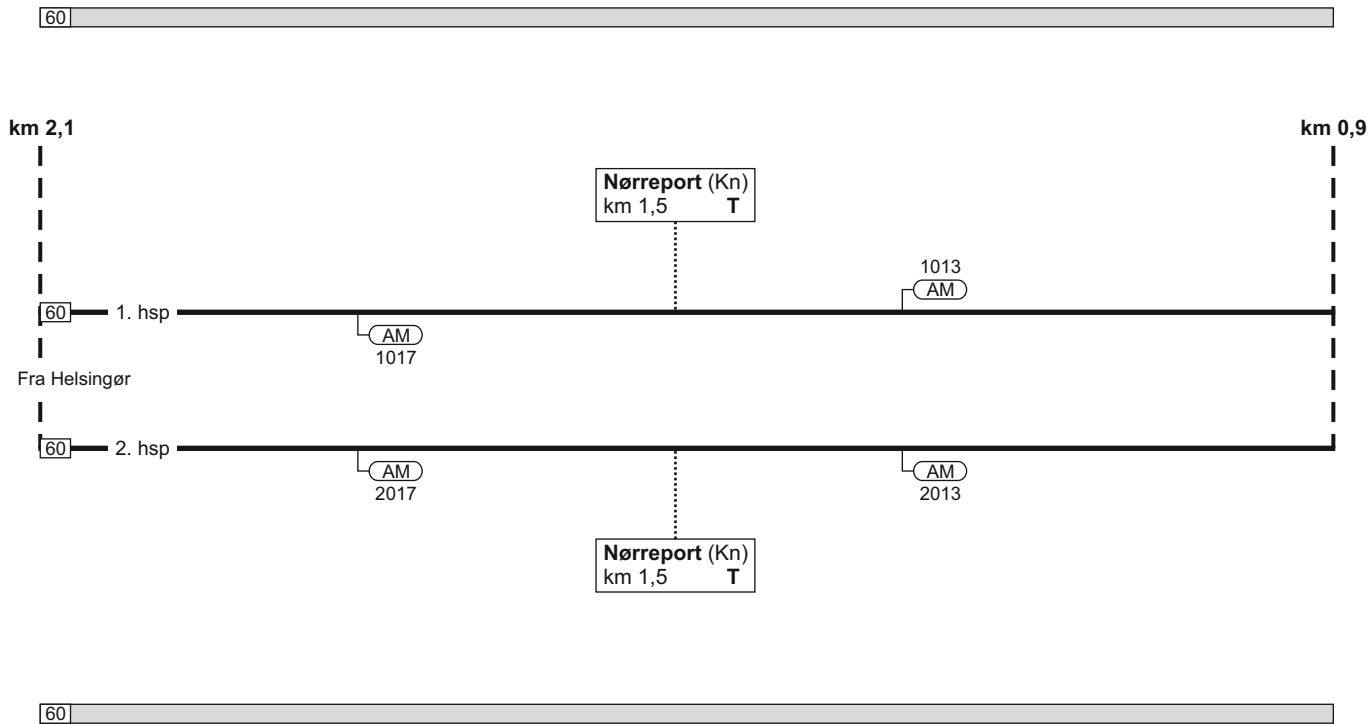

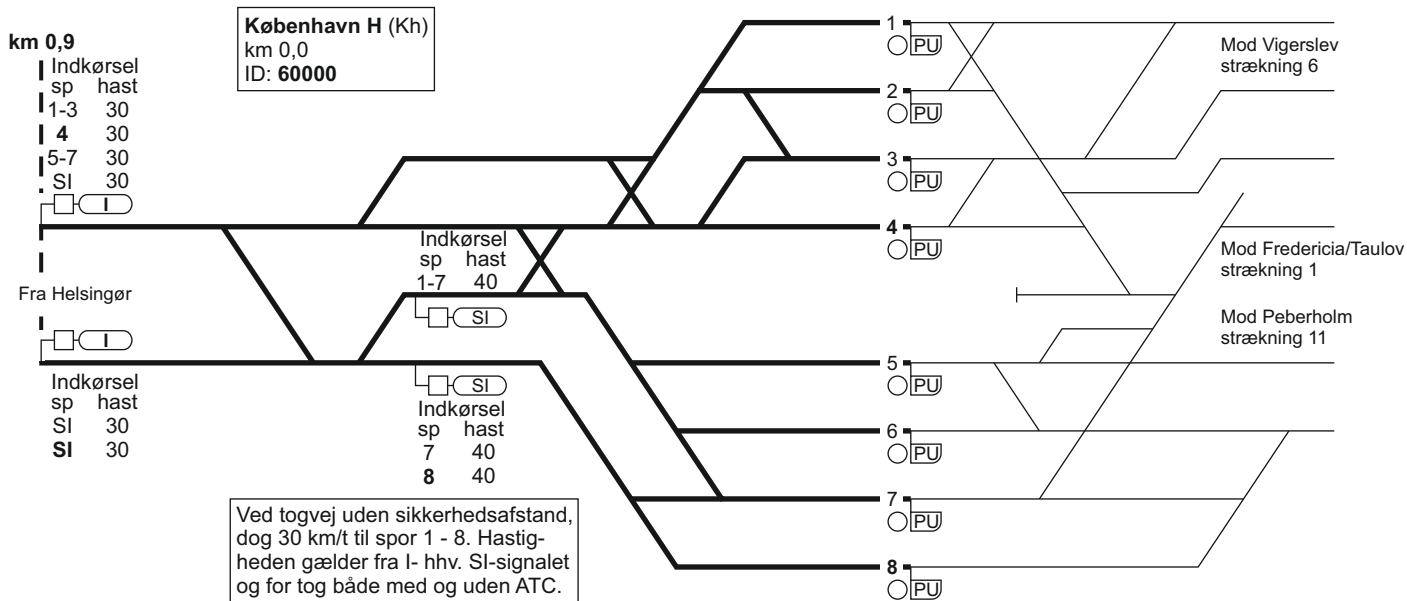
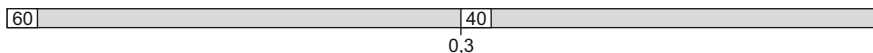

Togekspeditionssted 1	Togfølgestation 2	Sporbenyttelse 3	Standsningssted 4	Kmp/FC telefonnummer 5
København H.			<p>Passagertog der ankommer på hverdage i tidsrummet kl 02.00 - 04.30 og på søndage i tidsrummet kl. 02.00 - 05.30, skal, hvis toglængden er over 200 meter, standse ud for «S-mærket» (SR-mærke 17.18.).</p> <p>Øvrige passagertog, der ankommer i samme tidsrum skal standse ud for deres respektive standsningsmærker (SR-mærke 17.20.).</p>	<p>Kmp: 82 34 12 14 eller 82 34 26 12</p> <p>GSM-R: 81 99 12 00</p> <p>FC Østerport: Kh (ekskl.) - Hgl (ekskl.) 82 34 42 74</p> <p>GSM-R: 81 99 12 60</p> <p>FC Kyst: Hgl (ekskl.) - Hg (ekskl.) 82 34 42 75</p> <p>GSM-R: 81 99 12 02</p>
Østerport			<p>Ankommende tog i spor 12 bestående af 11 køretøjer skal køre helt frem til mærke «Stop».</p> <p>For stammer som udtages på Østerport, hhv. fortsætter som materieltog til Helgoland, afgiver tgf. færdigmelding til lkf.</p>	<p>Kmp: 82 34 42 74</p> <p>GSM-R: 81 99 12 60</p>

Togekspeditionssted 1	Togfølgestation 2	Sporbenyttelse 3	Standsningssted 4	Kmp/FC telefonnummer 5
Helgoland				Kmp: 82 34 24 43 GSM-R: 81 99 12 61
Helsingør				Kmp: 82 34 09 11 GSM-R: 81 99 12 62

11. København H / Hvidovre Fjern - Peberholm**Strækningshastighed:**

Delstrækning	Strækningshastighed (km/t)
København H / Vigerslev - Københavns Lufthavn Kastrup	160
Hvidovre Fjern - Vigerslev	100
Københavns Lufthavn Kastrup - Peberholm	180

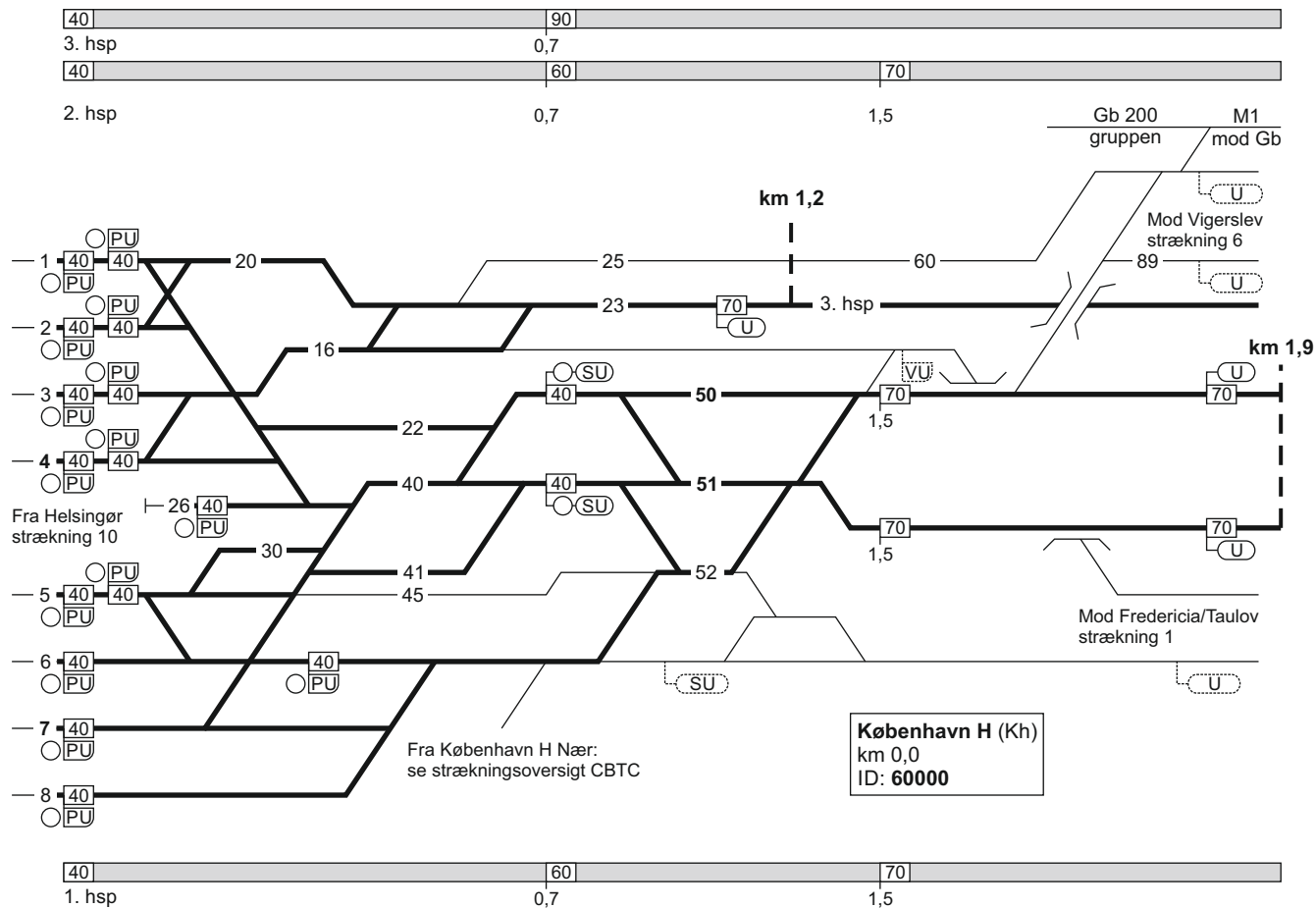

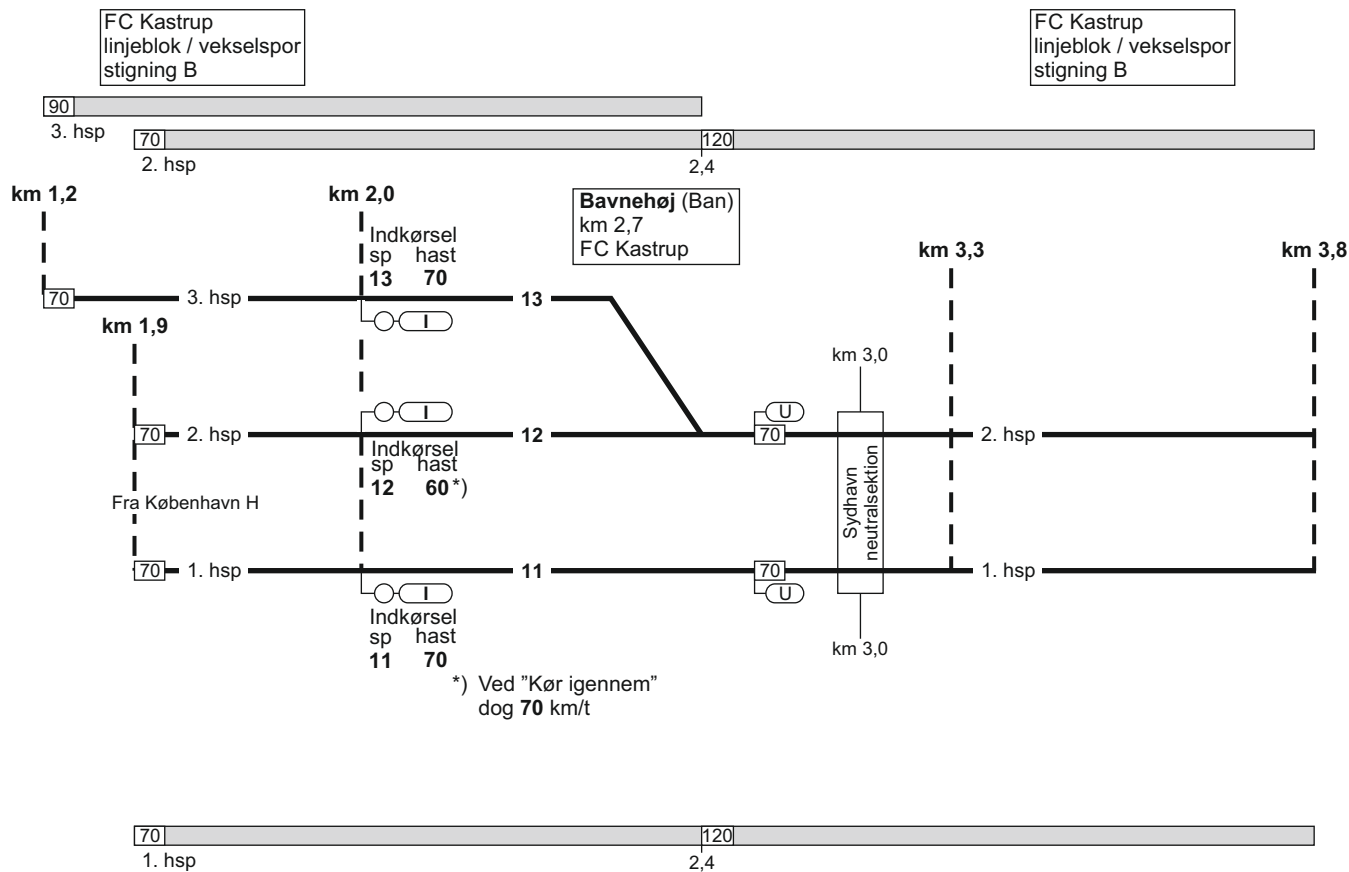

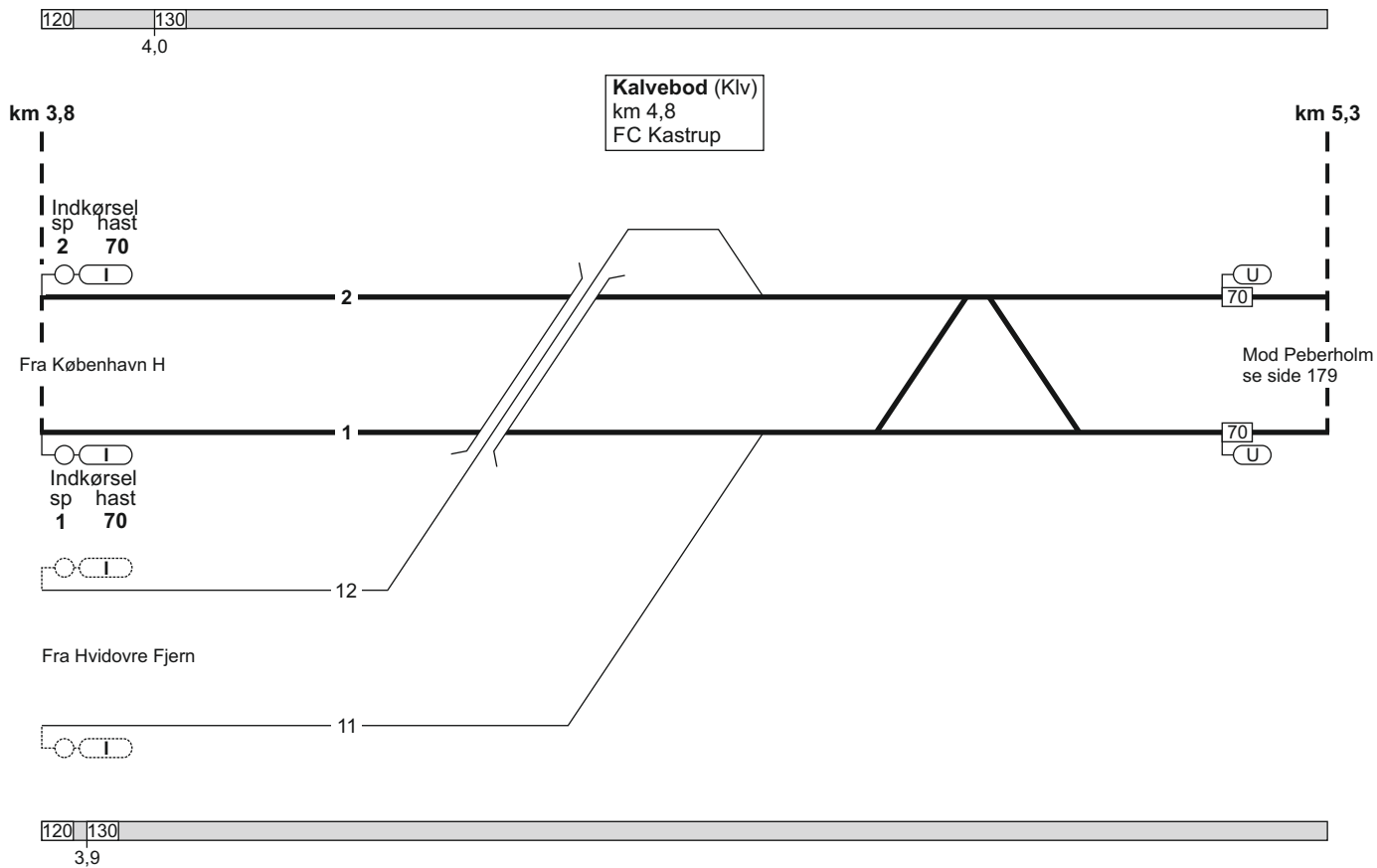

FC Glostrup
linjeblok
stigning M

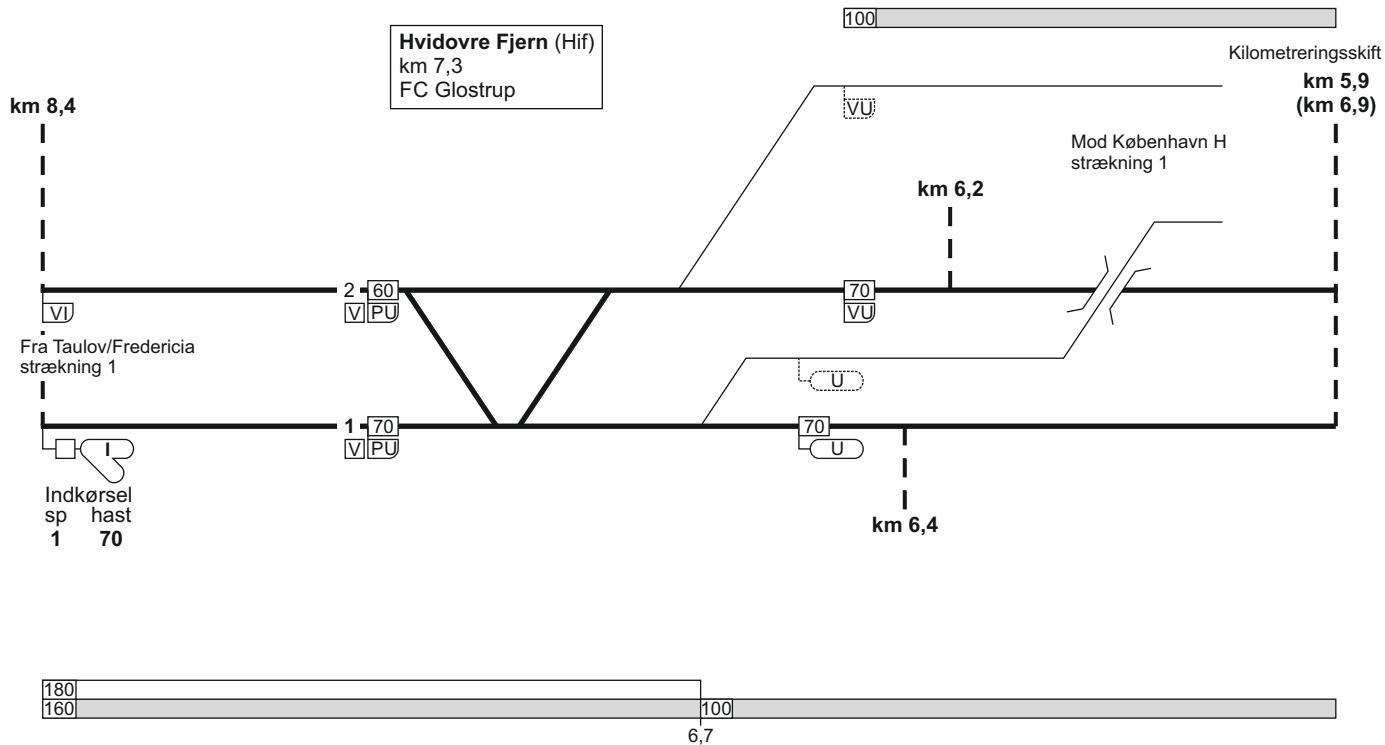

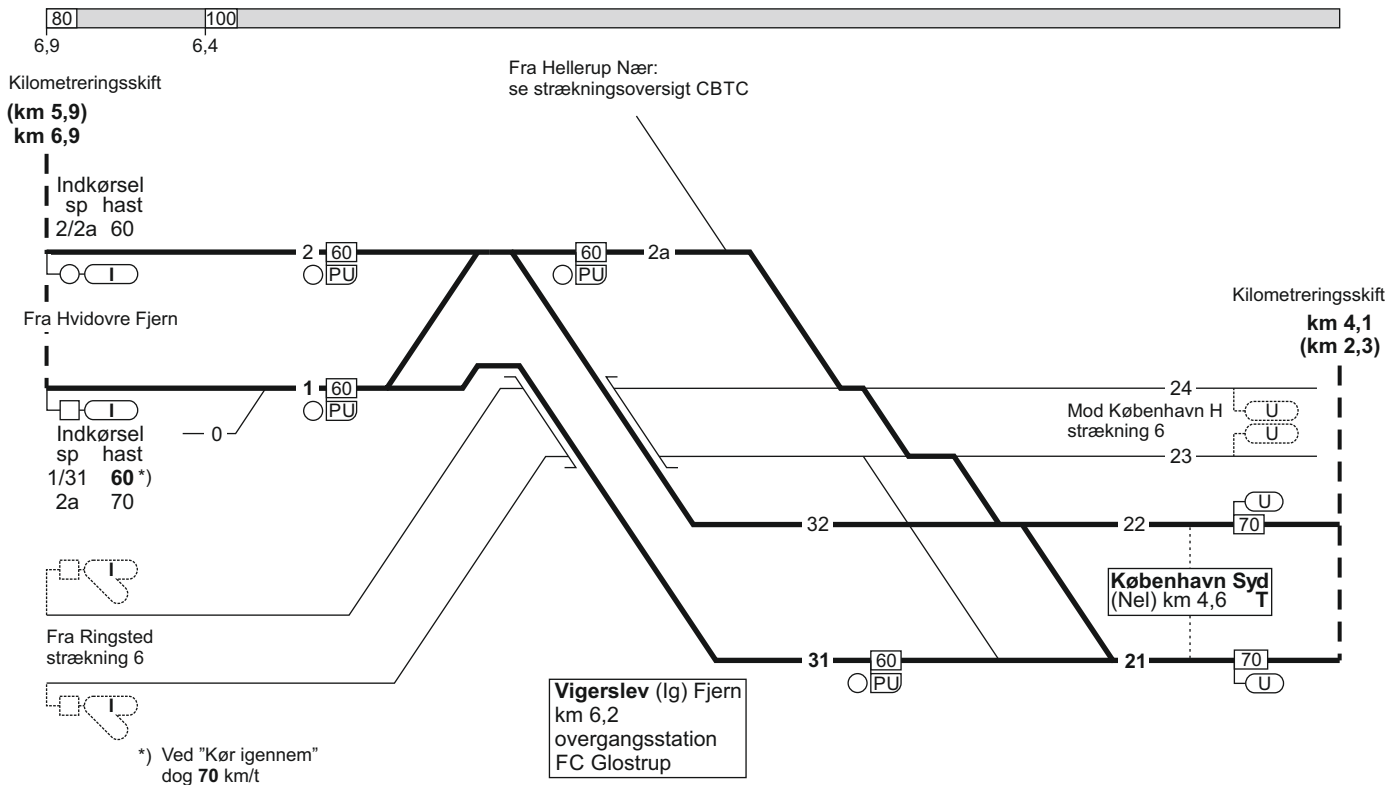

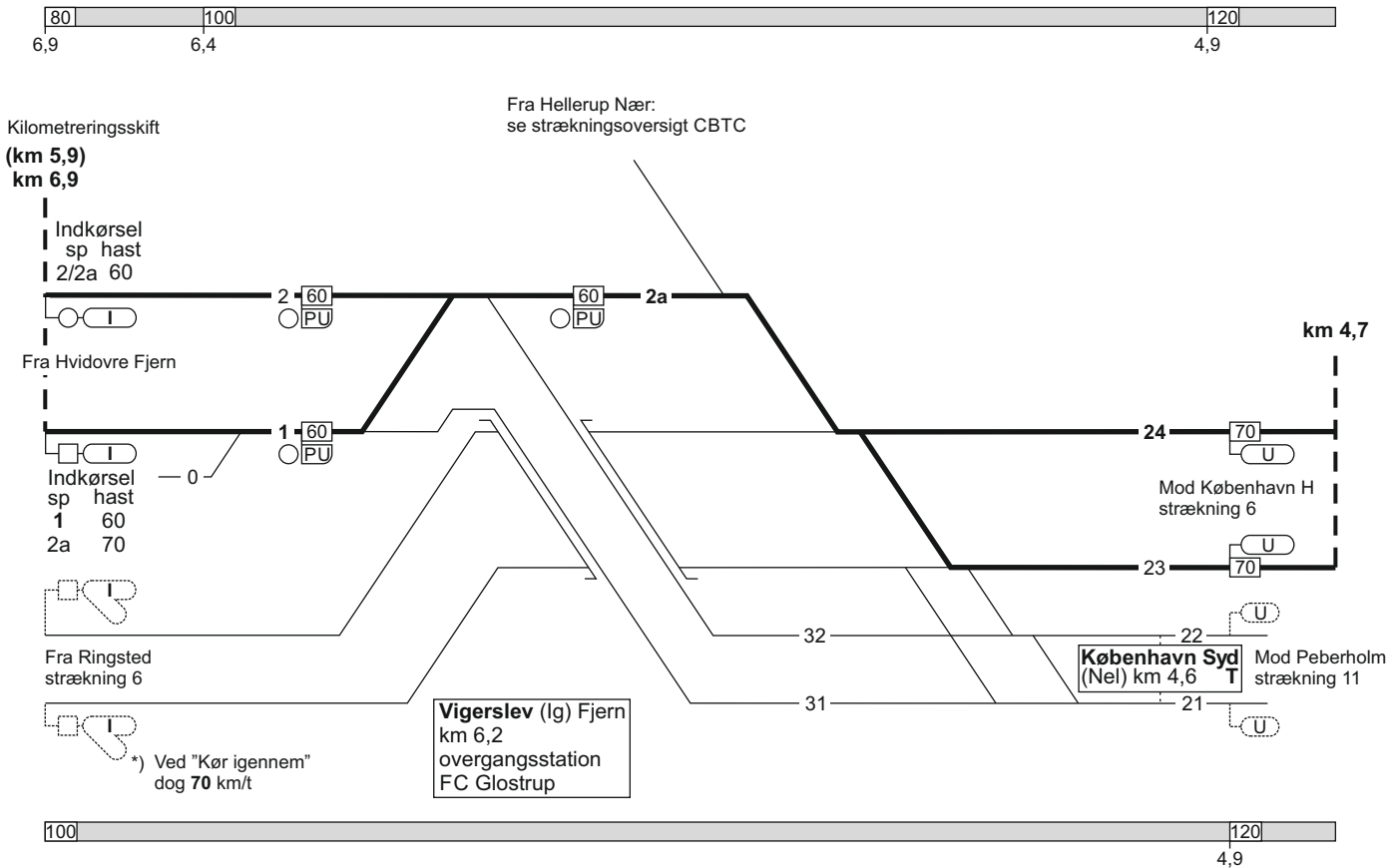

FC Glostrup
linjeblok / vekselspor
stigning F

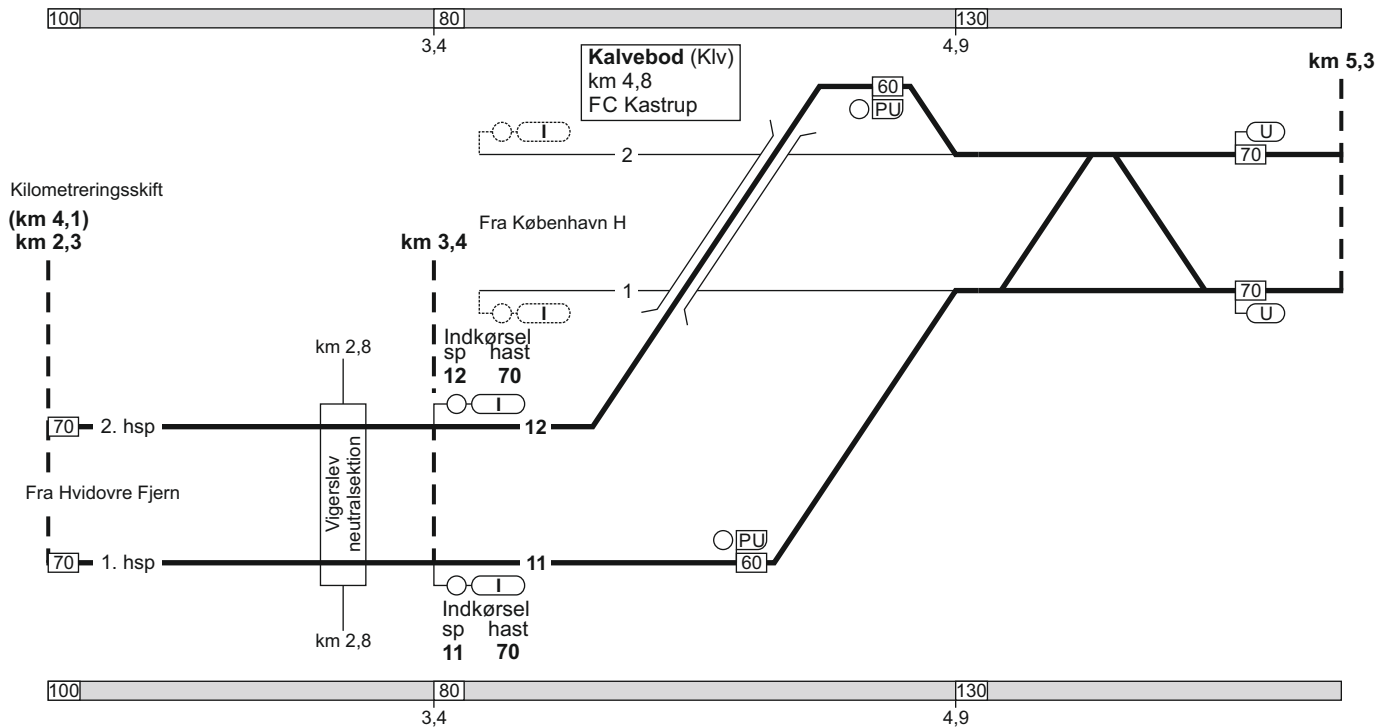

FC Kastrup
linjeblok / vekselspor
stigning F

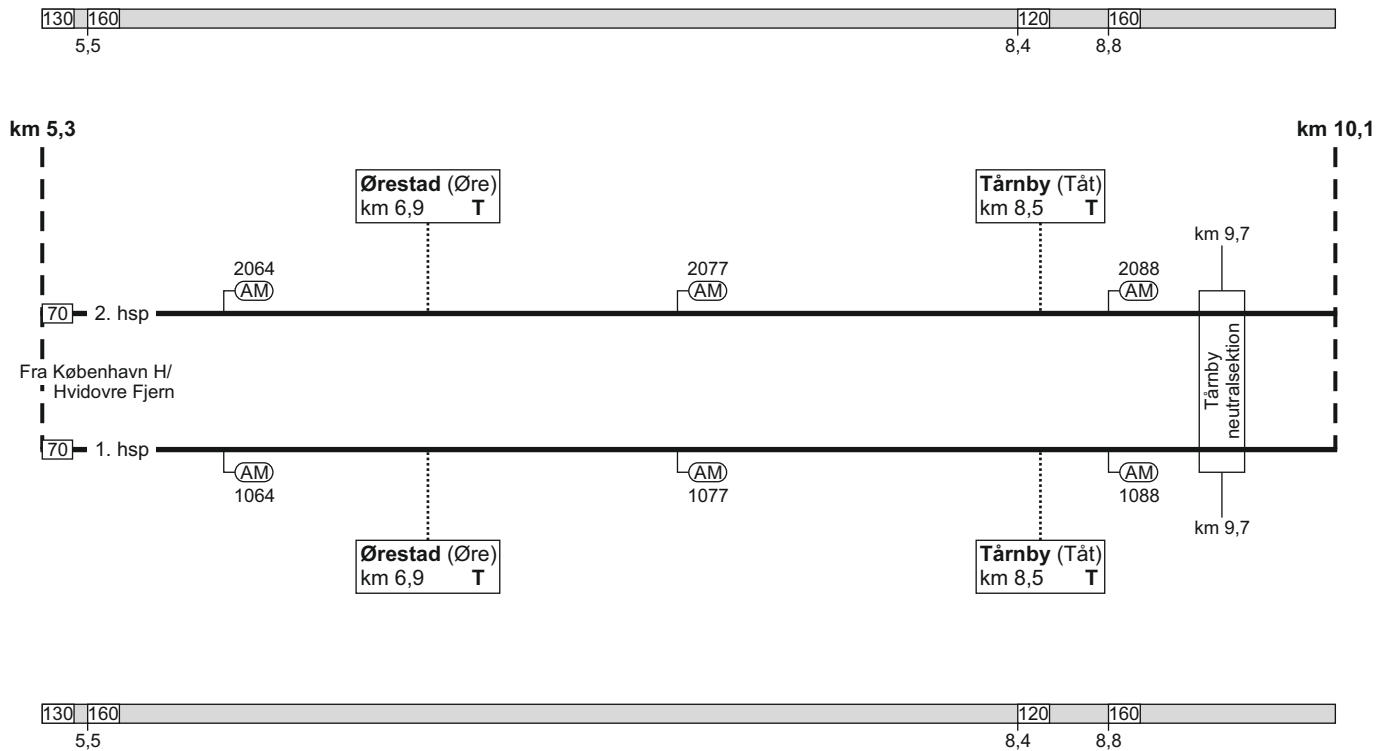

Spor 12



km 10,1

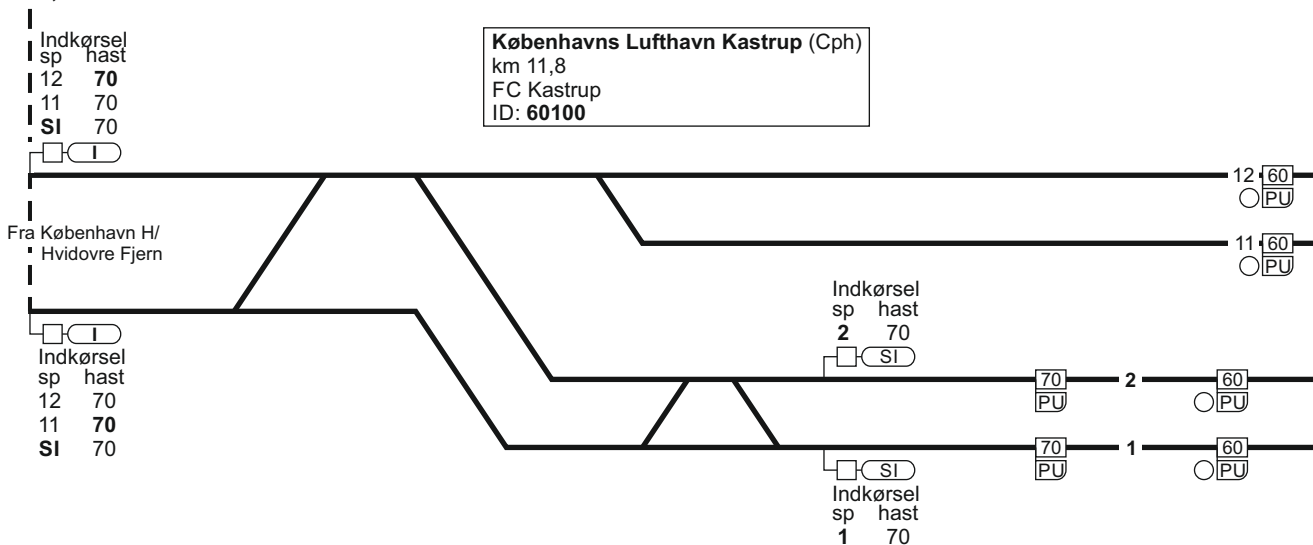

Spor 11



FC Kastrup / A79
linjeblok / vekselspor
stigning D

Spor 12



Københavns Lufthavn Kastrup (Cph)
km 11,8
FC Kastrup
ID: 60100

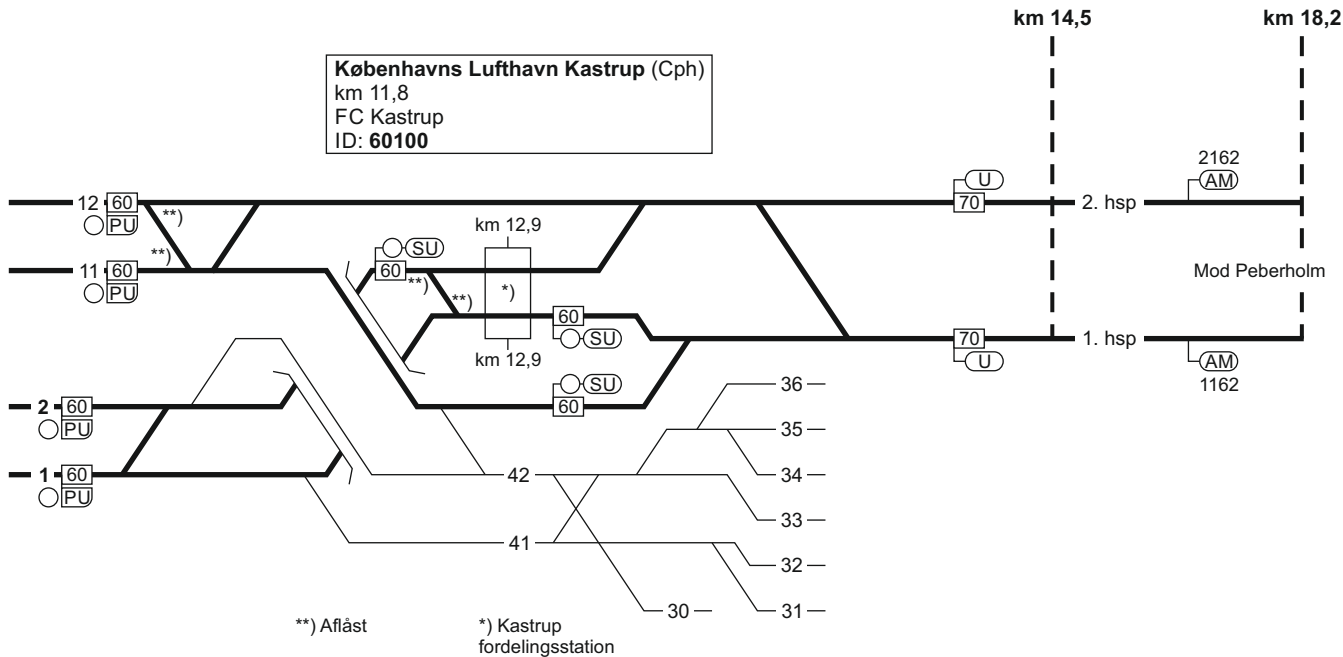

Spor 11

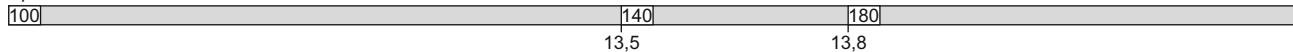

Spor 11



Københavns Lufthavn Kastrup (Cph)
 km 11,8
 FC Kastrup
 ID: 60100

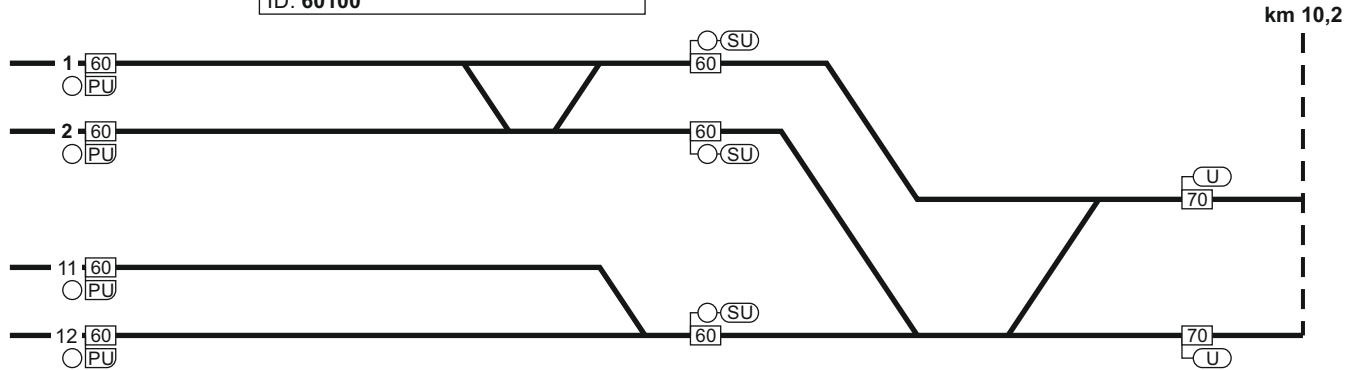

Spor 12

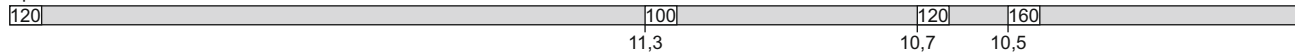

FC Kastrup
linjeblok / vekselspor
stigning H

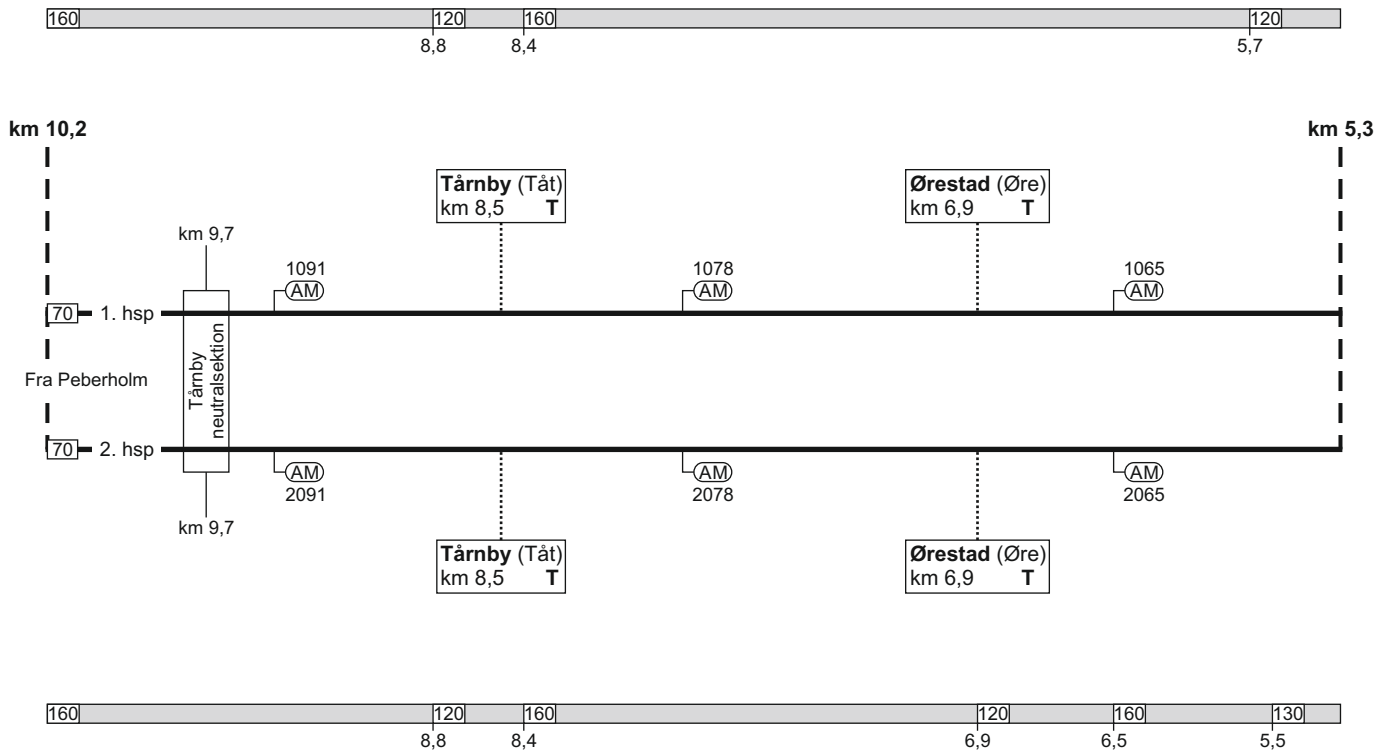

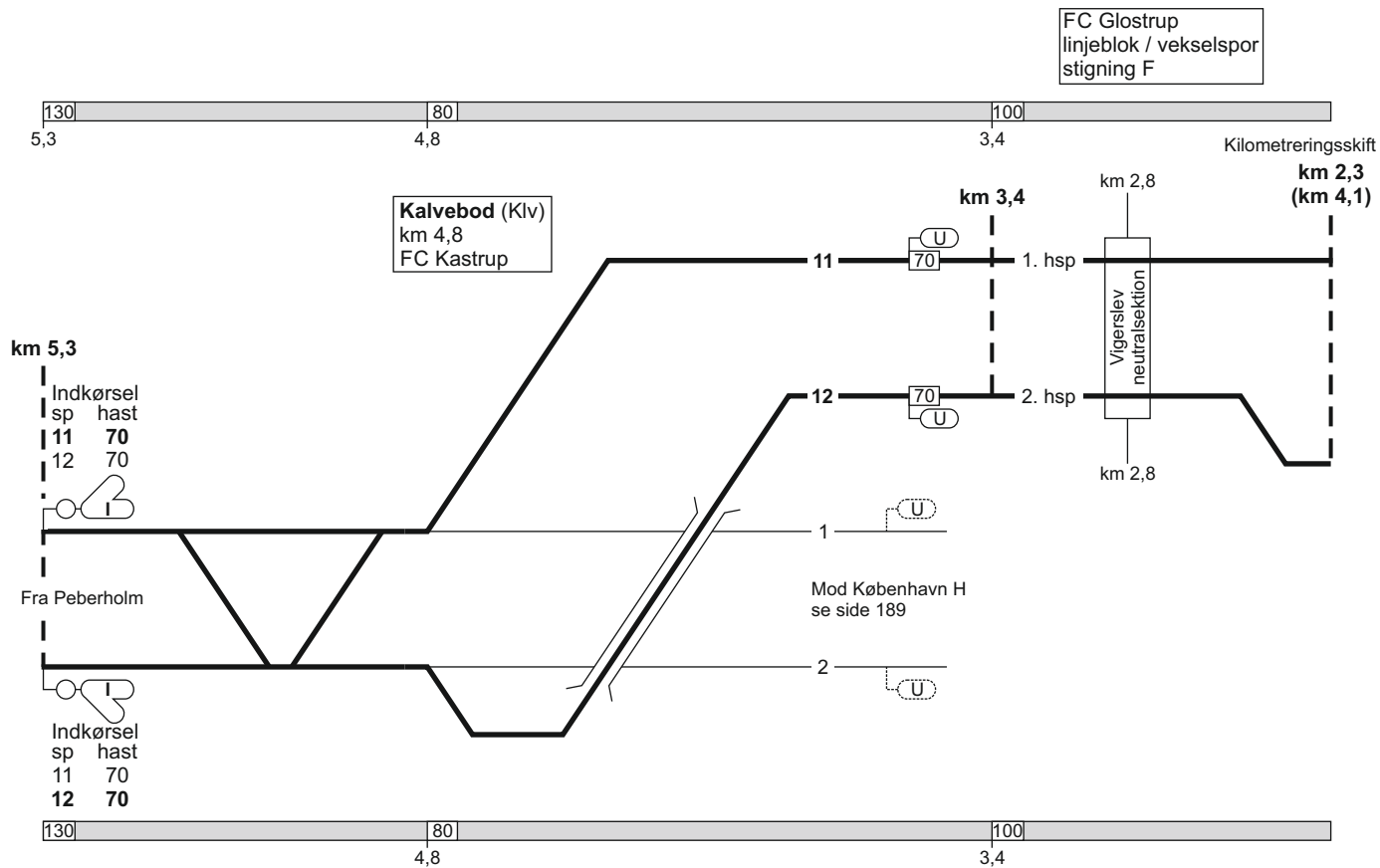

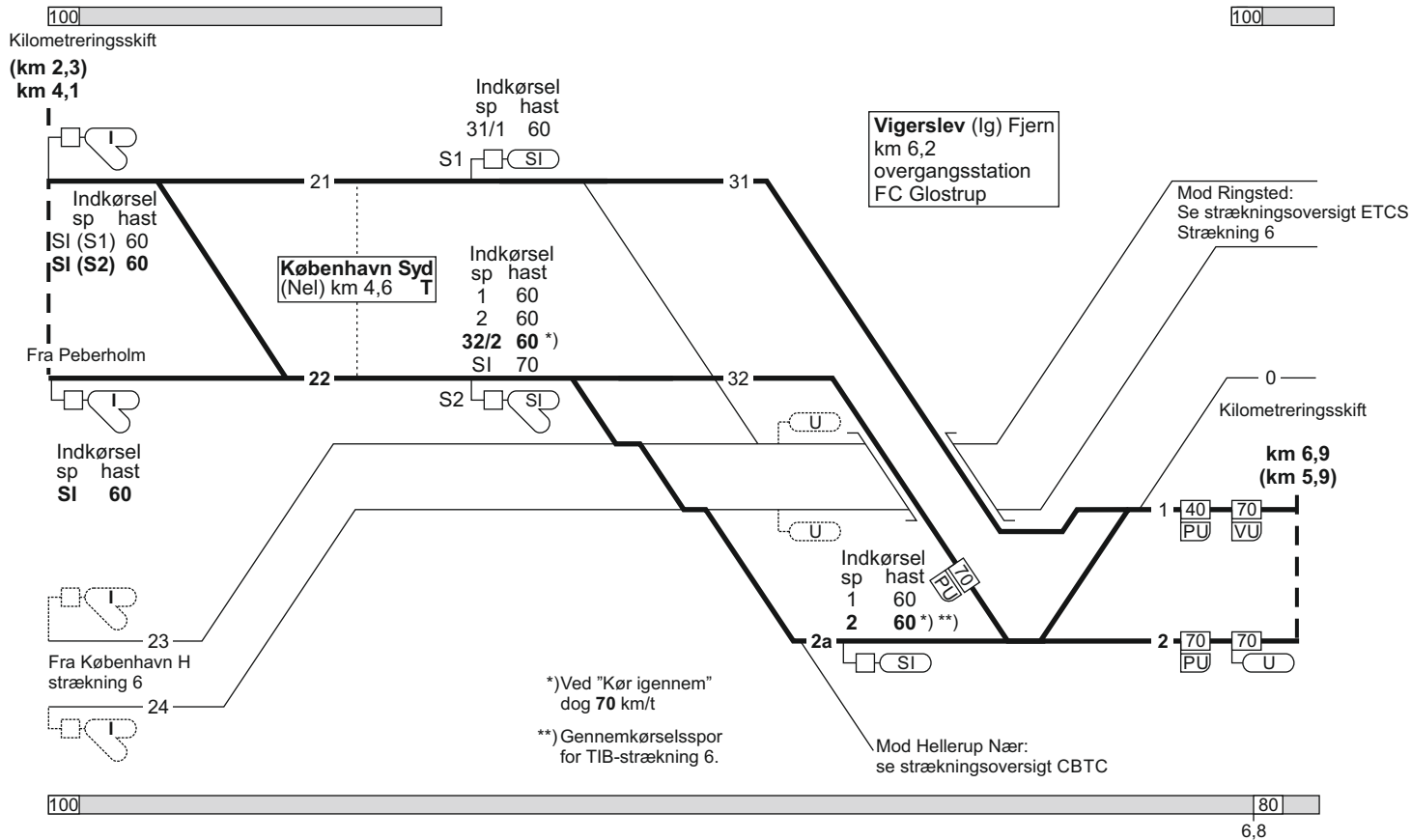

FC Glostrup
linjeblok
stigning L

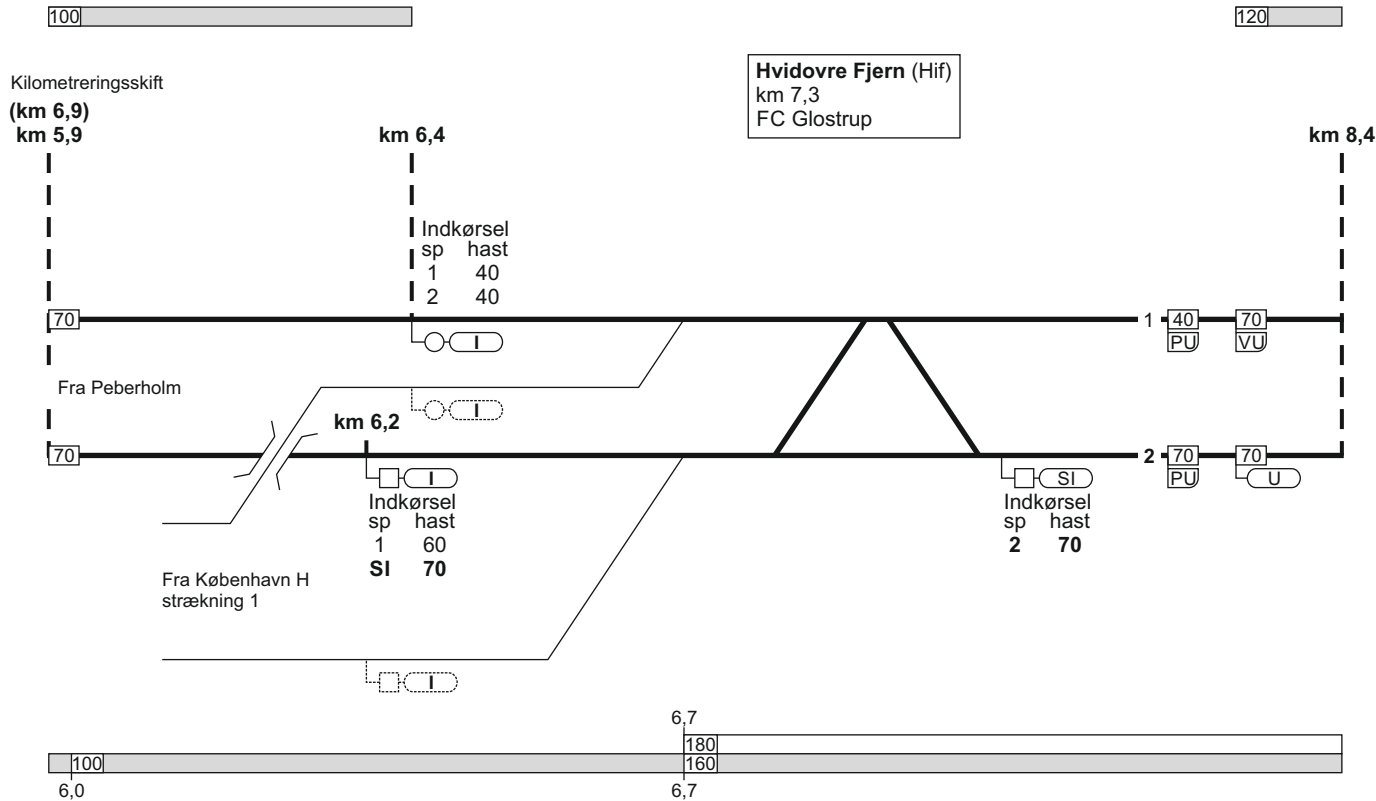

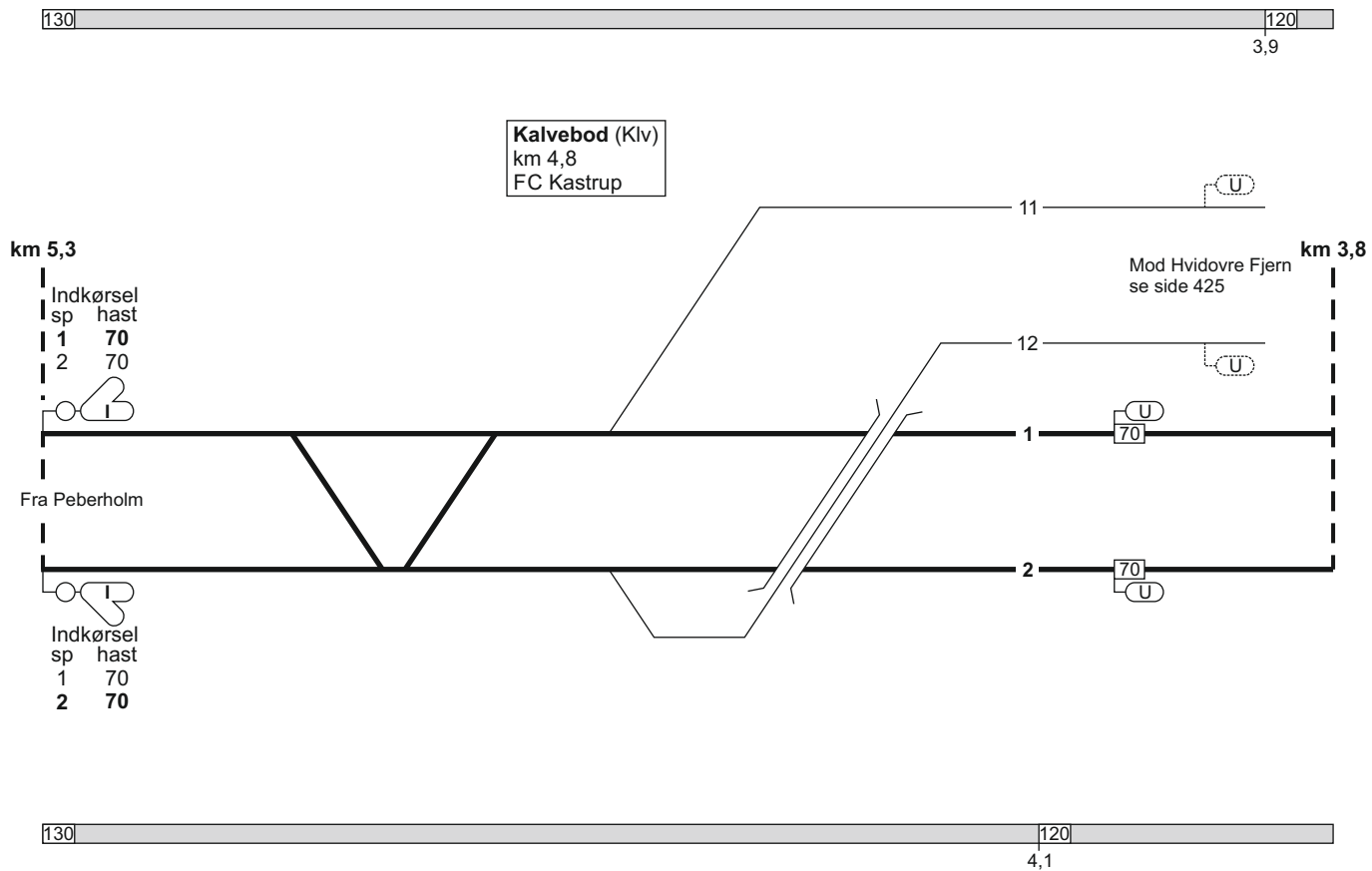

FC Kastrup
linjeblok / vekselspor
stigning B

FC Kastrup
linjeblok / vekselspor
stigning B

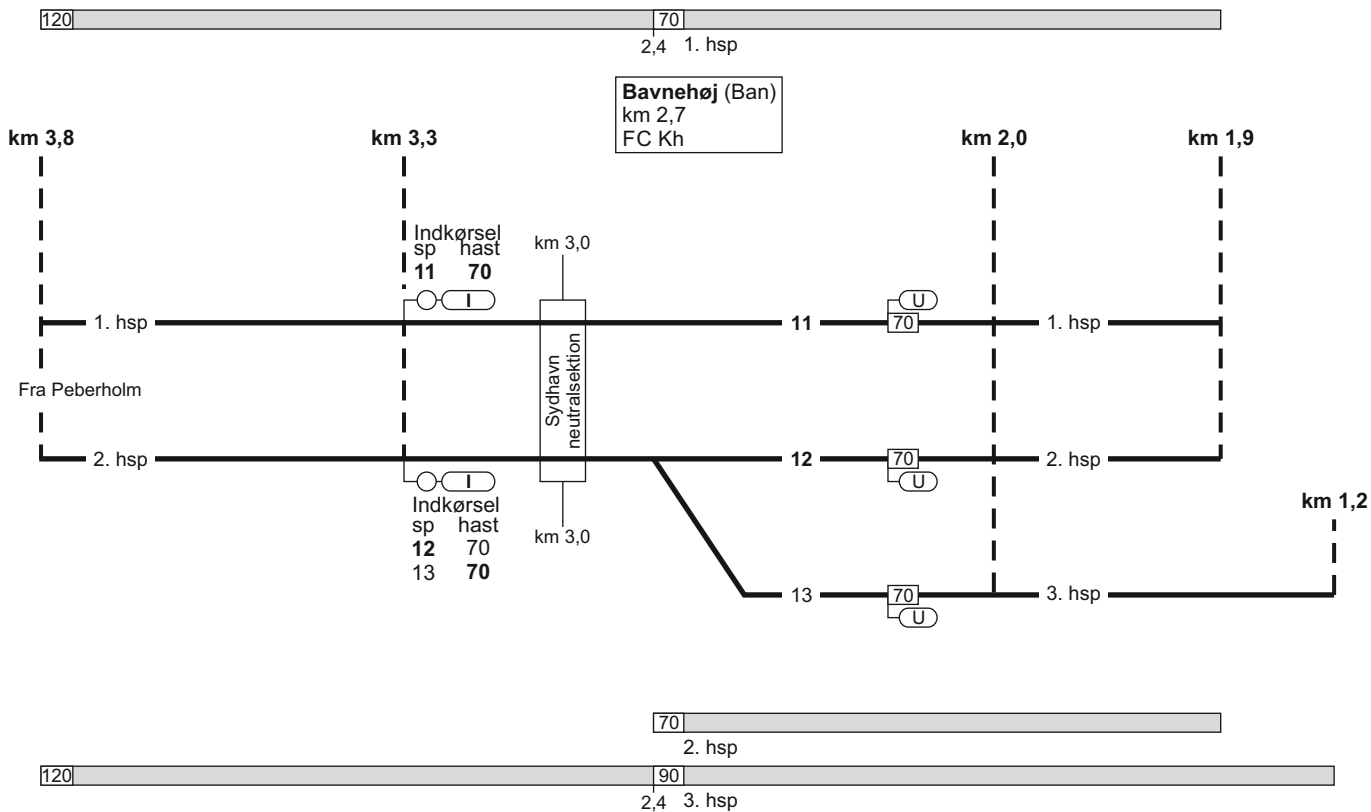

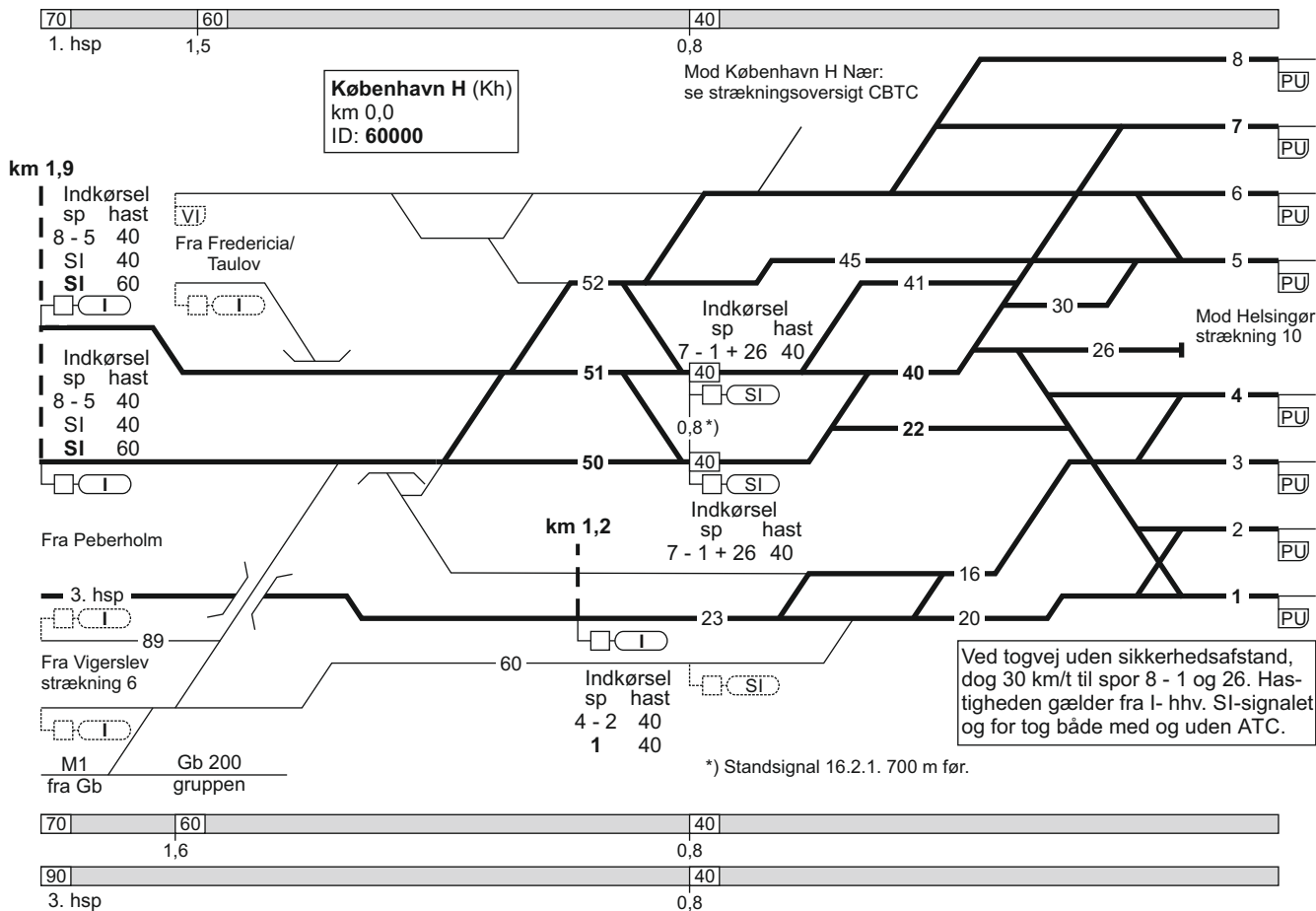

Togekspeditionssted 1	Togfølgestation 2	Sporbenyttelse 3	Standsningssted 4	Kmp/FC telefonnummer 5
København H.			<p>Spør 1-8: Tog fremført af diesellokomotiver standser med forreste køretøj i røgåbningen. Ved forspandskørsel dog med bageste lokomotiv i røgåbningen.</p> <p>Passagertog der ankommer på hverdage i tidsrummet kl 02.00 - 04.30 og på søn - og helligedage i tidsrummet kl. 02.00 - 05.30, skal, uanset toglængde standse ud for «200-metermærket» (SR-mærke 17.20.).</p>	<p>Kmp: 82 34 12 14 eller 82 34 26 12</p> <p>GSM-R: 81 99 12 00</p> <p>FC Glostrup: Hif (ekskl.) - Klv (ekskl.) 82 34 18 80</p> <p>GSM-R: 81 99 12 01</p>

Togekspeditionssted 1	Togfølgestation 2	Sporbenyttelse 3	Standsningssted 4	Kmp/FC telefonnummer 5
Københavns Lufthavn Kastrup			Spør 1 og 2: Tog fra Kalvebod som efter ankomst skal bortrangeres, skal køre helt frem til «SR-mærke» (SR-mærke 17.18). Ved signalgivning «Kør» til «Togvej uden sikkerhedsafstand» fra SI-signal skal tog køre helt frem til togvejens endepunkt.	FC Kastrup: Kh (ekskl.) - Klv - Phm (ekskl.) 82 34 61 43 GSM-R: 81 99 12 08

21. Odense - Svendborg**Strækningshastighed:**

Delstrækning	Strækningshastighed (km/t)
Odense - Svendborg	120

Odense (Od)
 km 160,3
 overgangsstation
 ID: 66800

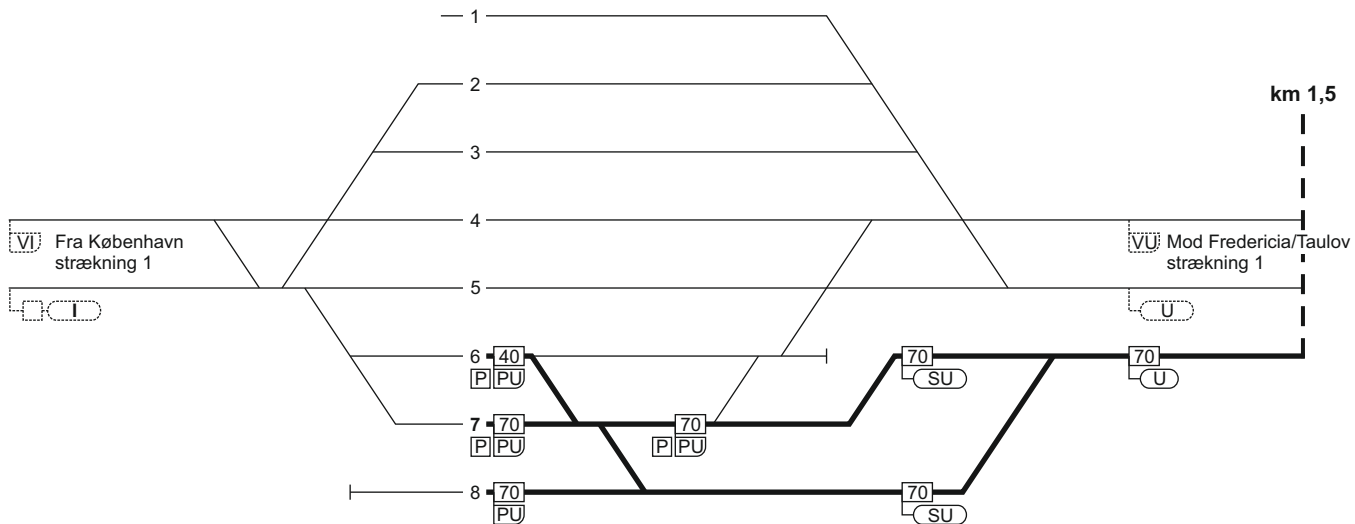

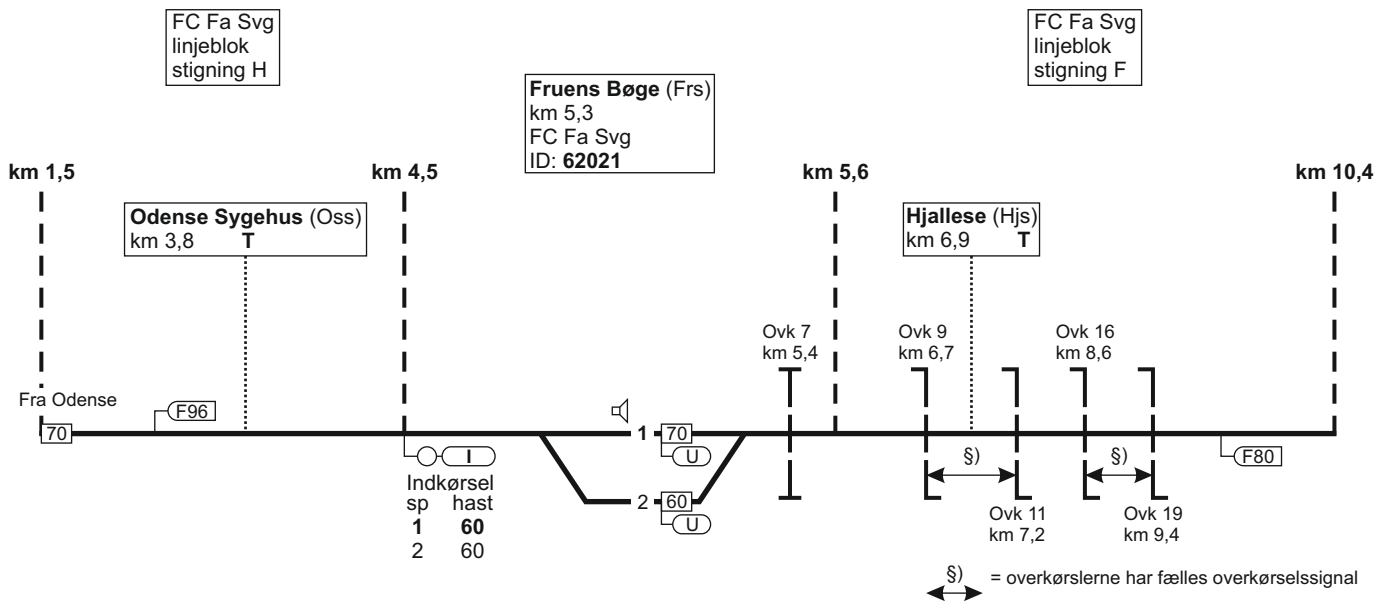

Højby (Høs)
 km 11,0
 FC Fa Svg

FC Fa Svg
 linjeblok
 stigning F

Årslev (Ås)
 km 14,9
 FC Fa Svg

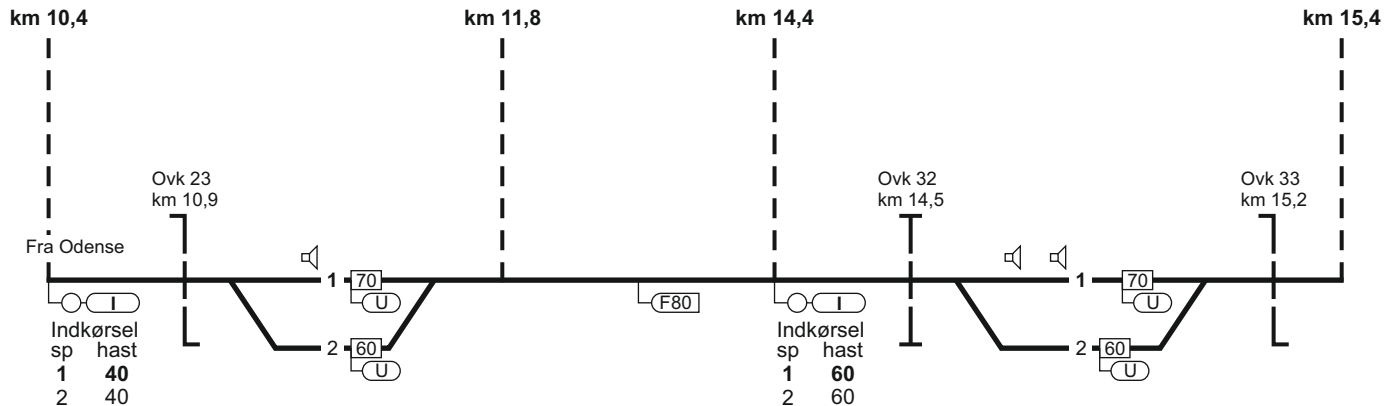

FC Fa Svg
linjeblok
stigning F

Ringe (Re)
km 22,4
FC Fa Svg

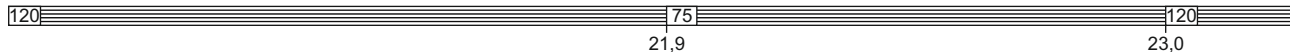
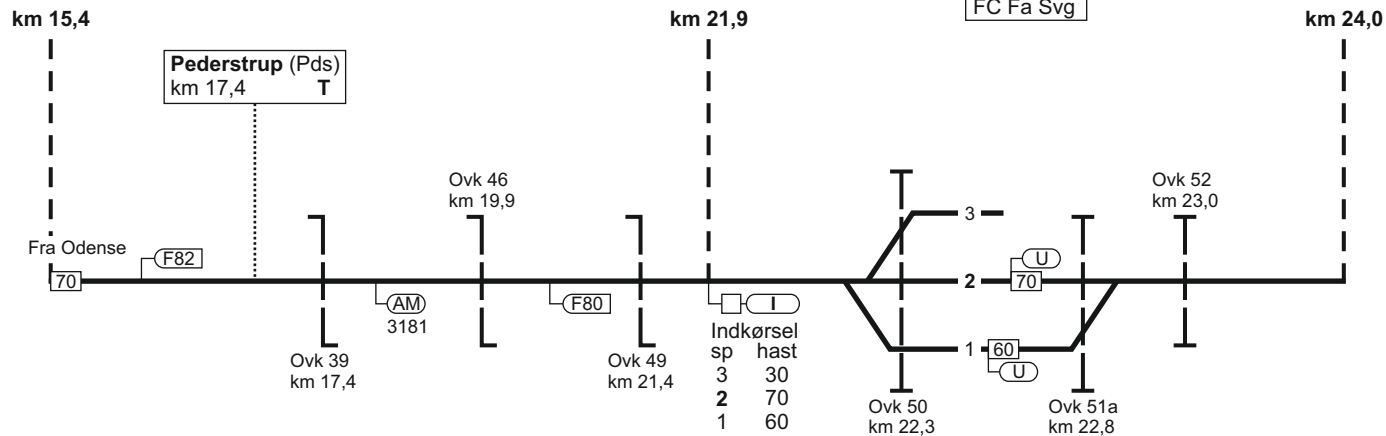

FC Fa Svg
linjeblok
stigning F

Kværndrup (Kvs)
km 30,2
FC Fa Svg

FC Fa Svg
linjeblok
stigning G

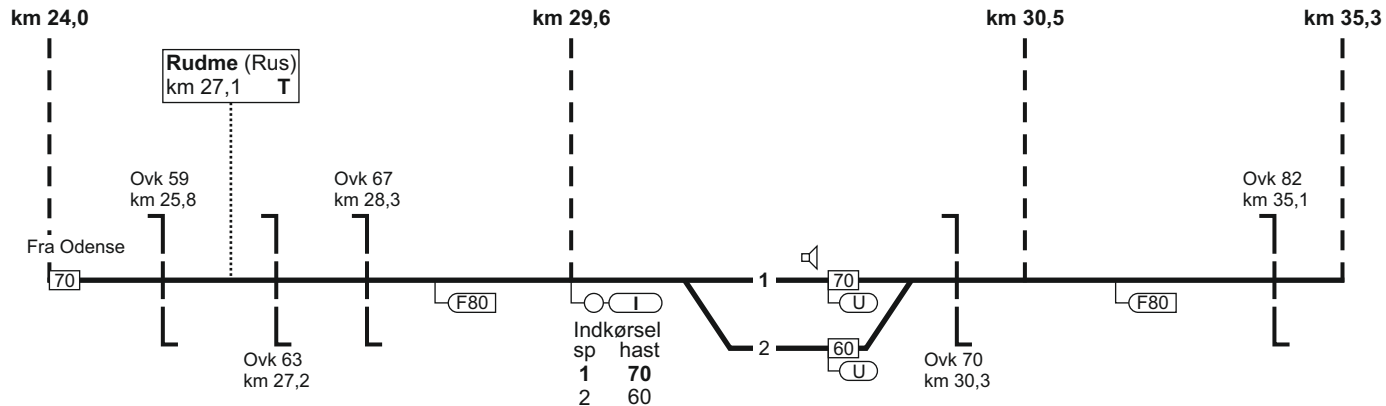

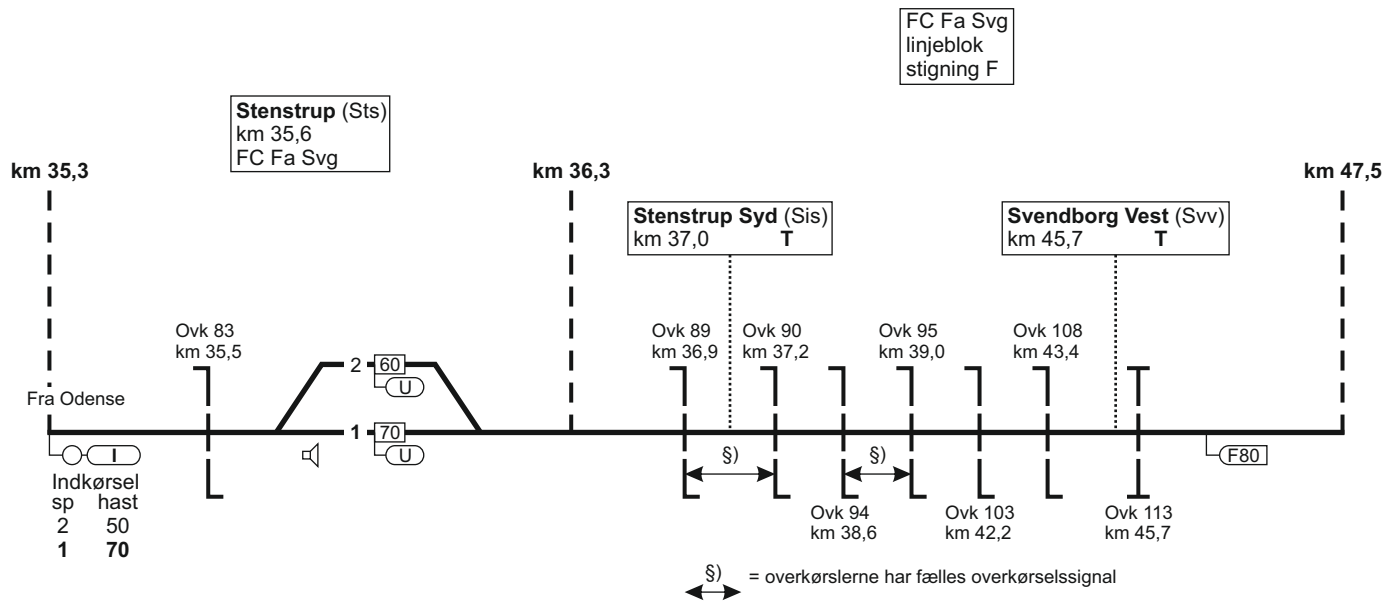

Svendborg (Svg)
 km 48,2
 FC Fa Svg

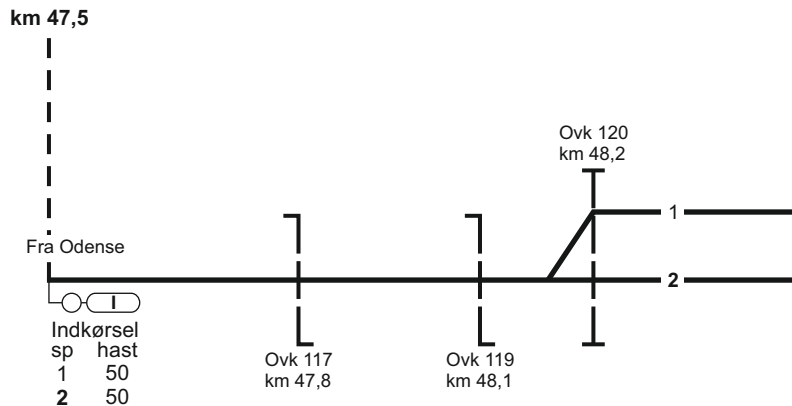

Svendborg (Svg)
km 48,2
FC Fa Svg

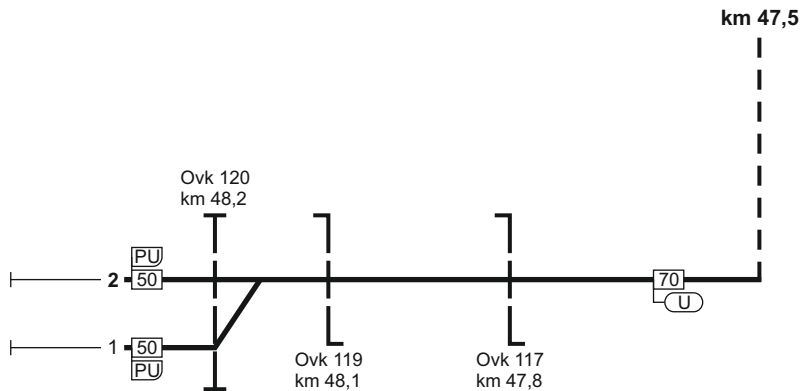

FC Fa Svg
linjeblok
stigning F

Stenstrup (Sts)
km 35,6
FC Fa Svg

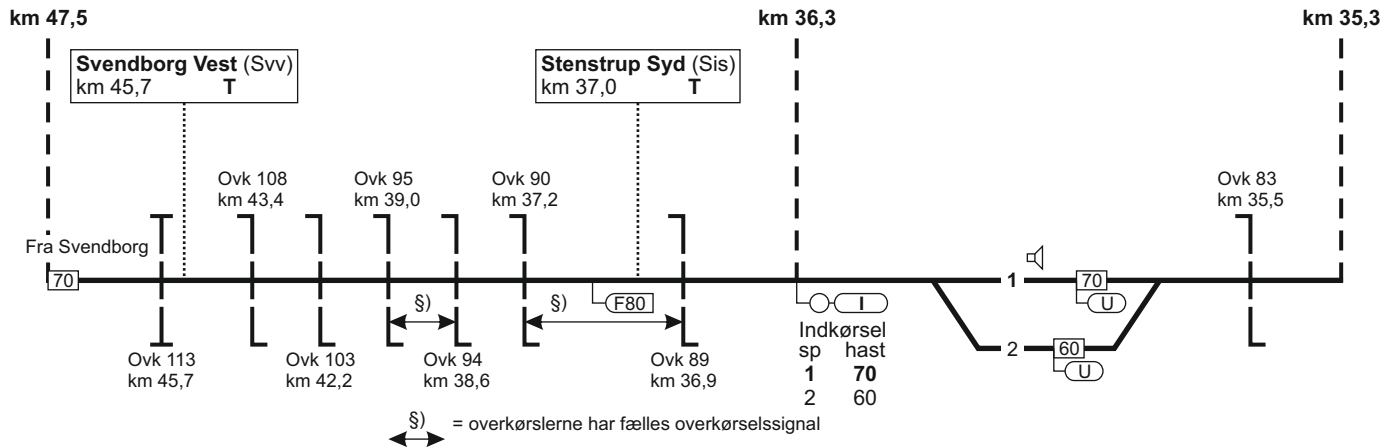

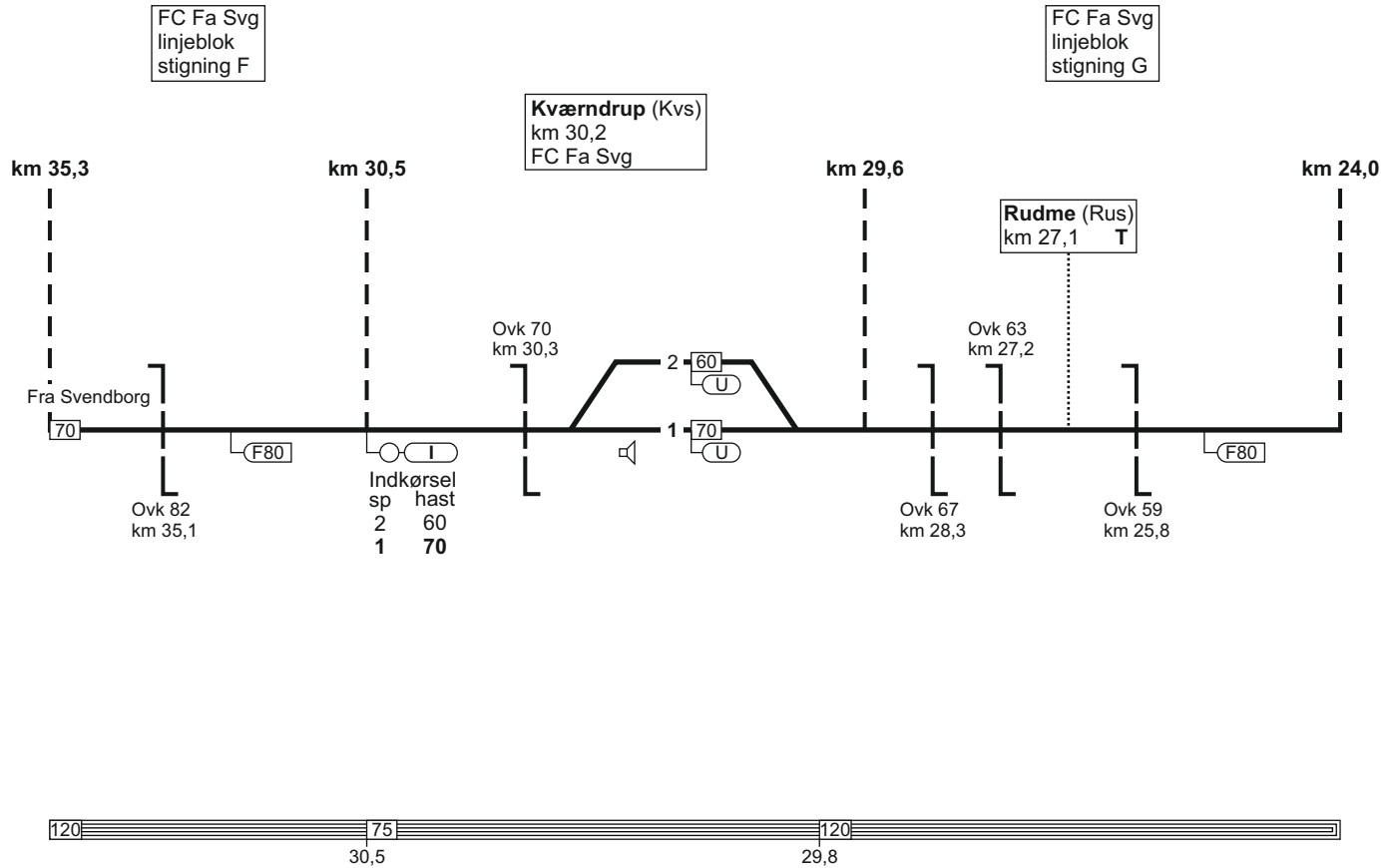

Ringe (Re)
 km 22,4
 FC Fa Svg

FC Fa Svg
 linjeblok
 stigning L

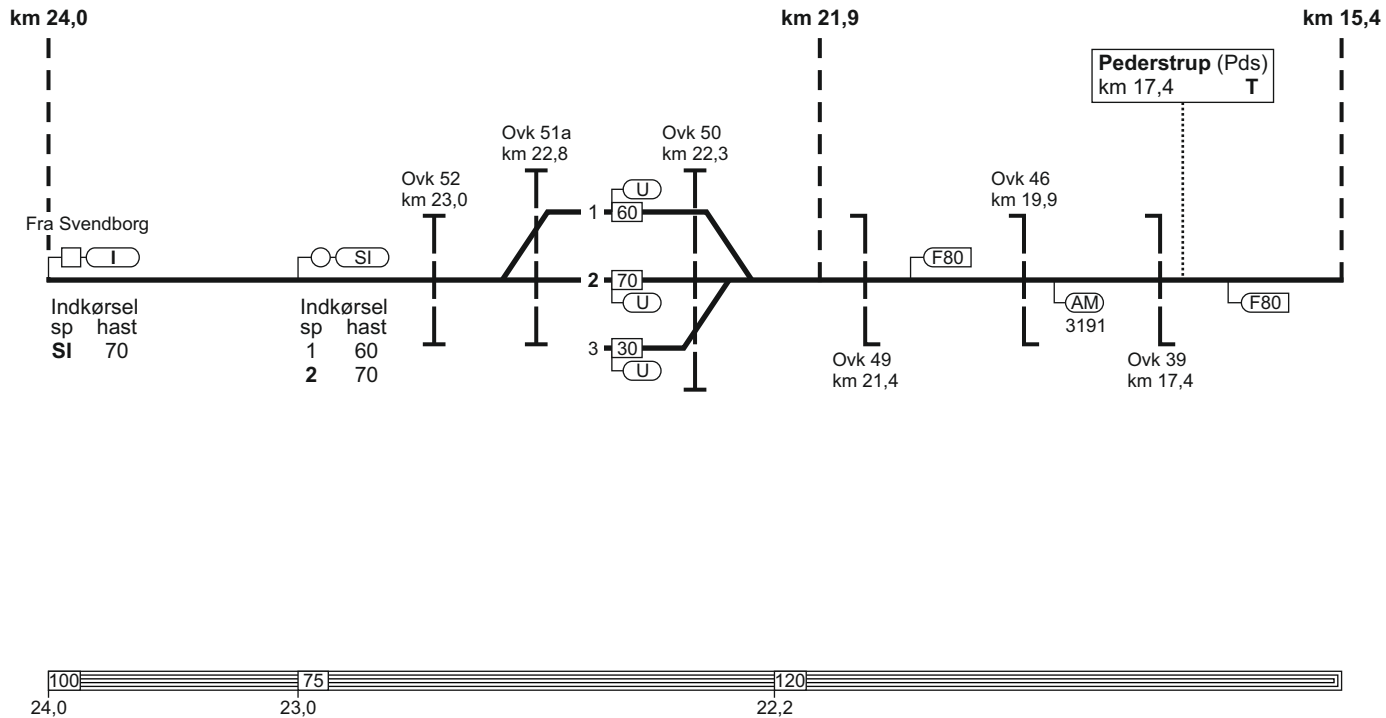

Årslev (Ås)
 km 14,9
 FC Fa Svg

FC Fa Svg
 injeblok
 stigning L

Højby (Høs)
 km 11,0
 FC Fa Svg

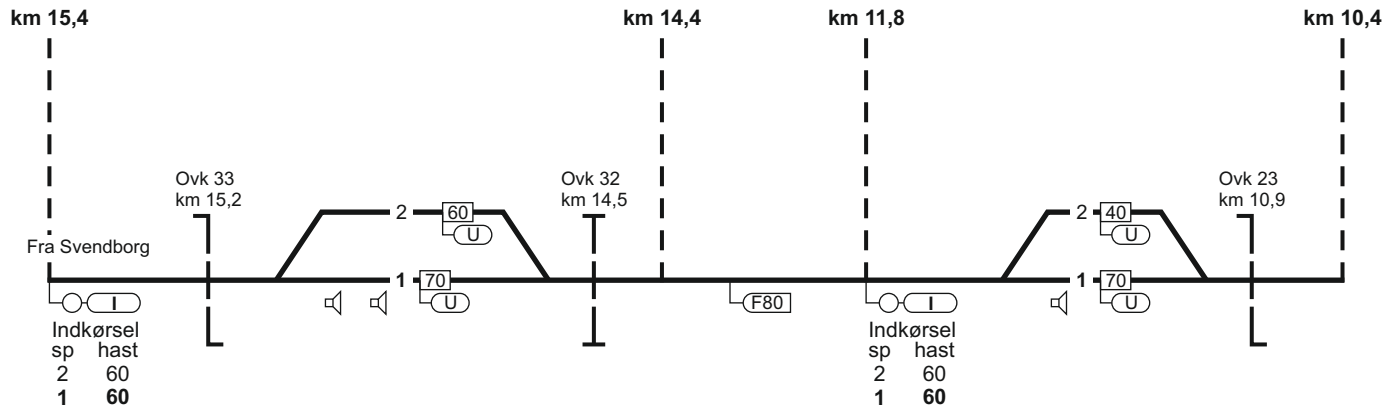

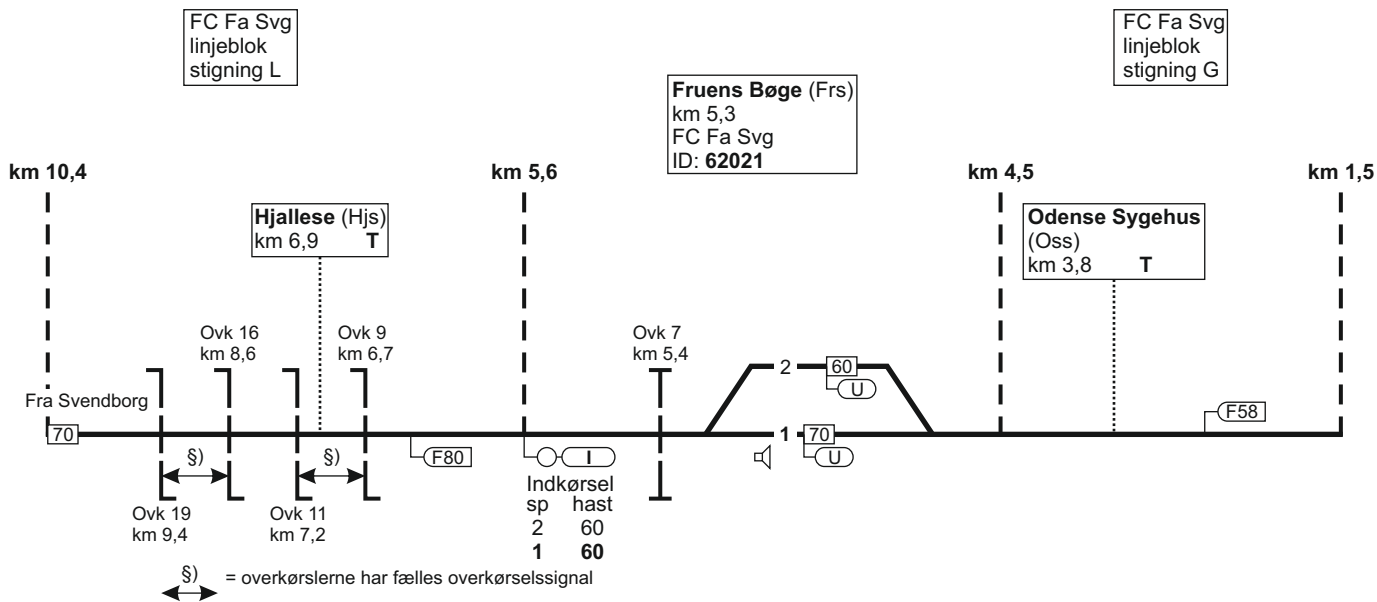

Odense (Od)
 km 160,3
 overgangsstation
 ID: 66800

km 1,5

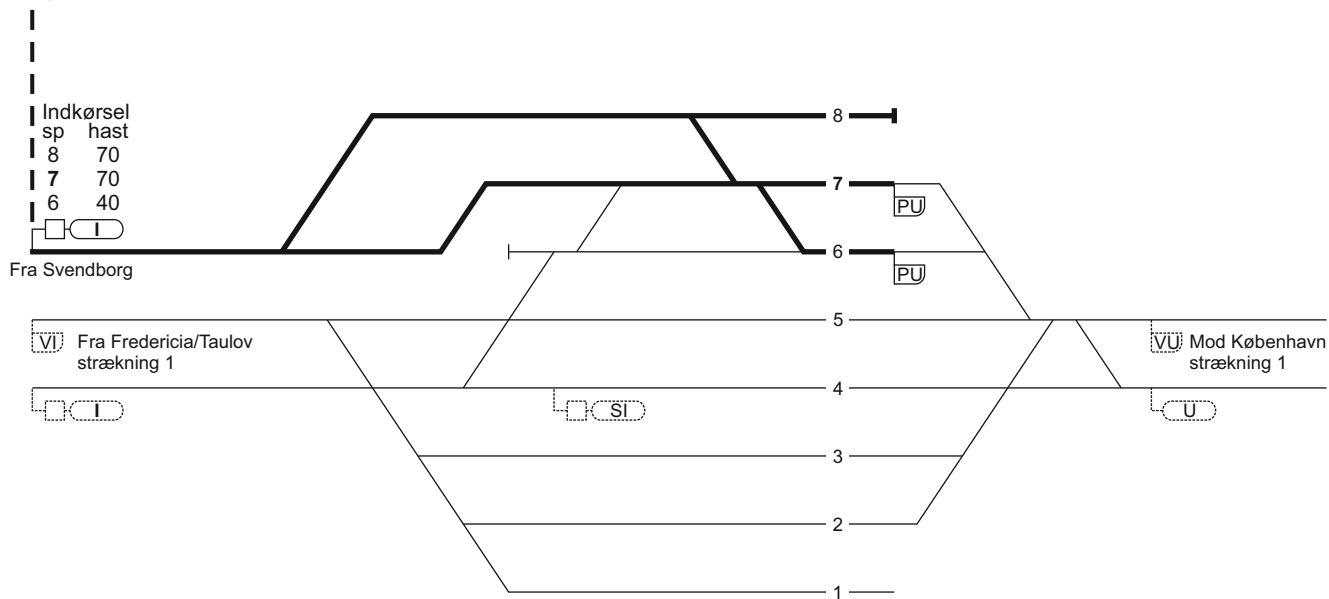

90

1,5

Togekspeditionssted 1	Togfølgestation 2	Sporbenyttelse 3	Standsningssted 4	Kmp/FC telefonnummer 5
Odense				Kmp: 82 20 11 11 eller 82 20 11 57 GSM-R: 81 99 12 68
Fredericia				FC: Od (ekskl.) - Svg 82 27 25 12 GSM-R: 81 99 12 22

23. Fredericia - (Børkop)**Strækningshastighed:**

Delstrækning	Strækningshastighed (km/t)
Fredericia - (Børkop)	160

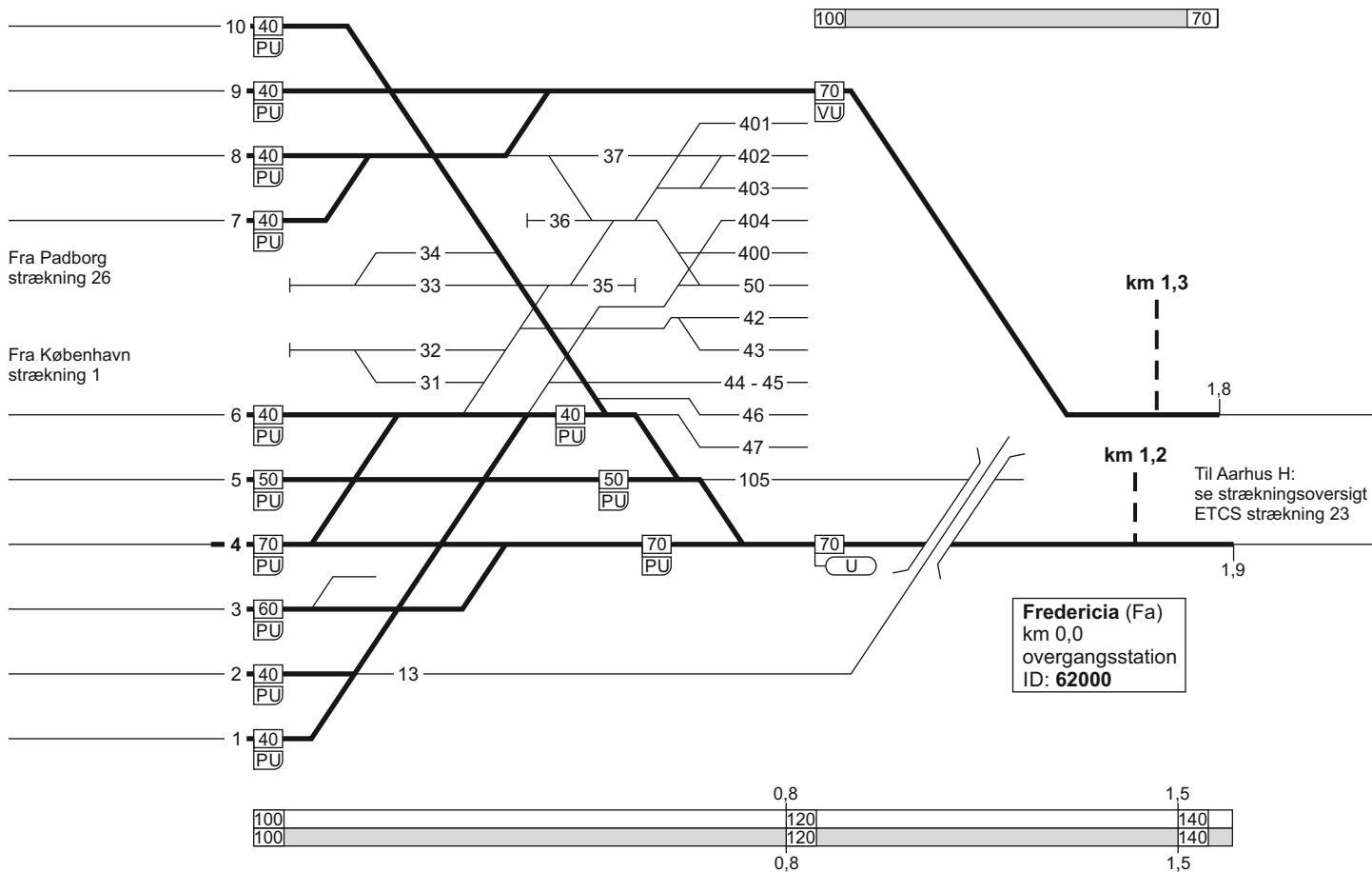

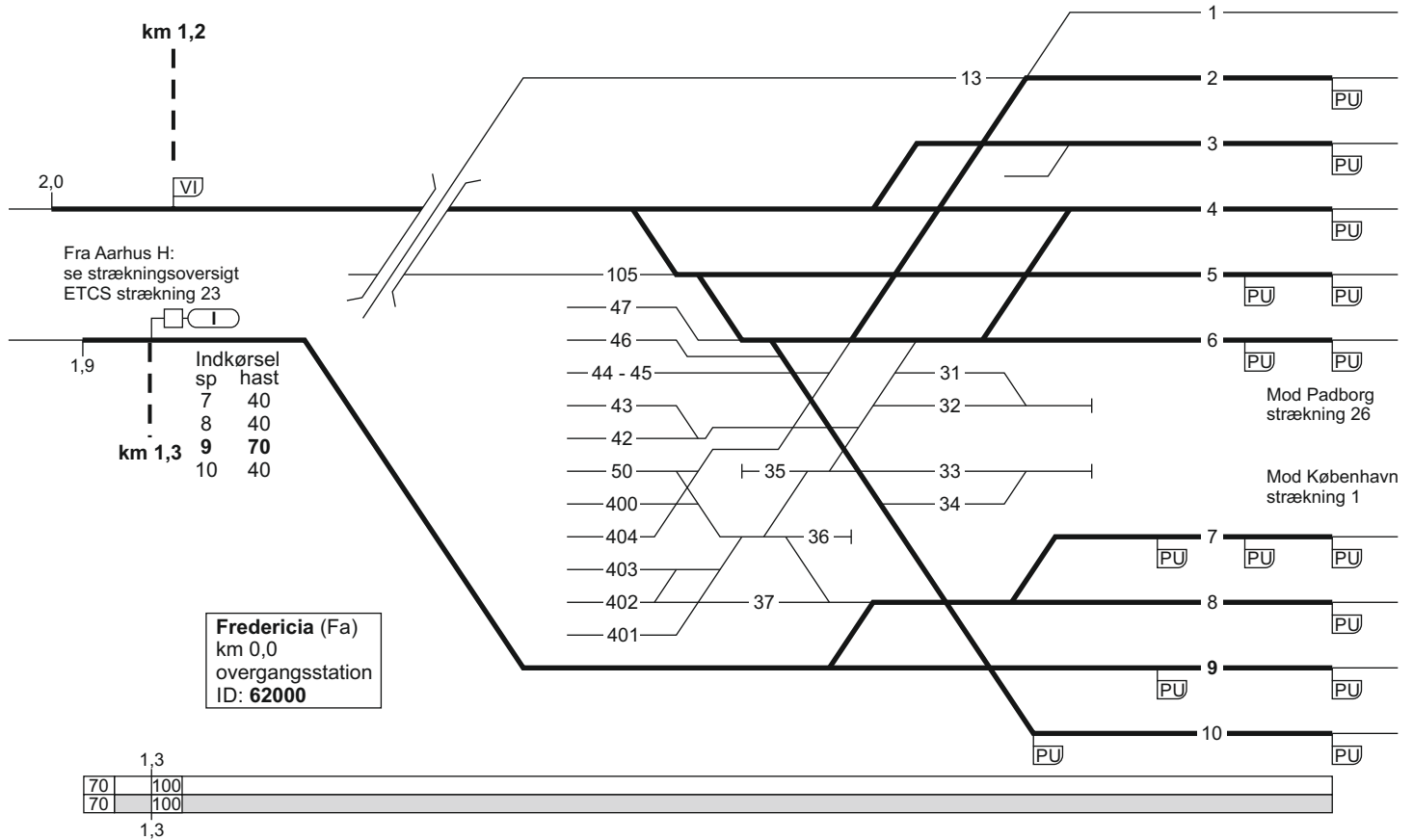

Togekspeditionssted 1	Togfølgestation 2	Sporbenyttelse 3	Standningssted 4	Kmp/FC telefonnummer 5
Fredericia			<p>Ved indkørsel fra Børkop for MF-tog, som skal sammenkobles i spor 10: Først ankommende togdel skal standse ud for standningsmærke anbragt syd for perronhallen, til højre for sporet.</p> <p>G- og M-tog skal køre helt frem til togvejens endepunkt.</p>	<p>Kmp: 82 27 23 05</p> <p>GSM-R: 81 99 12 20</p> <p>FC: Fa - Bk (ekskl.) 82 27 23 05</p> <p>GSM-R: Fa - Bk (ekskl.) 81 99 12 20</p>

26. Fredericia - Padborg**Strækningshastighed:**

Delstrækning	Strækningshastighed (km/t)
Fredericia - Vojens	160
Vojens - Tinglev	180
Tinglev - Padborg	120

Fredericia (Fa)
 km 0,0
 overgangsstation
 ID: 62000

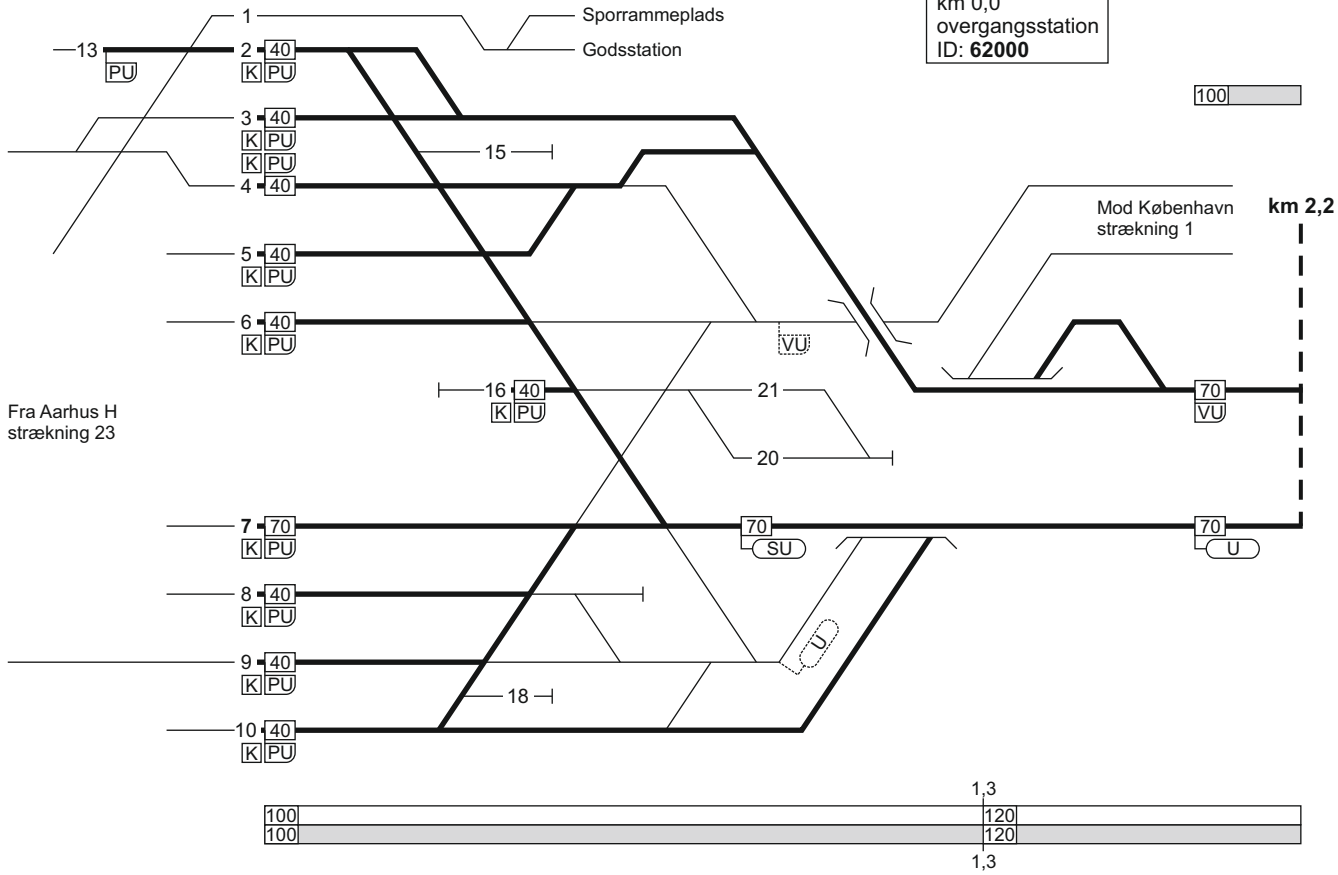

FC Fa Vest
linjeblok
stigning H

Taulov (TI)
km 8,6
overgangsstation
FC Fa Vest
ID: 66900

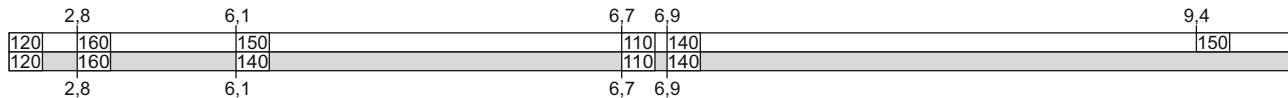
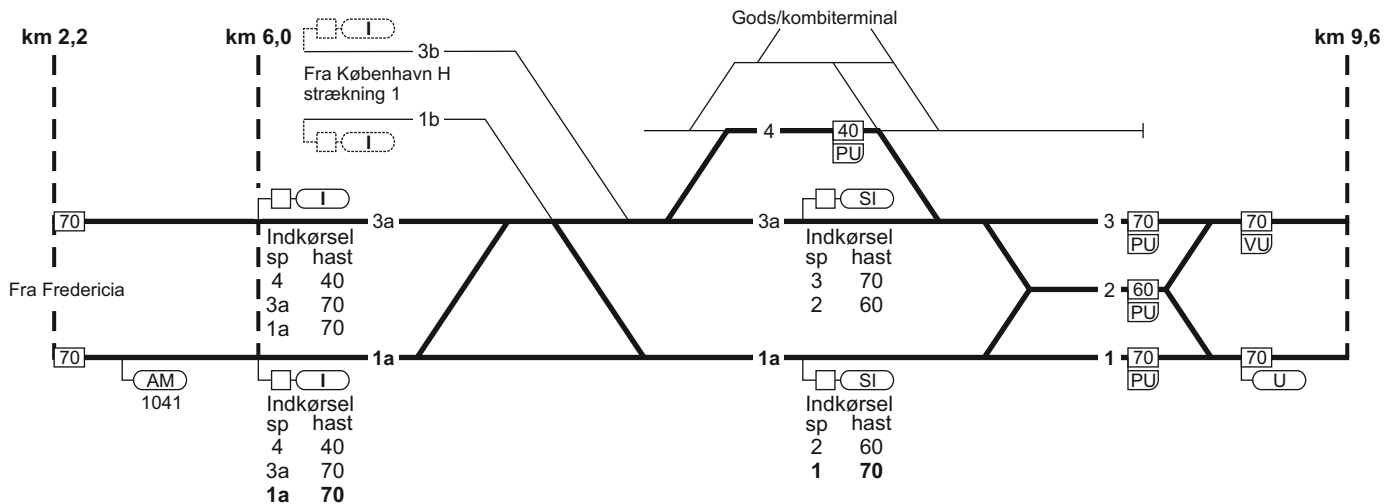
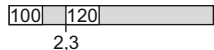

FC Fa Vest
linjeblok
stigning K

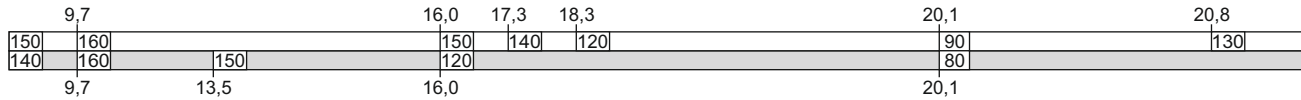
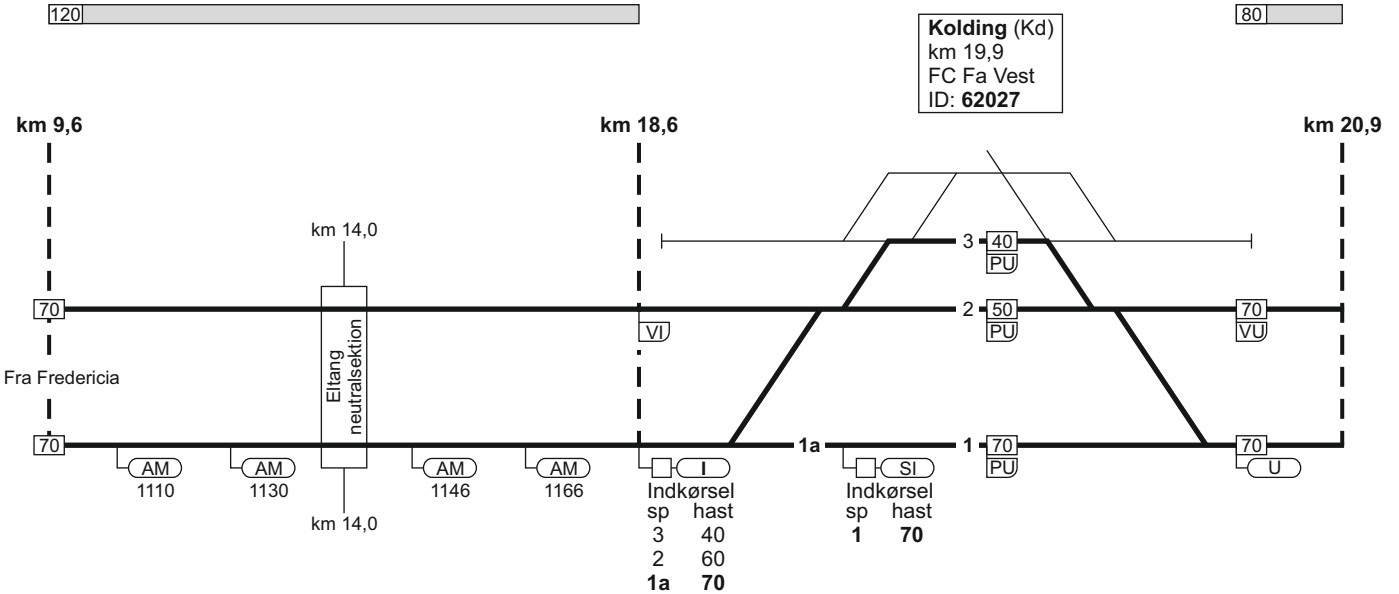

FC Fa Vest
linjeblok
stigning H

Lunderskov (Lk)
km 32,8
overgangsstation
FC Fa Vest
ID: 62046

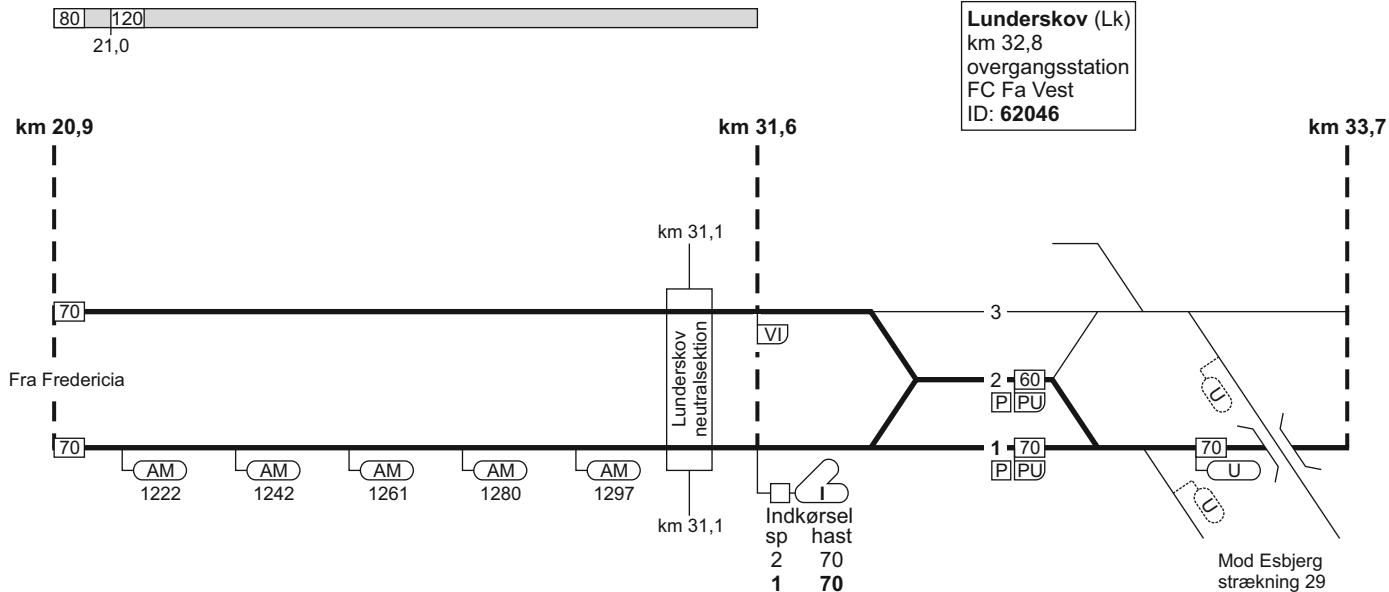

21,0	25,9	26,7	29,4	30,0
130	160	150	160	150
80	160	140	160	140
21,0	25,9	26,7	29,4	30,0

FC Fa Syd
linjeblok
(kun højre spor)
stigning H

FC Fa Syd
linjeblok / vekselspor
stigning J

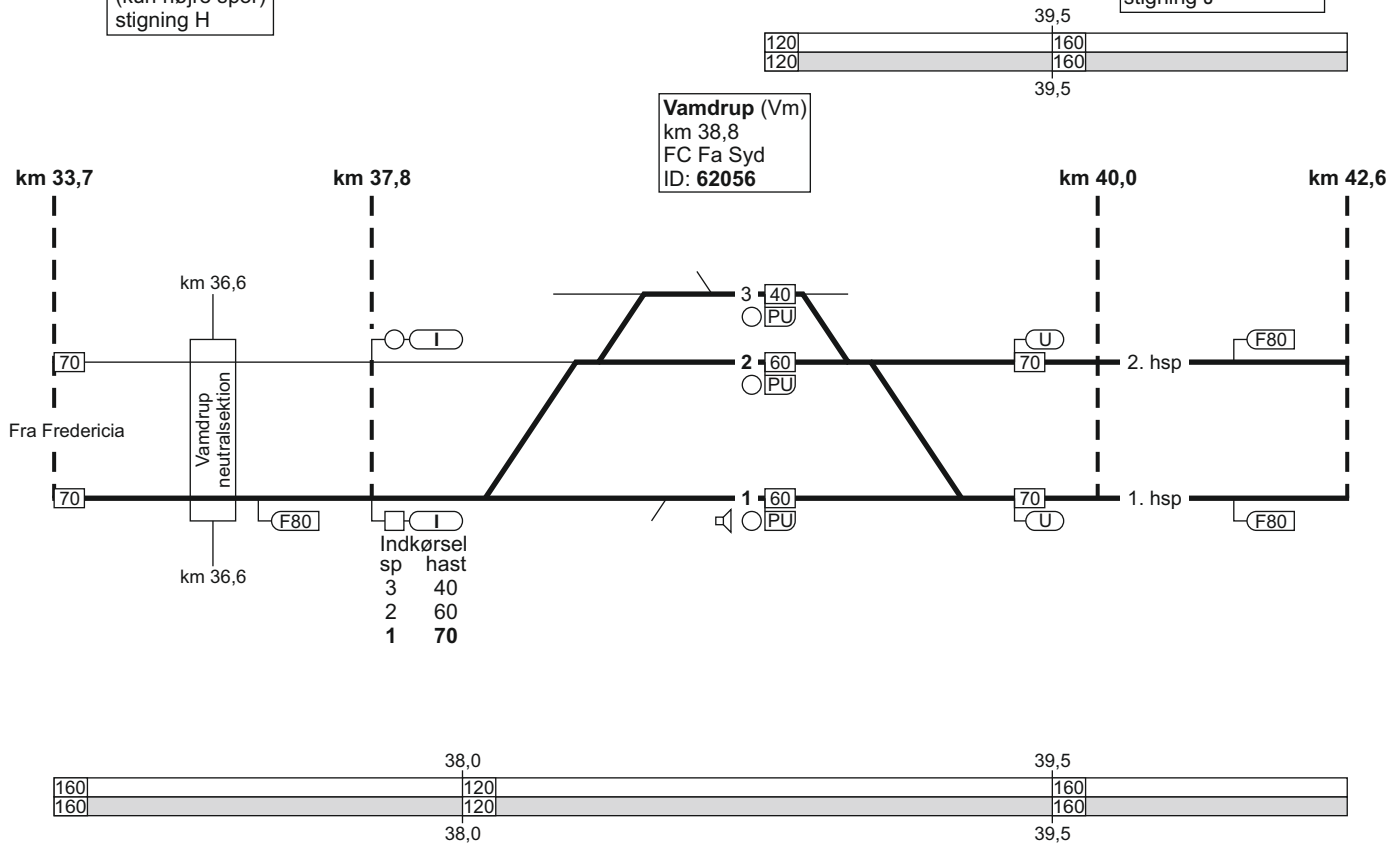

FC Fa Syd
linjeblok / vekselspor
stigning K

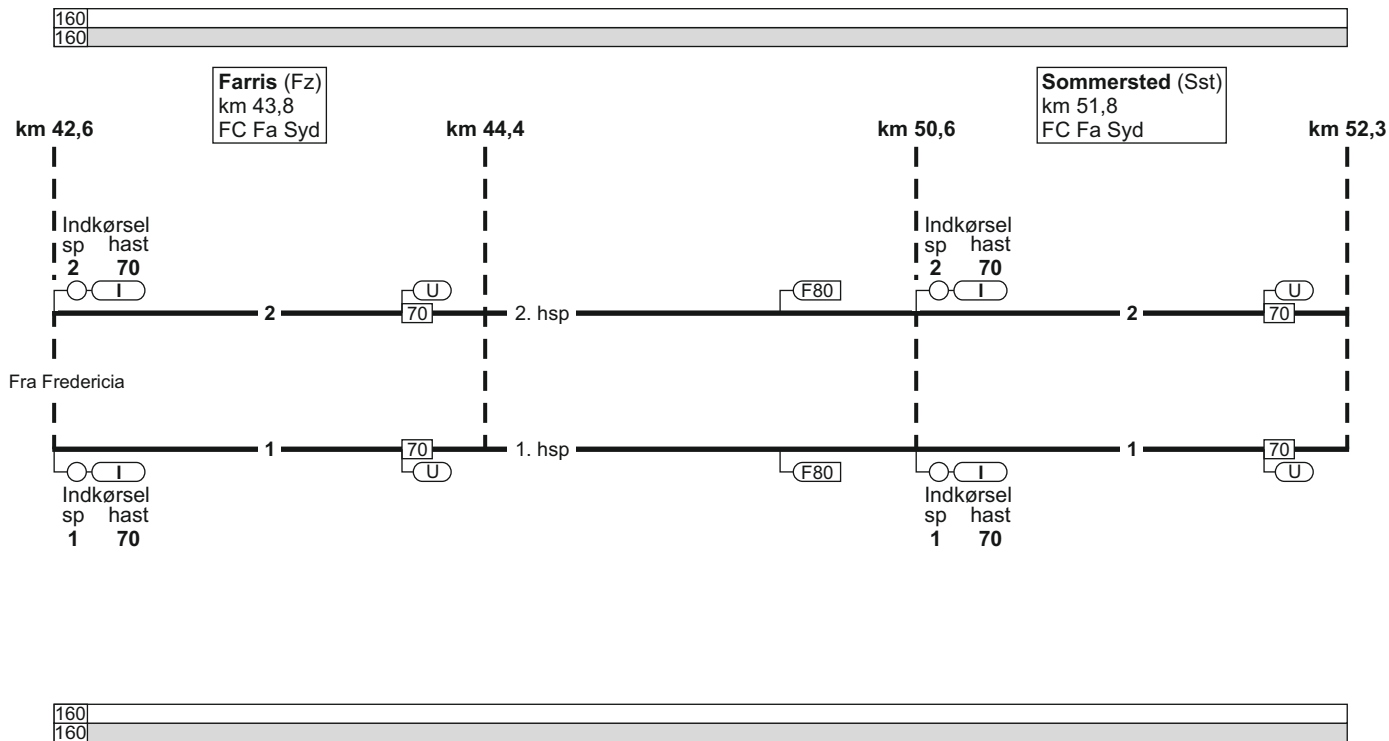

FC Fa Syd
linjeblok / vekselspor
stigning J

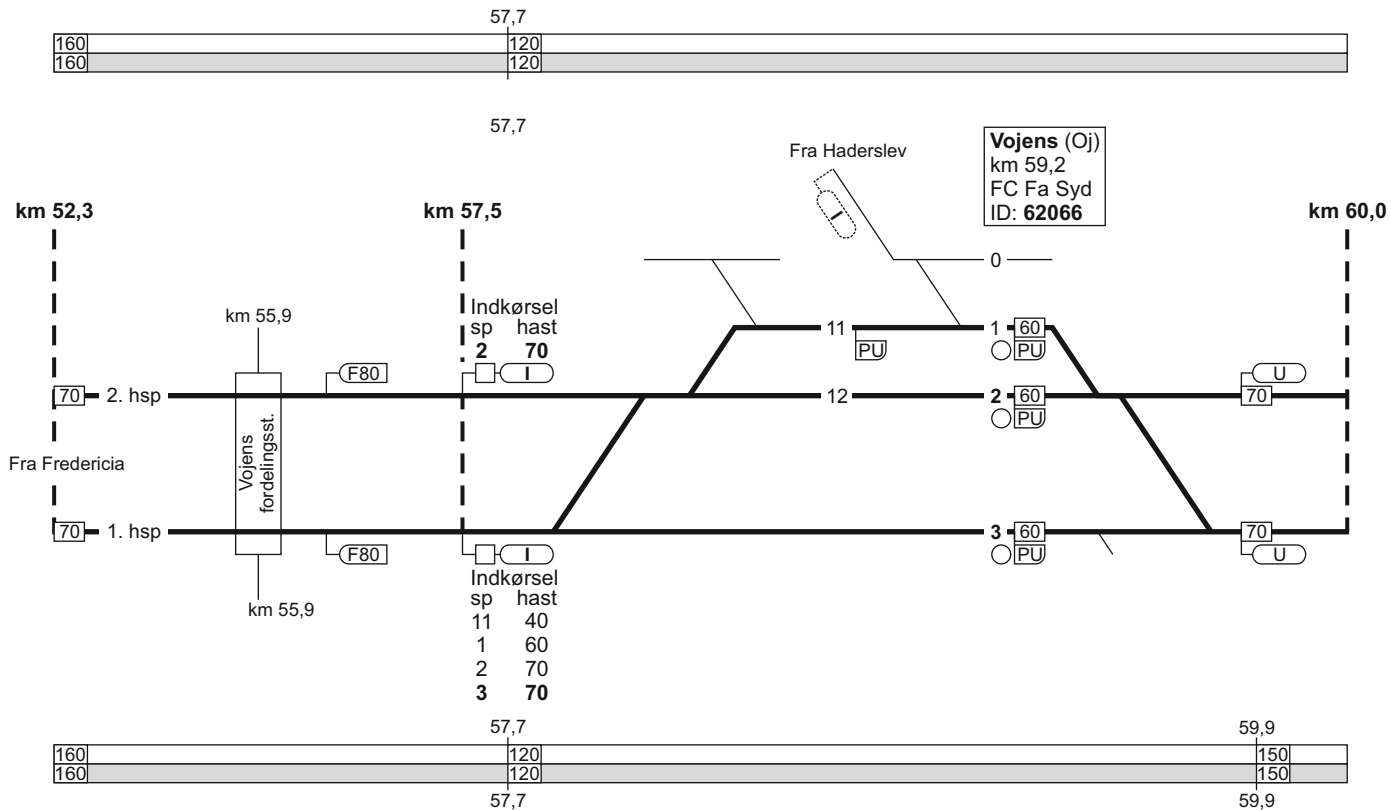

FC Fa Syd
linjeblok / vekselspor
stigning J

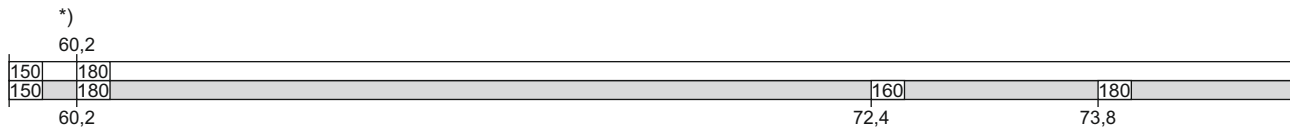
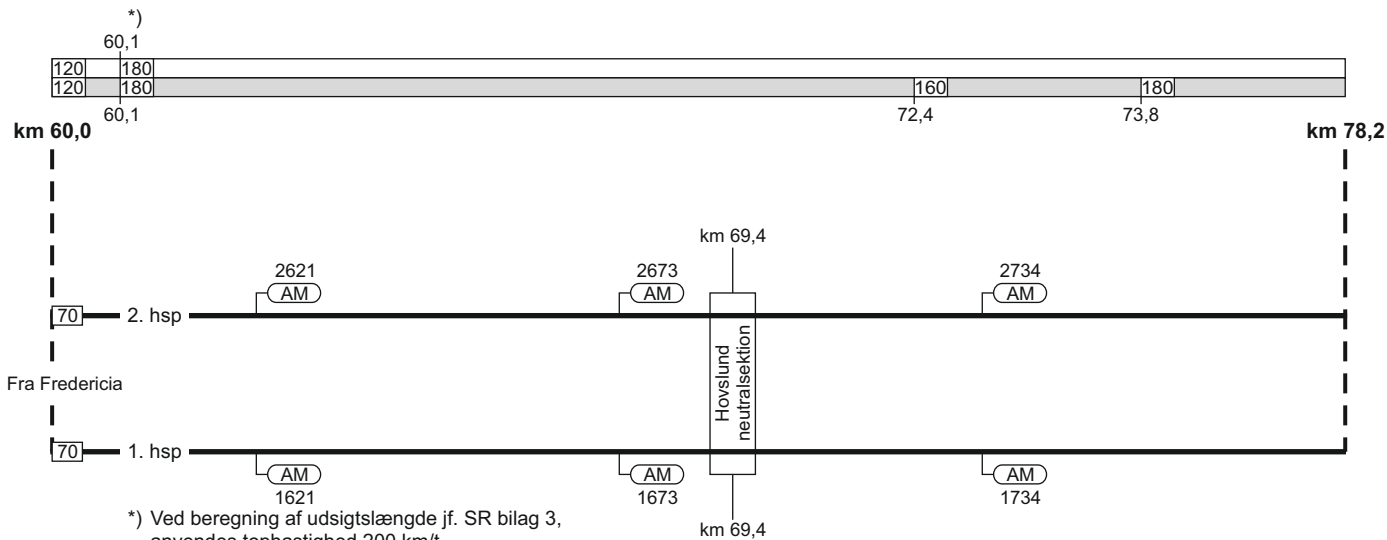

FC Fa Syd
linjeblok / vekselspor
stigning L

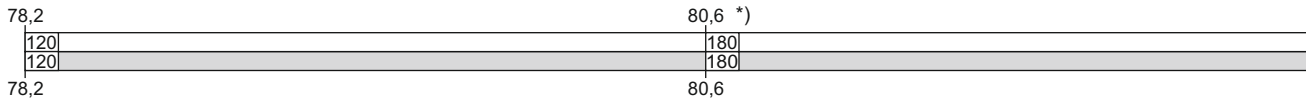
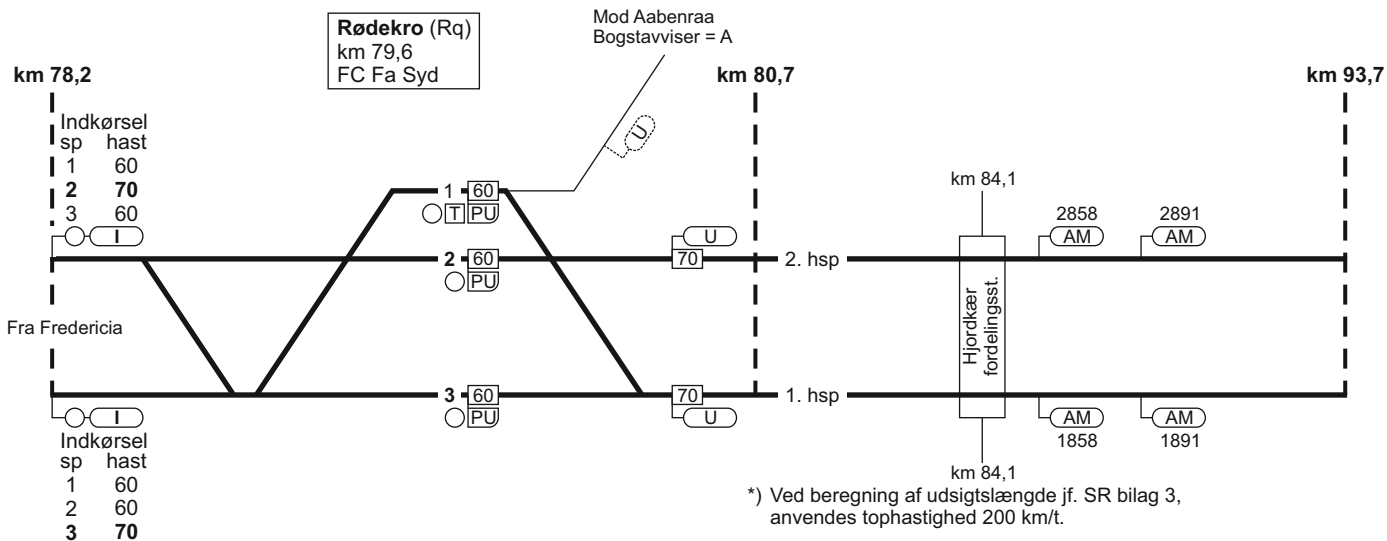
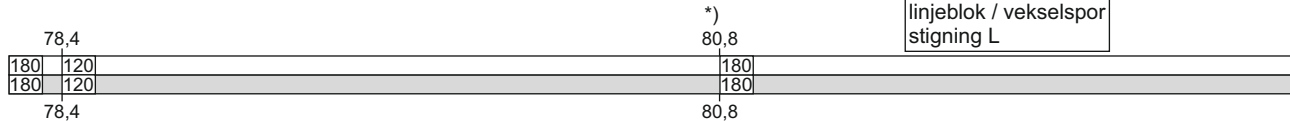

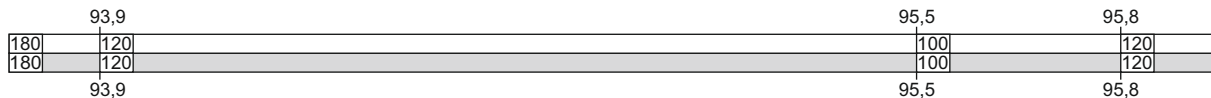

km 93,7

Indkørsel	sp	hast
5	60	
4	60	
3	70	
2	60	
1	60	

Tinglev (Te)
 km 95,3
 overgangsstation
 FC Fa Syd
 ID: 67600

5 - 40
 P PU

4 - 40
 P PU

3 - 70
 P PU

2 - 70
 P PU

1 - 40
 P PU

70
 PU

70
 U

km 96,2

Mod Sønderborg
 strækning 28

Ovk 200
 km 95,9

Fra Fredericia

Indkørsel	sp	hast
5	60	
4	60	
3	60	
2	70	
1	60	

93,7



93,7

FC Fa Syd
linjeblok
stigning L

FC Fa Syd
linjeblok
stigning K

Vejbæk (Vk)
km 102,9
FC Fa Syd

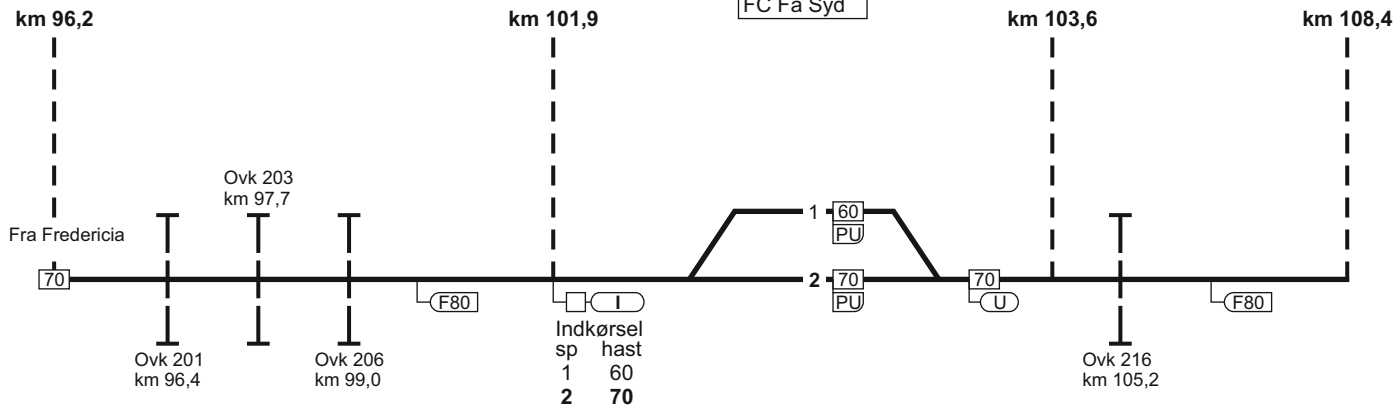

Padborg (Pa)
 km 109,7
 overgangsstation
 ID: 67400

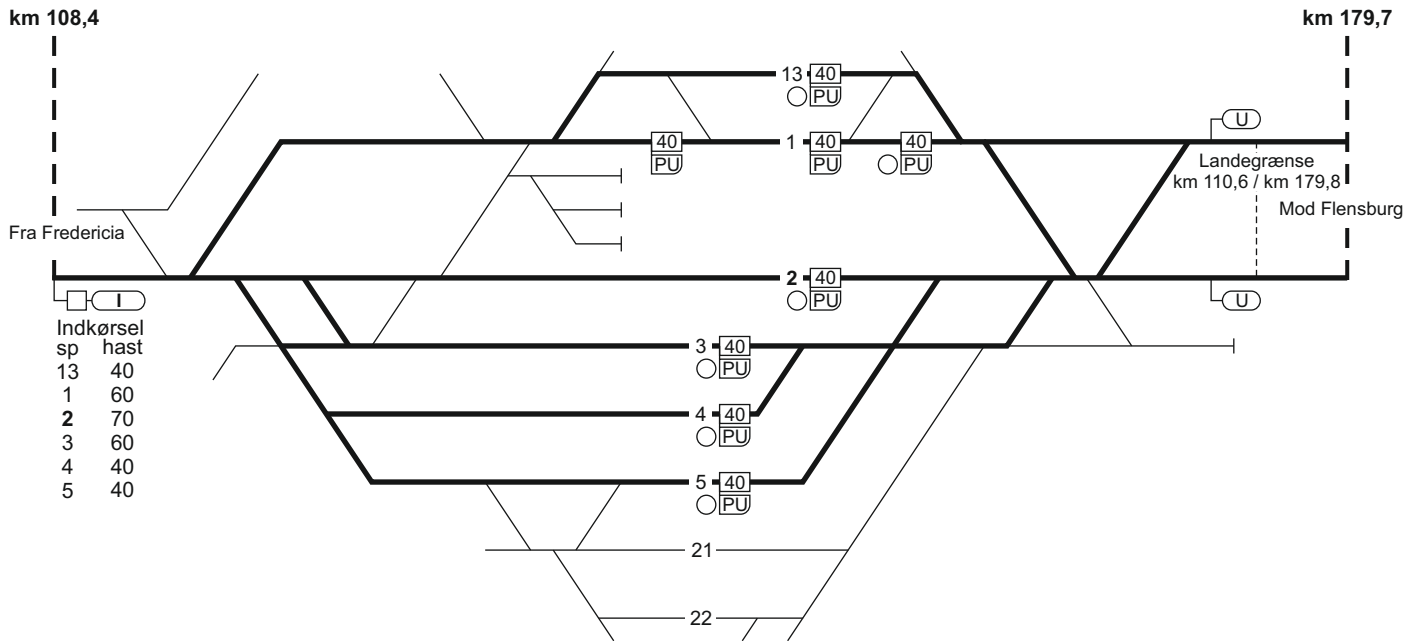

Indkørsel

sp	hast
13	40
1	60
2	70
3	60
4	40
5	40



Padborg (Pa)
 km 109,7
 overgangsstation
 ID: 67400

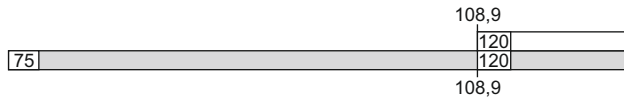
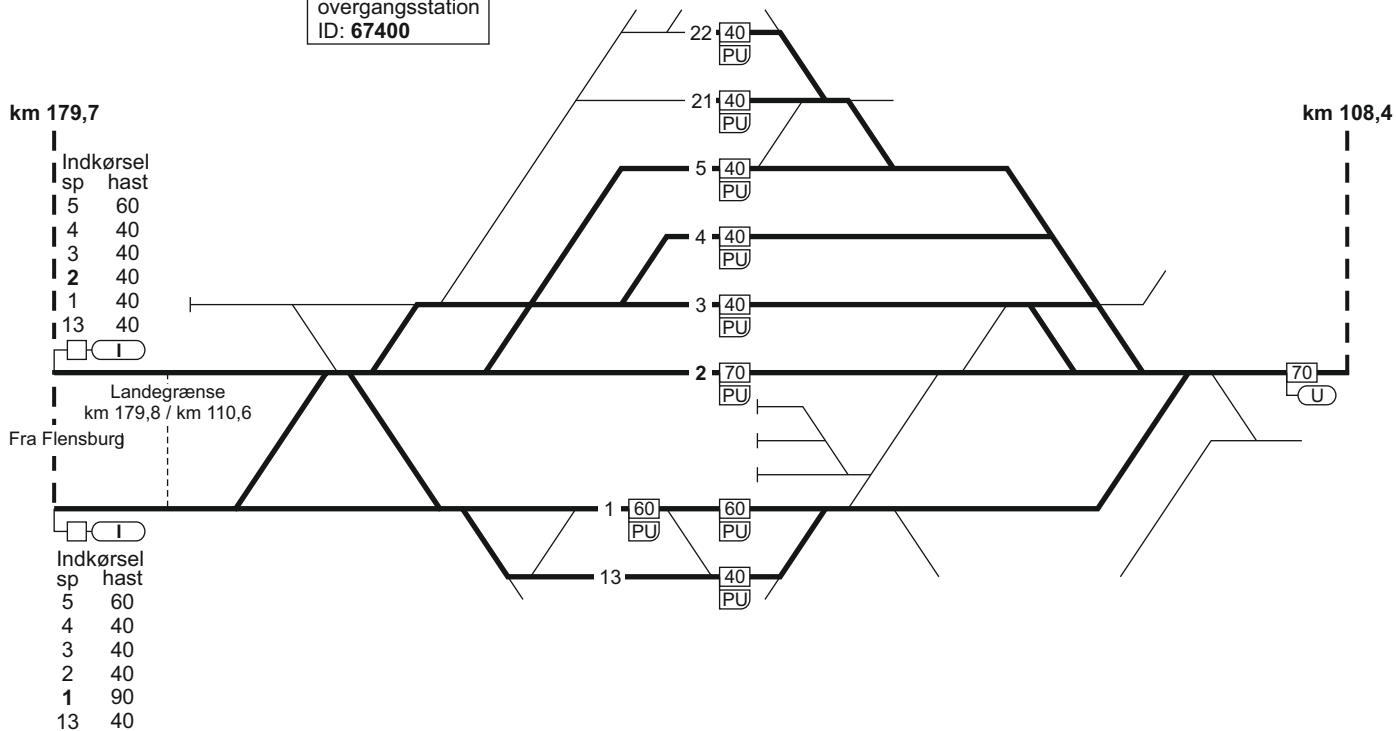

FC Fa Syd
linjeblok
stigning M

FC Fa Syd
linjeblok
stigning L

Vejbæk (Vk)
km 102,9
FC Fa Syd

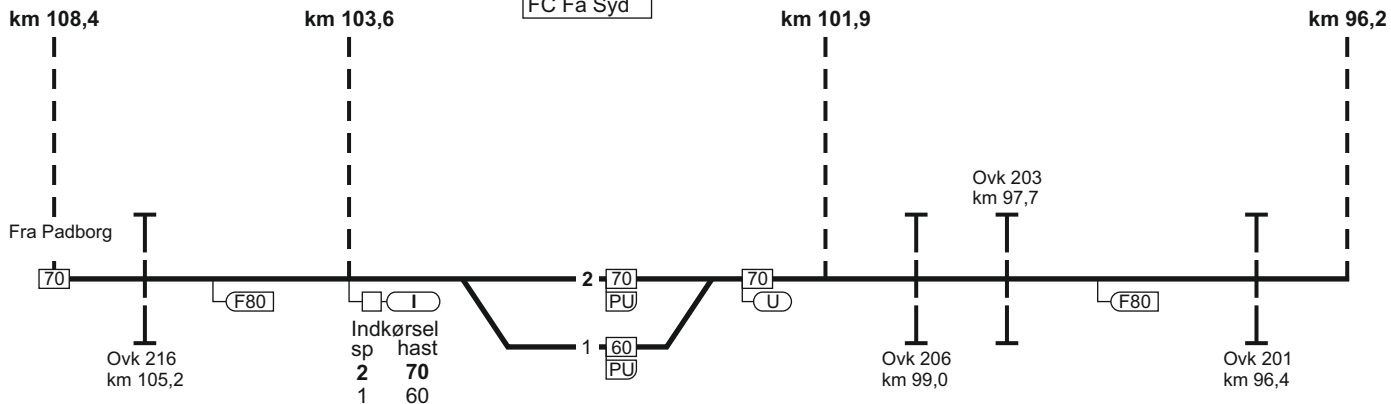

120
120

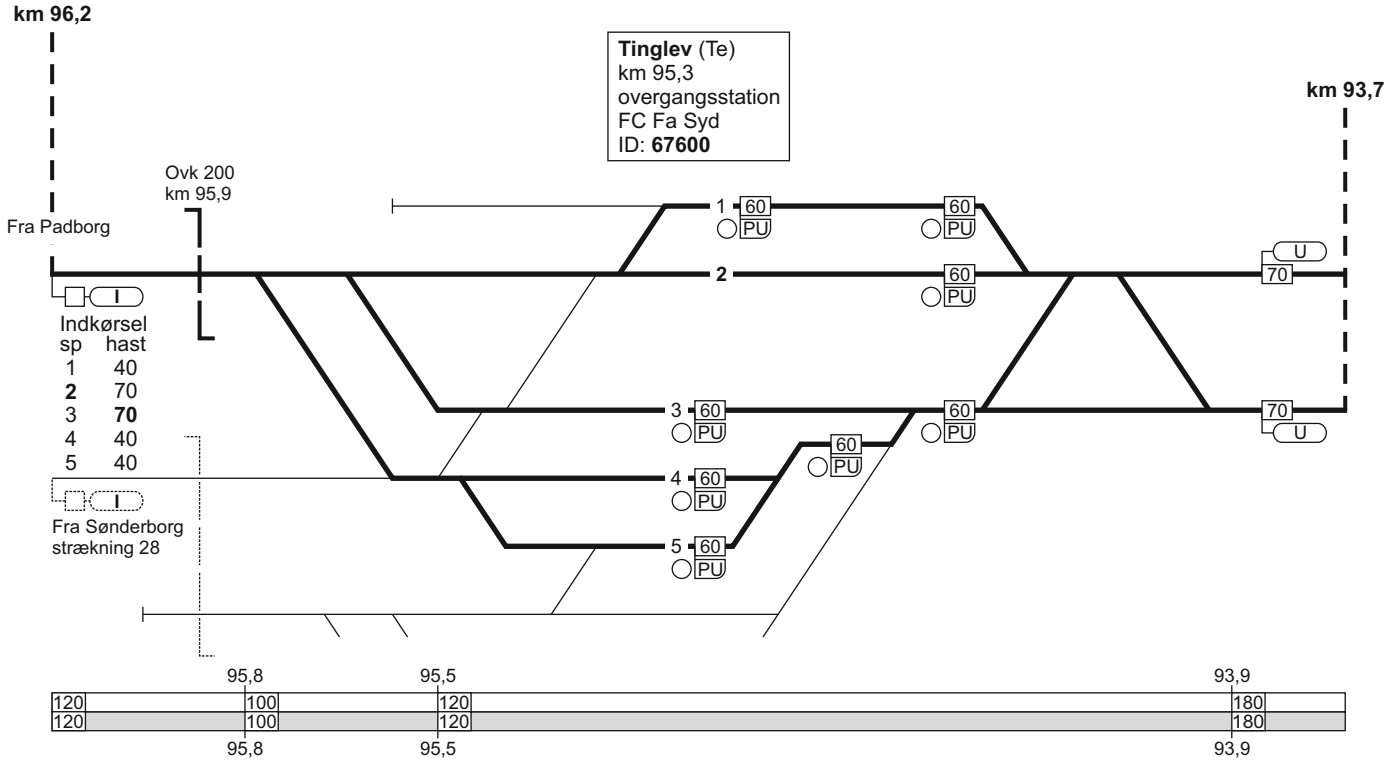

FC Fa Syd
linjeblok / vekselspor
stigning K

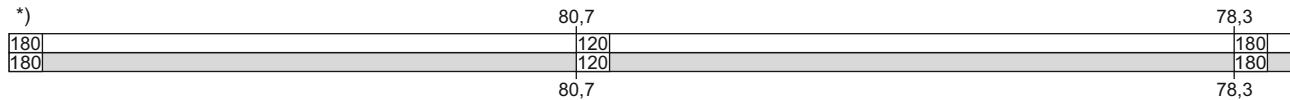
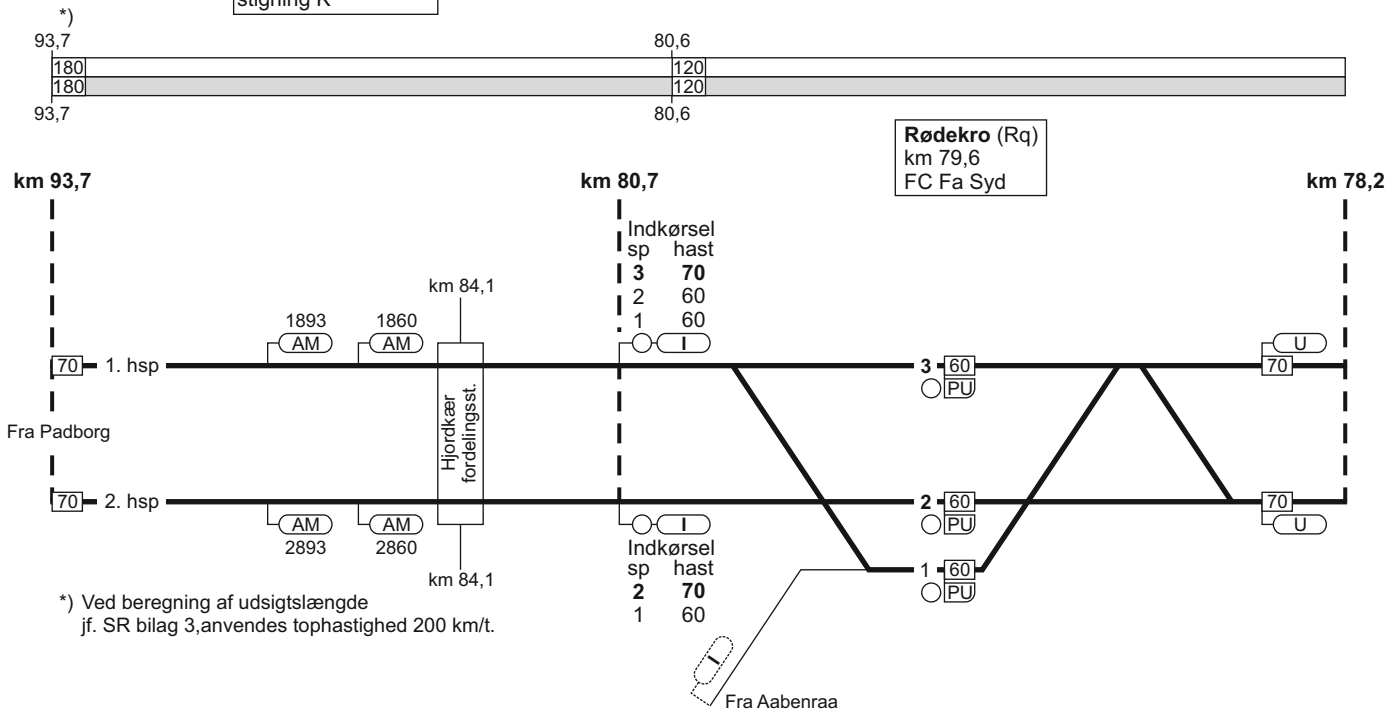

FC Fa Syd
linjeblok / vekselspor
stigning L

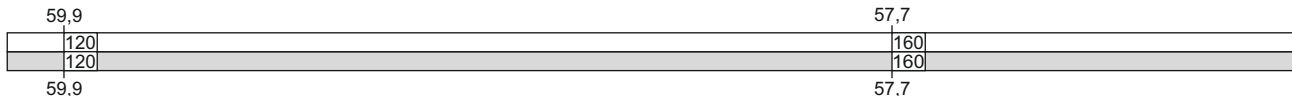

km 60,0

Indkørsel	sp	hast
3		70
2		60
12		60
1		40
11		60

Vojens (Oj)
km 59,2
FC Fa Syd
ID: 62066

km 57,5

km 52,3

Fra Padborg

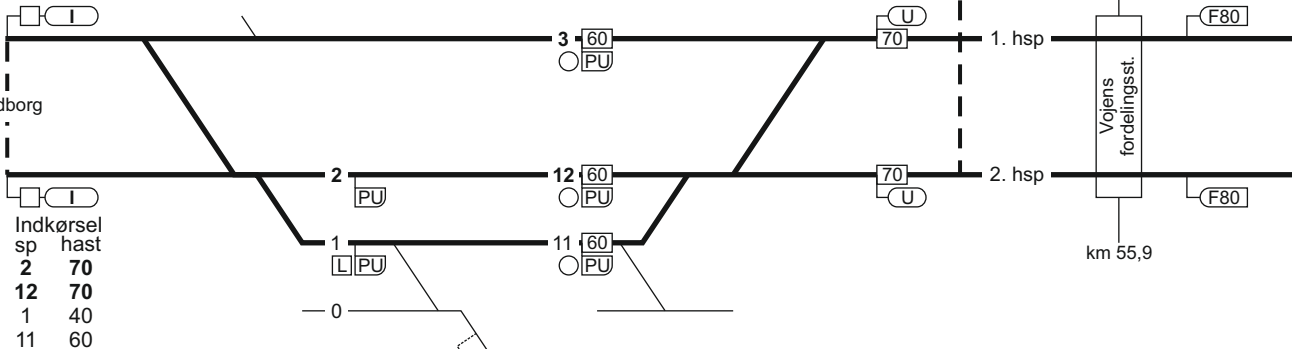

Indkørsel	sp	hast
2		70
12		70
1		40
11		60

Mod Haderslev
bogstaviser = H

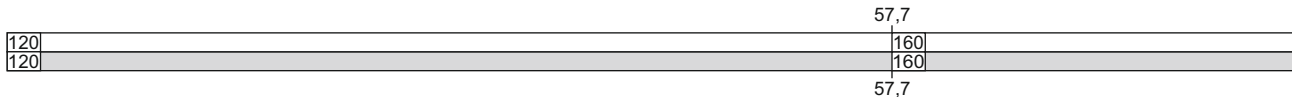

FC Fa Syd
linjeblok / vekselspor
stigning J

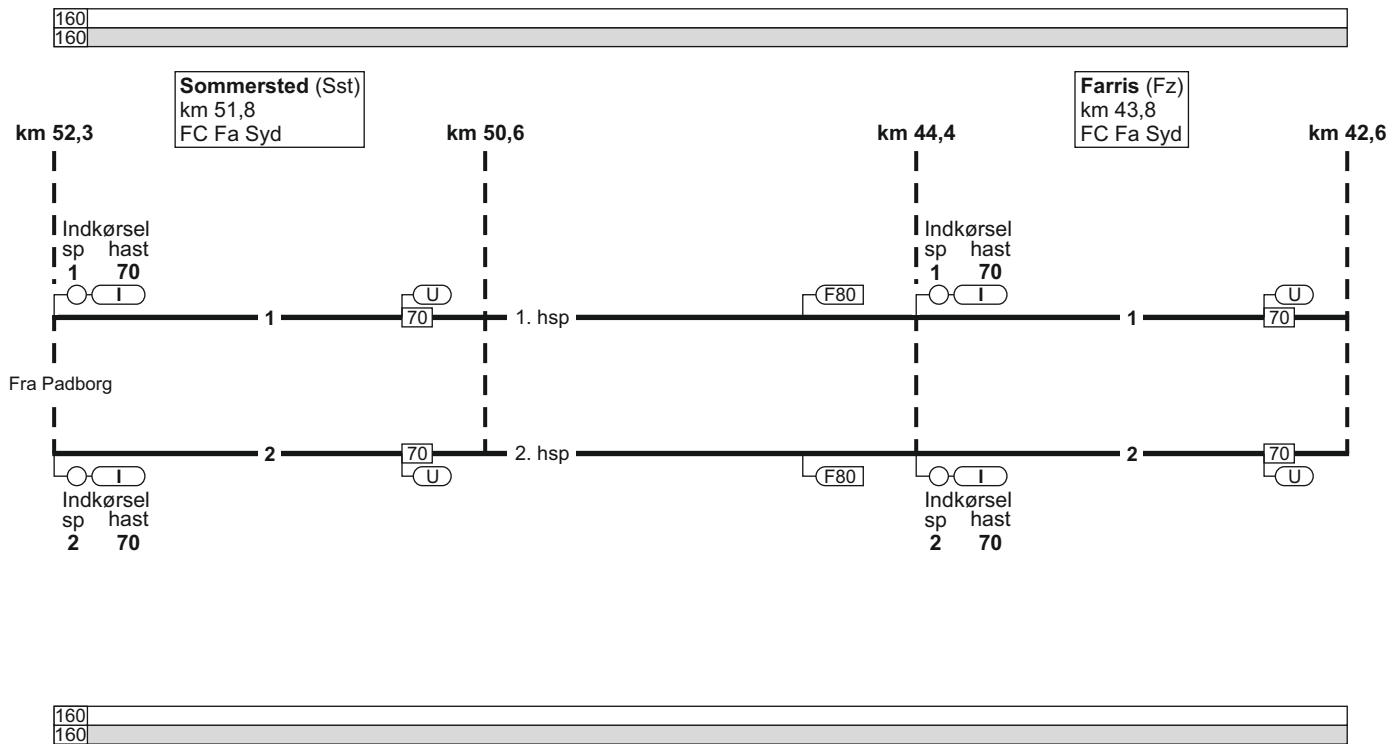

FC Fa Syd
linjeblok / vekselspor
stigning J

FC Fa Syd
linjeblok
(kun højre spor)
stigning J

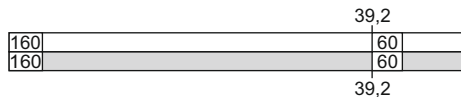

Vamdrup (Vm)
km 38,8
FC Fa Syd
ID: 62056

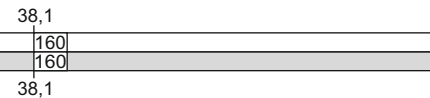
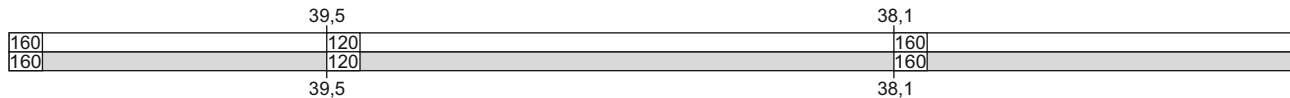
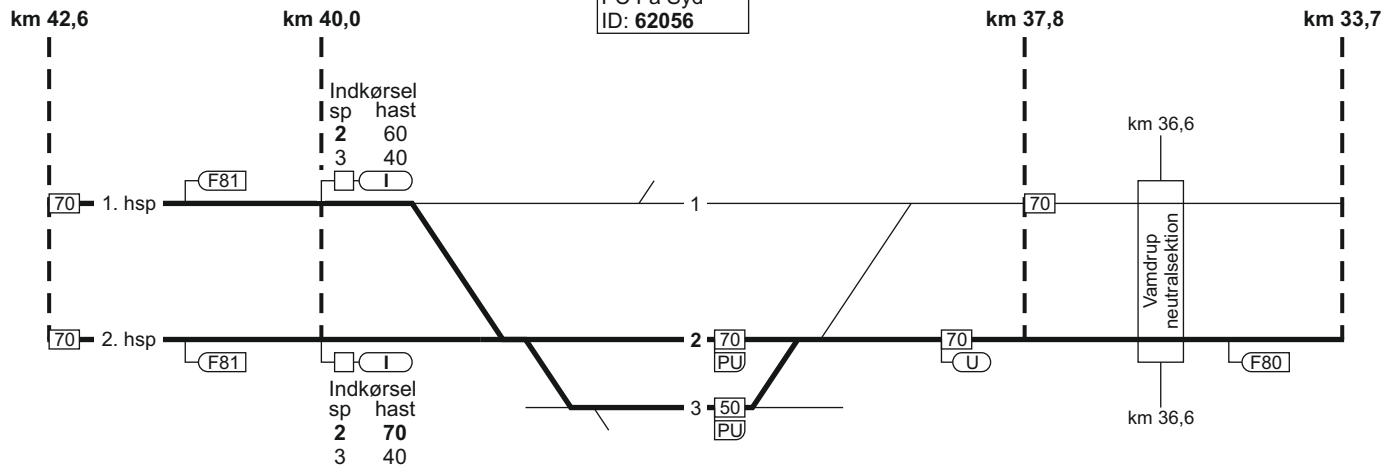

FC Fa Vest
linjeblok
stigning J

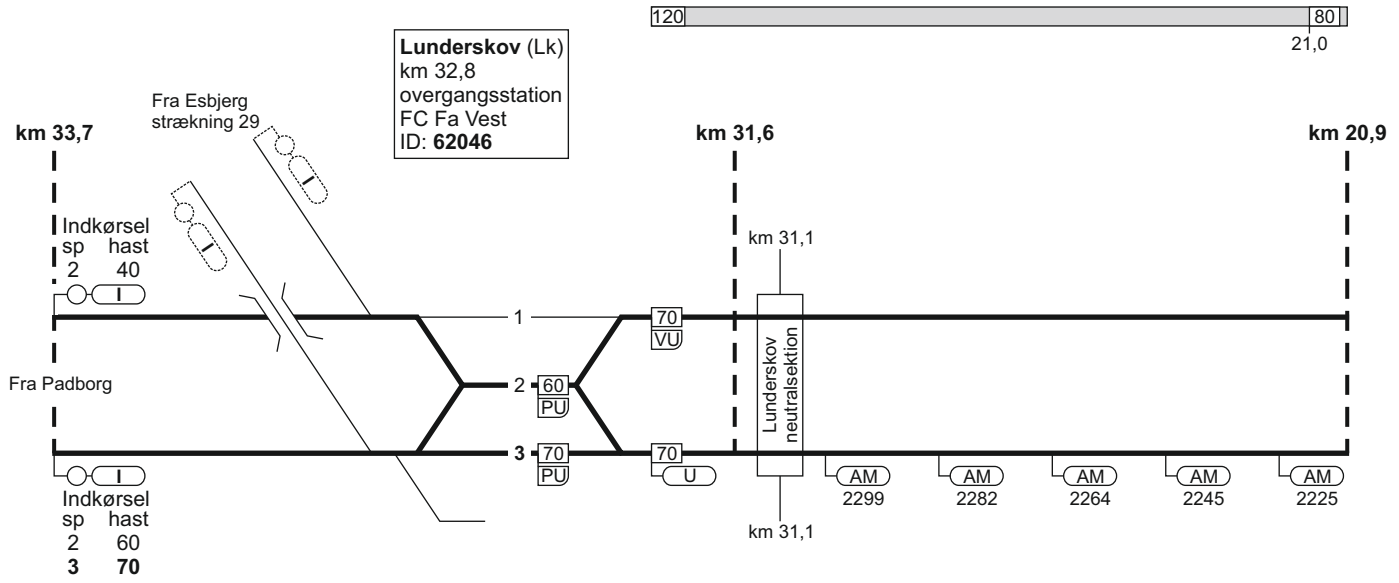

Lunderskov (Lk)
km 32,8
overgangsstation
FC Fa Vest
ID: 62046



km 33,7

Indkørsel
sp hast
2 40

Fra Padborg

Indkørsel
sp hast
2 60
3 70

km 31,6

km 31,1

km 20,9

km 31,1

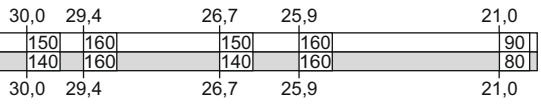

FC Fa Vest
linjeblok
stigning H

Kolding (Kd)
km 19,9
FC Fa Vest
ID: 62027

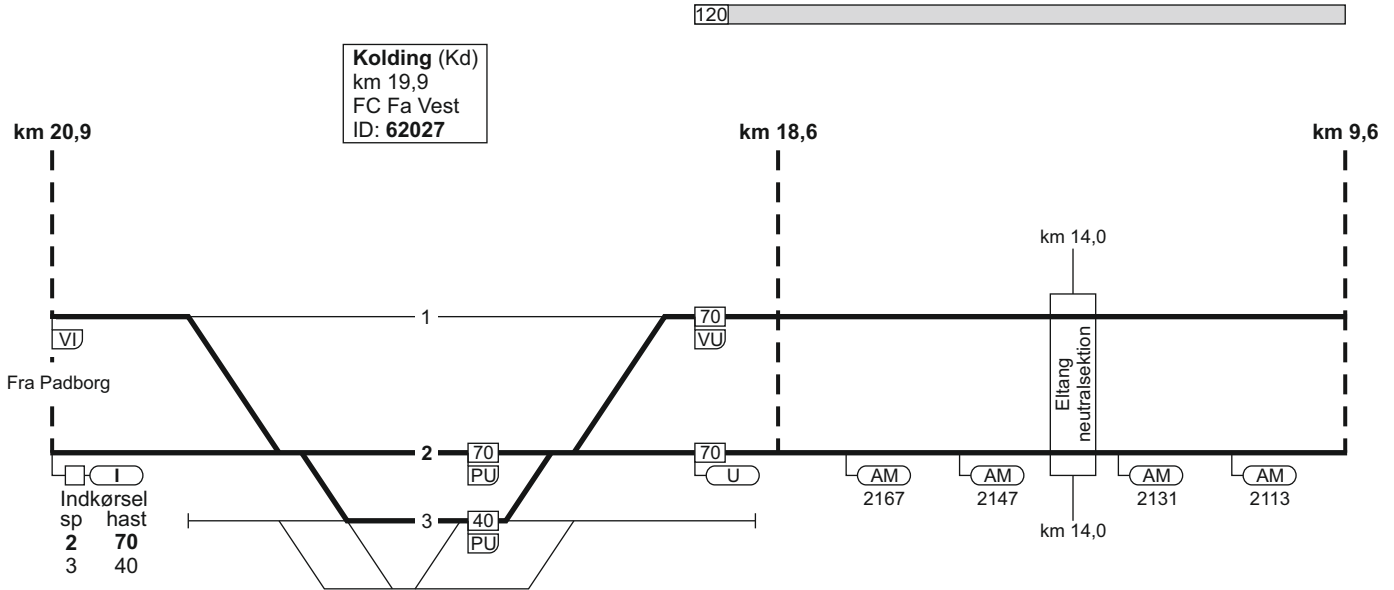

	20,1		18,3	17,3	16,0		9,7
90	120		140	150	160		150
80	120				150		140
	20,1		16,0		13,5		9,7

FC Fa Vest
linjeblok
stigning K

Taulov (TI)
km 8,6
overgangsstation
FC Fa Vest
ID: 66900

120

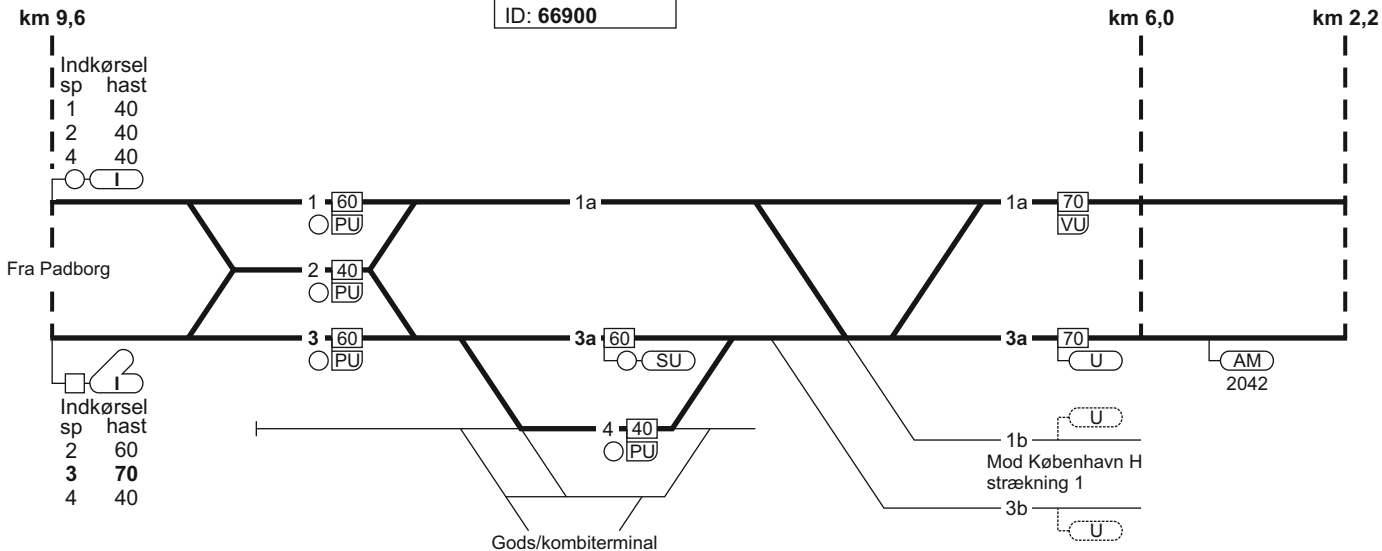

	8,7	8,2		6,2	2,8	2,3
150	140	110		160	120	100
140		110		160	120	100
		8,2		6,2	3,5	2,3

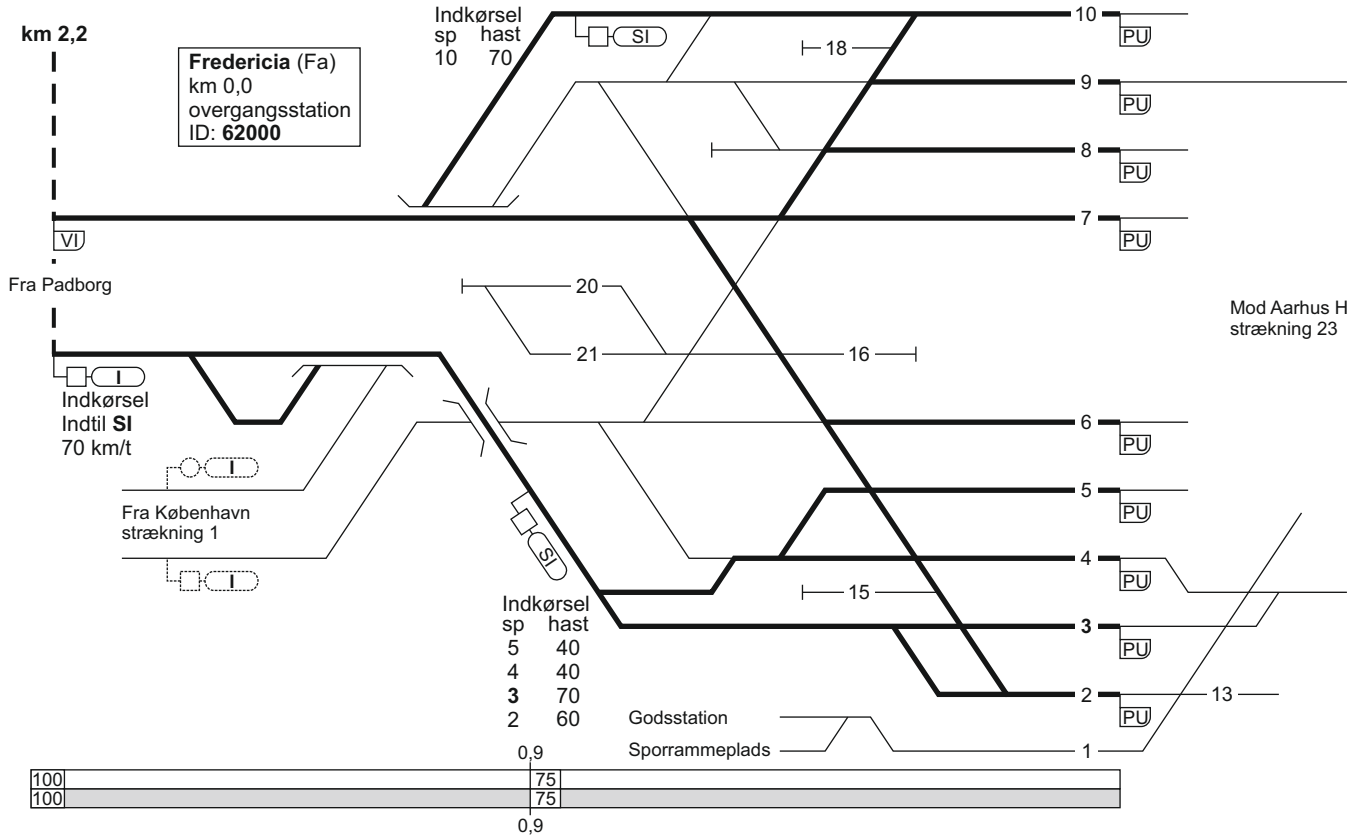

Togekspeditionssted 1	Togfølgestation 2	Sporbenyttelse 3	Standsningssted 4	Kmp/FC telefonnummer 5
Fredericia			<p>Ved indkørsel fra Taulov for MF-tog, som skal sammenkobles i spor 10: Først ankommende togdel skal standse ud for standsningsmærke anbragt til venstre for sporet.</p> <p>G- og M-tog skal køre helt frem til togvejens endepunkt.</p>	<p>Kmp: 82 27 23 05</p> <p>GSM-R: 81 99 12 20</p> <p>FC: Fa - Lk 82 27 25 15</p> <p>GSM-R: 81 99 12 24</p> <p>Lk (ekskl.) - Pa (ekskl.) 82 27 25 14</p> <p>GSM-R: 81 99 12 26</p>
Taulov				<p>GSM-R: 81 99 12 69</p>

Togekspeditionssted 1	Togfølgestation 2	Sporbenyttelse 3	Standingssted 4	Kmp/FC telefonnummer 5
Kolding			<p>Ved indkørsel fra Lunderskov Tog som skal sammenkobles i spor 2: Først ankommende togdel skal standse ud for «200-metermærket» (SR-mærke 17.20.), hvis togdelen består af 1 togsæt.</p> <p>Først ankommende togdel skal standse ud for «S-mærket» (SR-mærke 17.18.), hvis togdelen består af 2 togsæt.</p> <p>Ved indkørsel fra Taulov Tog som skal sammenkobles i spor 2: Tog skal standse umiddelbart foran Dv-signal 21.</p>	GSM-R: 81 99 12 27
Tinglev				GSM-R: 81 99 12 76
Padborg			<p>Ved indkørsel fra Syd Tog fremført af MF, som skal ekspederes ved perron i spor 1: Tog skal standse ud for «S-mærket» (SR-mærke 17.18.).</p>	<p>Kmp: 82 27 28 11</p> <p>GSM-R: 81 99 12 74</p>

28. Sønderborg - Tinglev

Strækningshastighed:

Delstrækning	Strækningshastighed (km/t)
Sønderborg - Tinglev	100

Sønderborg (Sdb)
km 0,0
FC Fa Syd

FC Fa Syd
linjeblok
stigning F

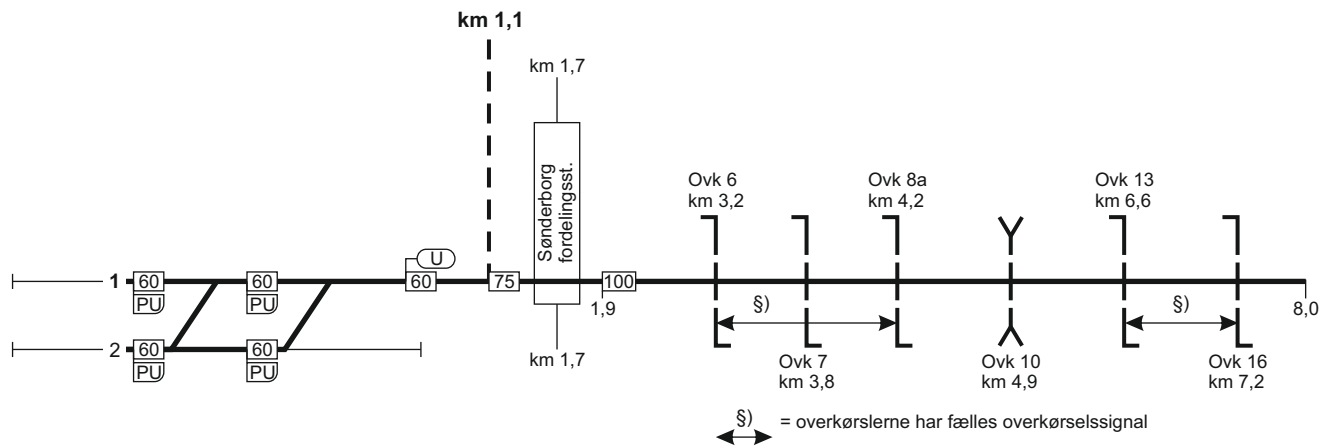

FC Fa Syd
linjeblok
stigning F

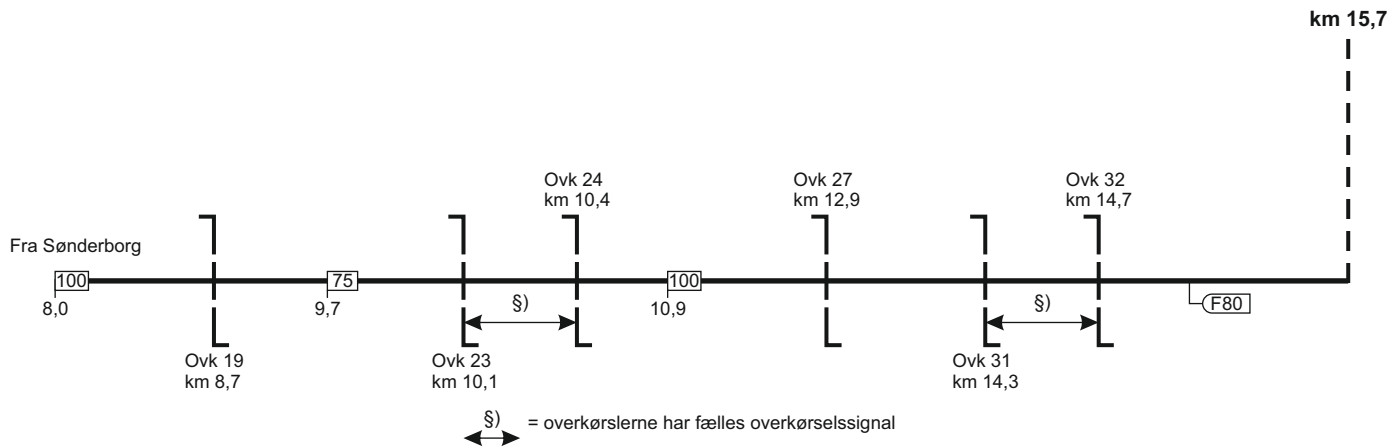

Gråsten (Gst)
km 16,3
FC Fa Syd

FC Fa Syd
linjeblok
stigning E

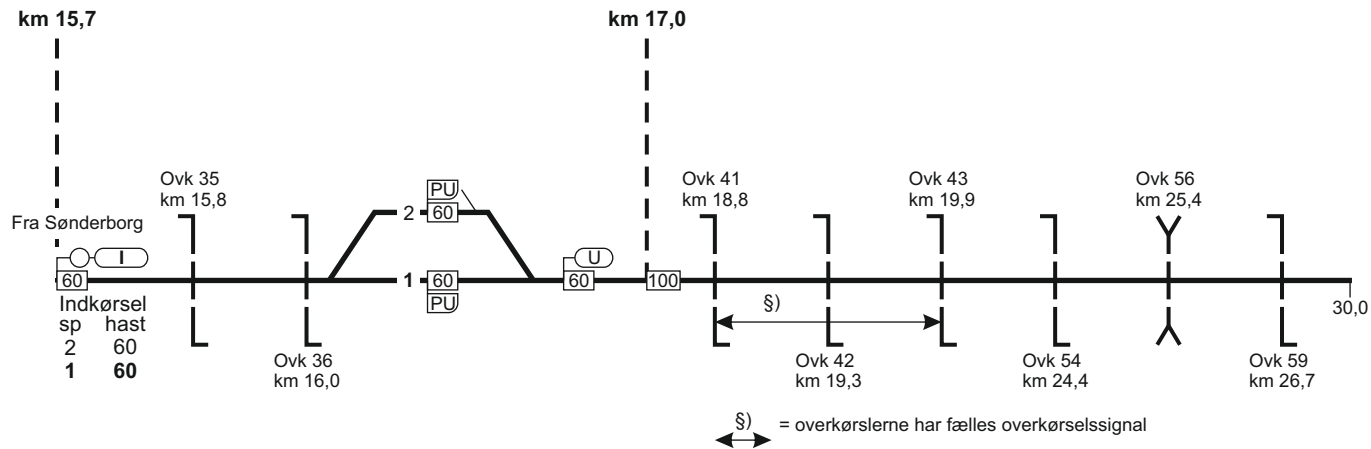

FC Fa Syd
linjeblok
stigning E

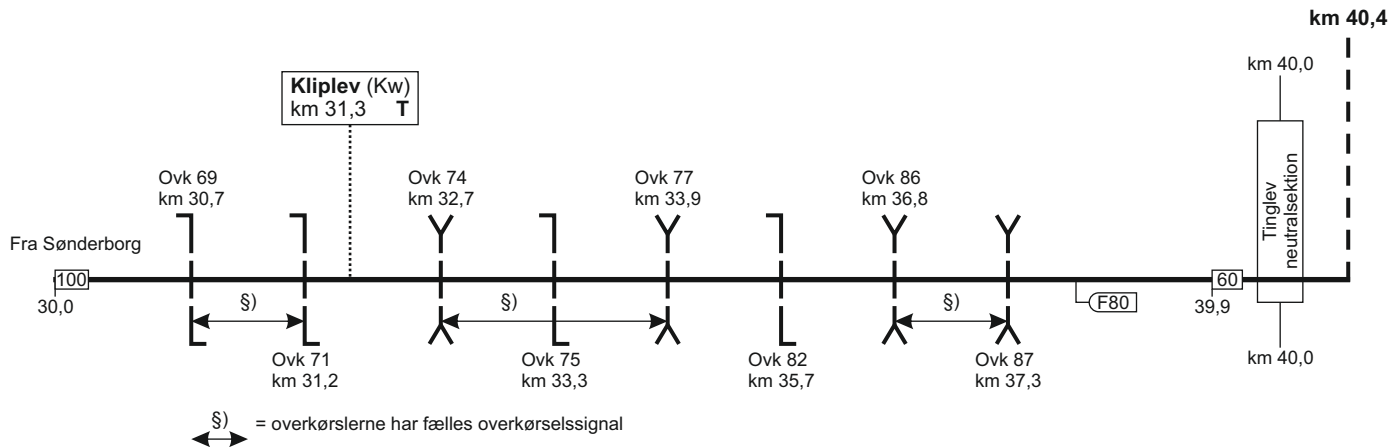

Tinglev (Te)
 km 41,2
 overgangsstation
 FC Fa
 ID: 67600

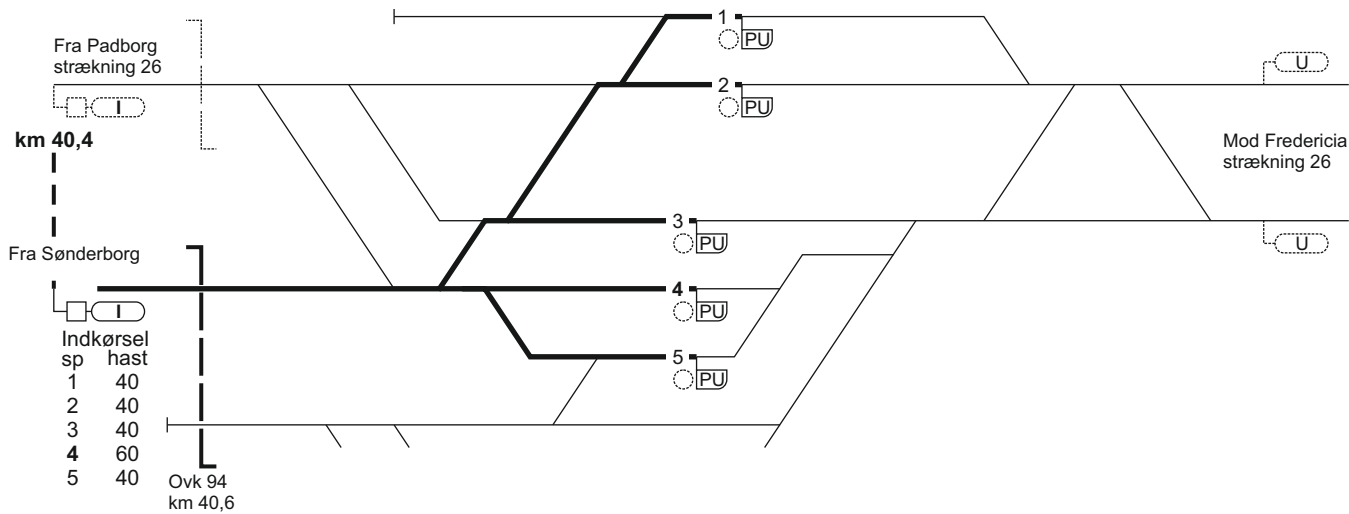

Tinglev (Te)
 km 41,2
 overgangsstation
 FC Fa
 ID: 67600

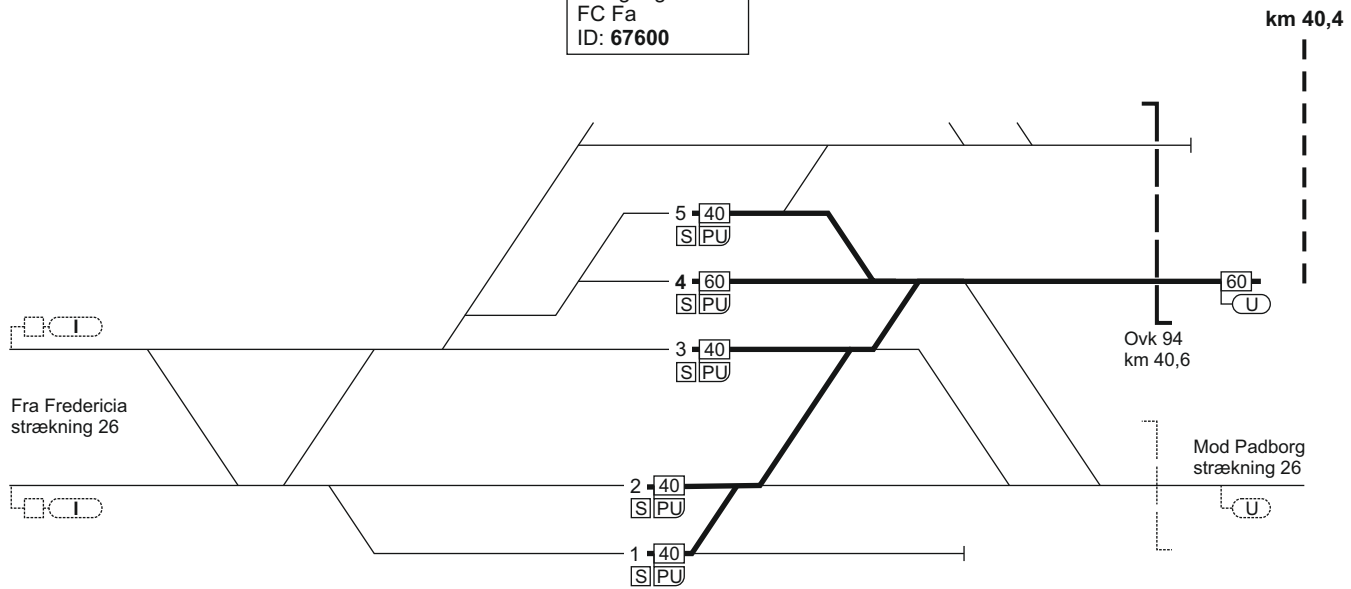

FC Fa Syd
linjeblok
stigning F

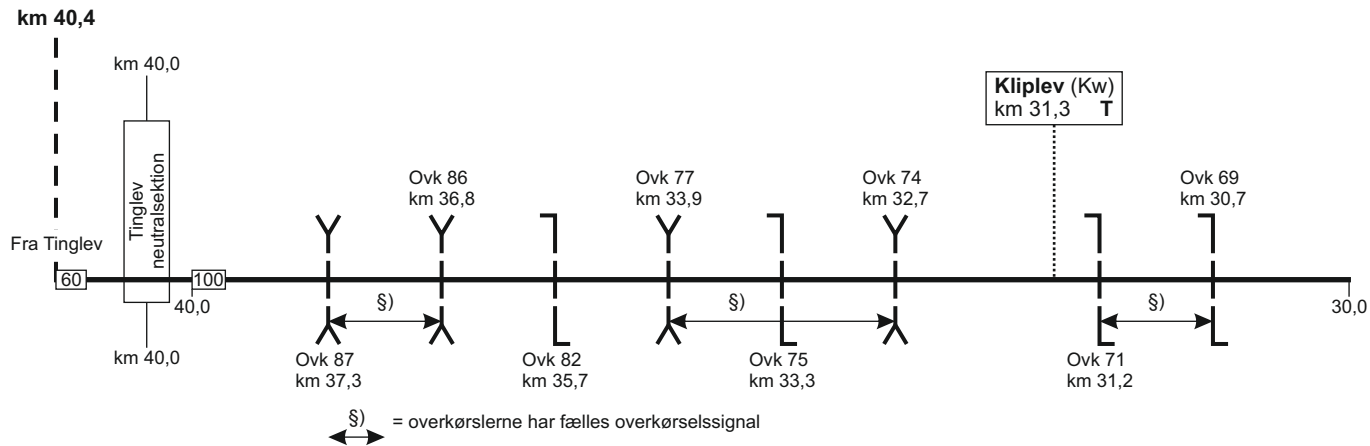

FC Fa Syd
linjeblok
stigning F

Gråsten (Gst)
km 16,3
FC Fa Syd

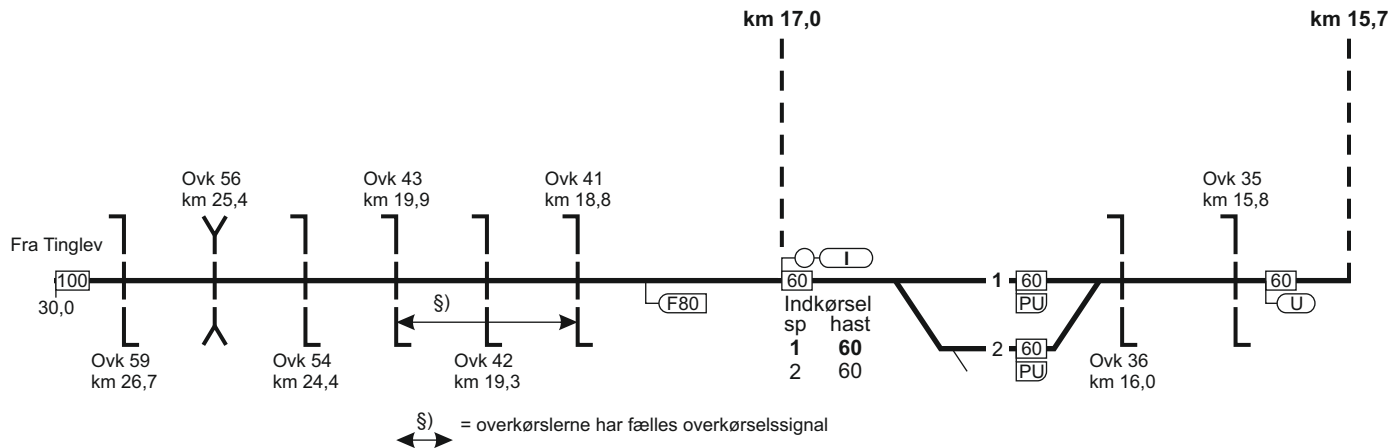

FC Fa Syd
linjeblok
stigning E

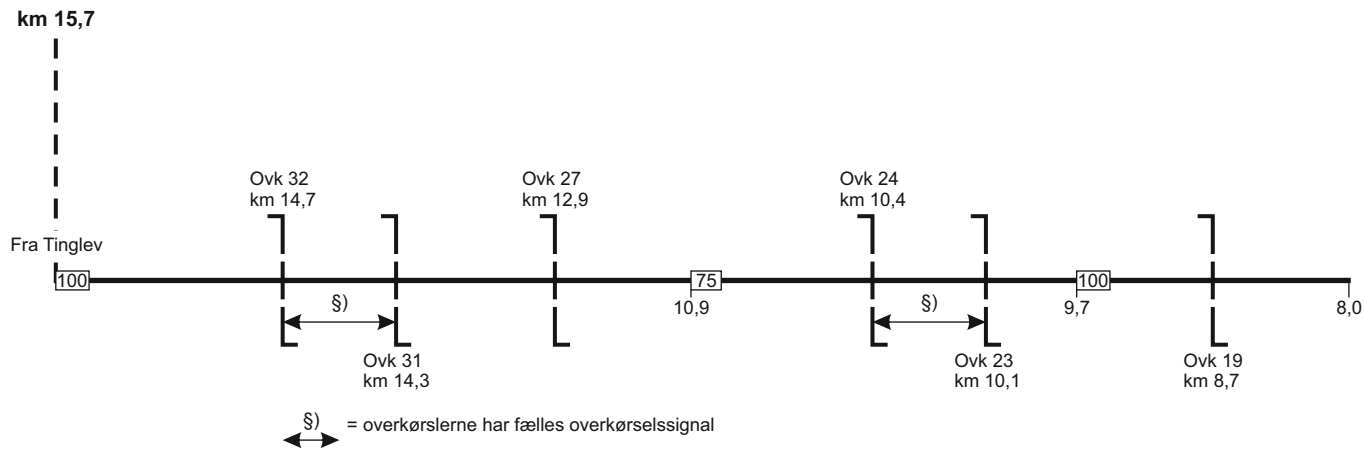

FC Fa Syd
linjeblok
stigning E

Sønderborg (Sdb)
km 0,0
FC Fa Syd

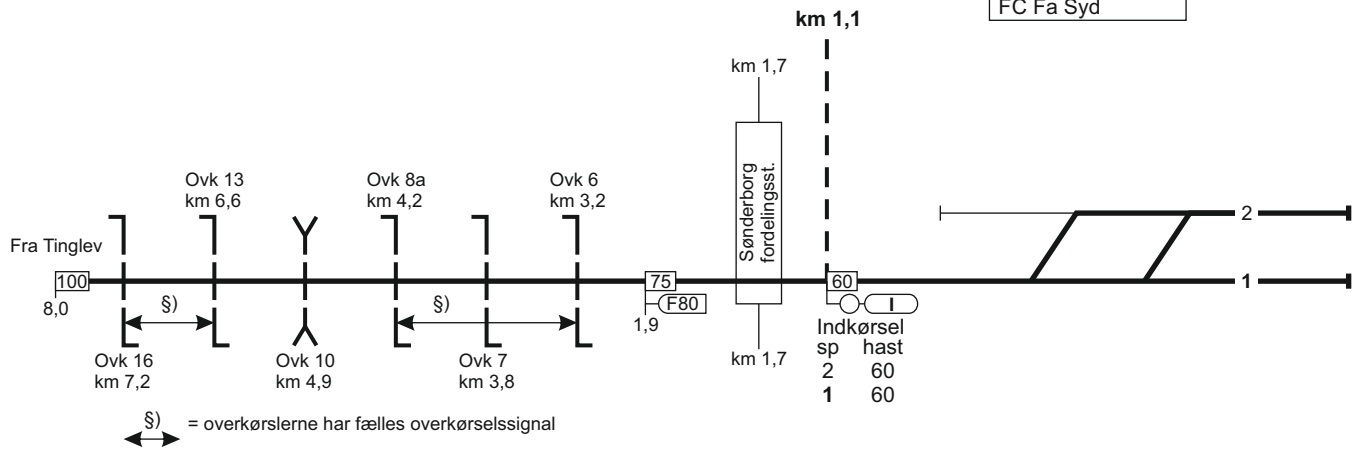

Togekspeditionssted 1	Togfølgestation 2	Sporbenyttelse 3	Standsningssted 4	Kmp/FC telefonnummer 5
Fredericia				FC: Sdb - Te 82 27 25 14 GSM-R: 81 99 12 28
Tinglev				GSM-R: 81 99 12 76

29. Lunderskov - (Vejen)

Strækningshastighed:

Delstrækning	Strækningshastighed (km/t)
Lunderskov - (Vejen)	180

FC Fa Vest
linjeblok / vekselspor
stigning J

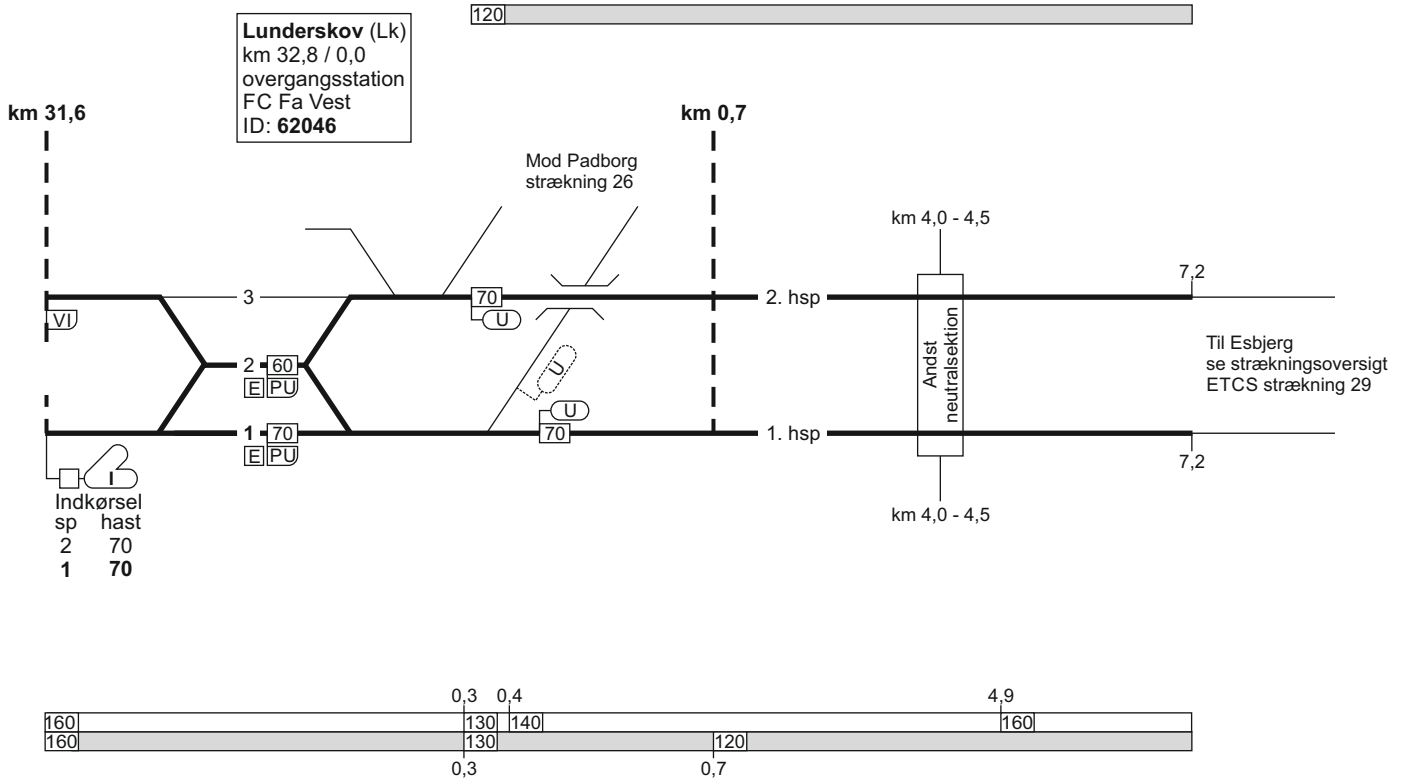

FC Fa Vest
linjeblok / vekselspor
stigning K

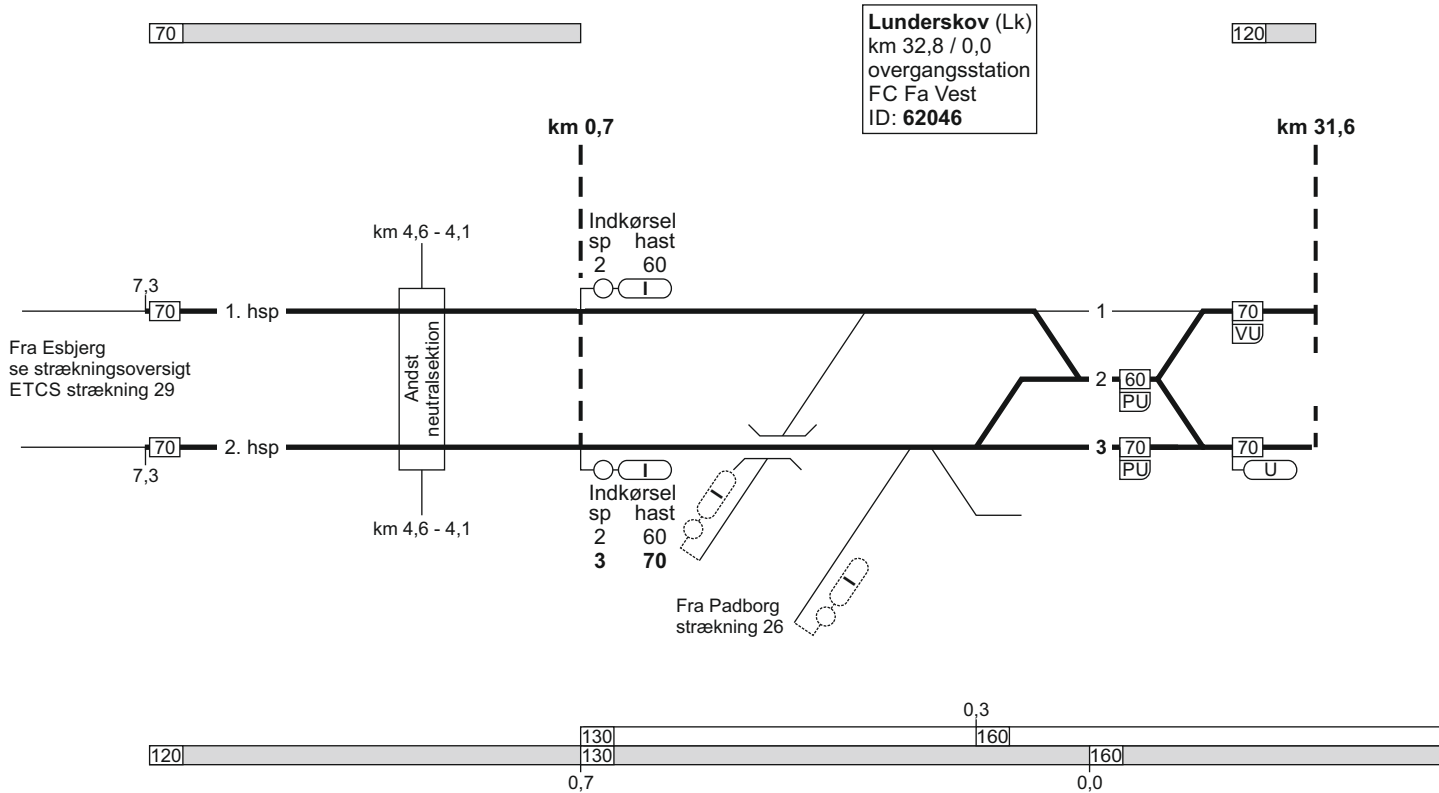

Togekspeditionssted 1	Togfølgestation 2	Sporbenyttelse 3	Standsningssted 4	Kmp/FC telefonnummer 5
Lunderskov				FC Fa: 82 27 25 15 GSM-R: 81 99 12 24

30. Tønder - Tønder Grænse**Strækningshastighed:**

Delstrækning	Strækningshastighed (km/t)
Tønder - Tønder Grænse	60

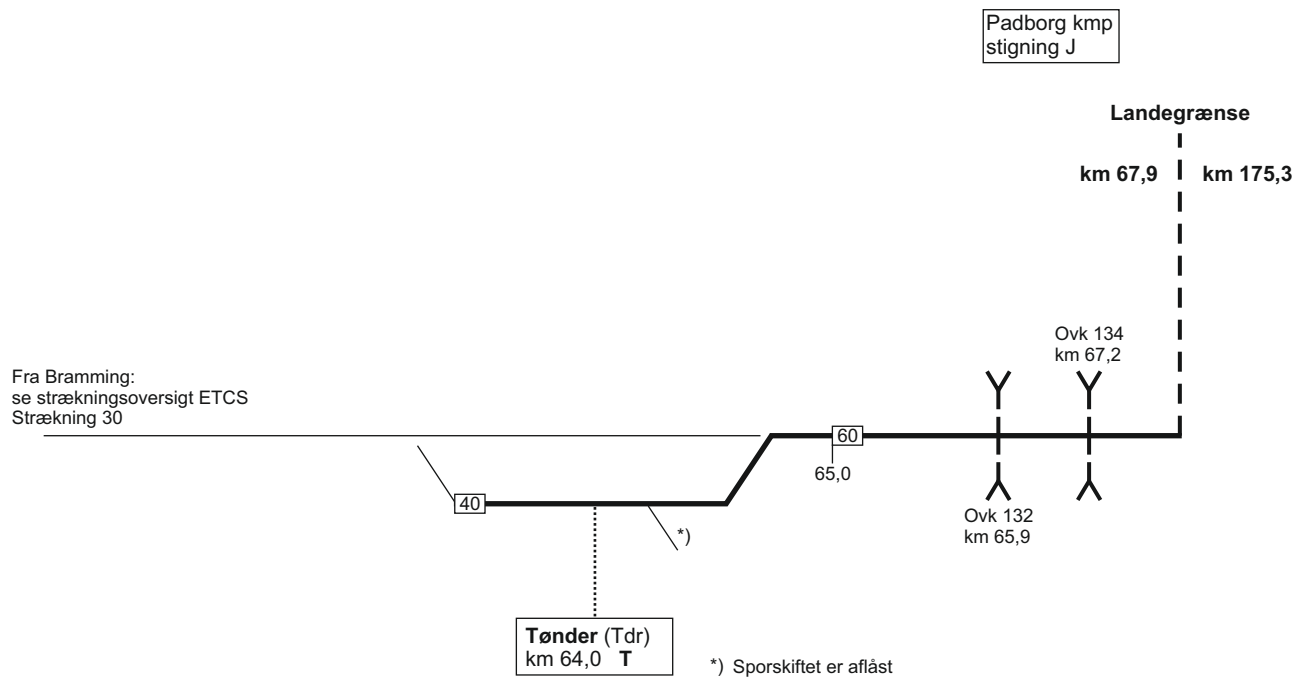

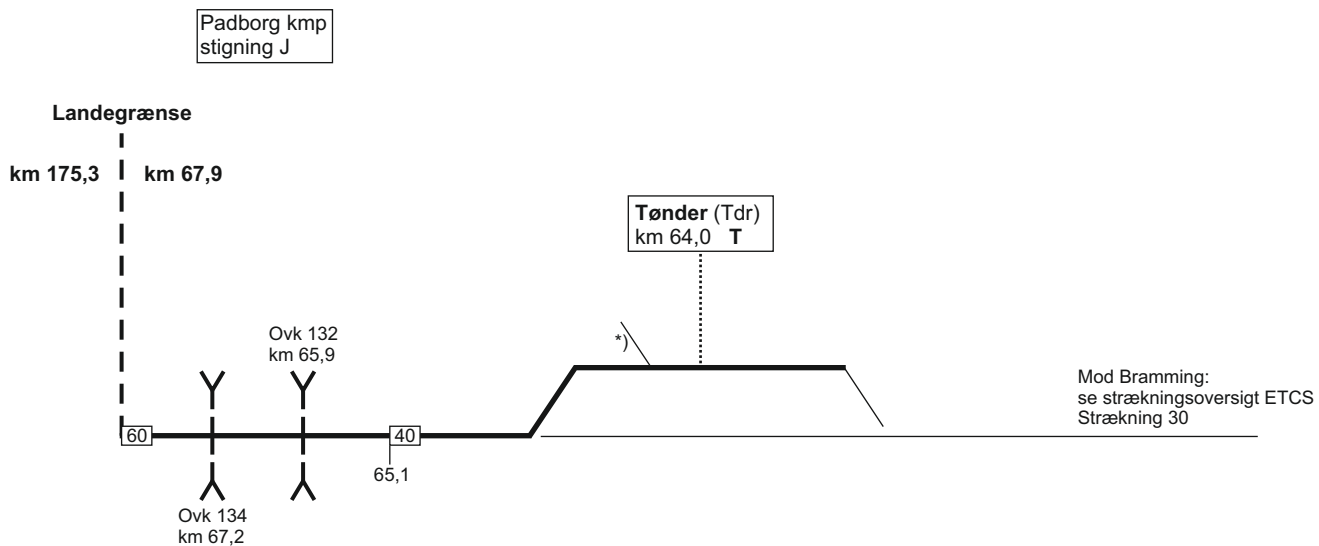

*) Sporskiftet er aflåst

Togekspeditionssted 1	Togfølgestation 2	Sporbenyttelse 3	Standsningssted 4	Kmp/FC telefonnummer 5
Padborg				FC: Tdr T – Tdr gr. 81991253